

NOTE: RIGHT OF WAY AND CENTERLINE  
INFORMATION TAKEN FROM CITY OF BOSTON  
GIS DATA

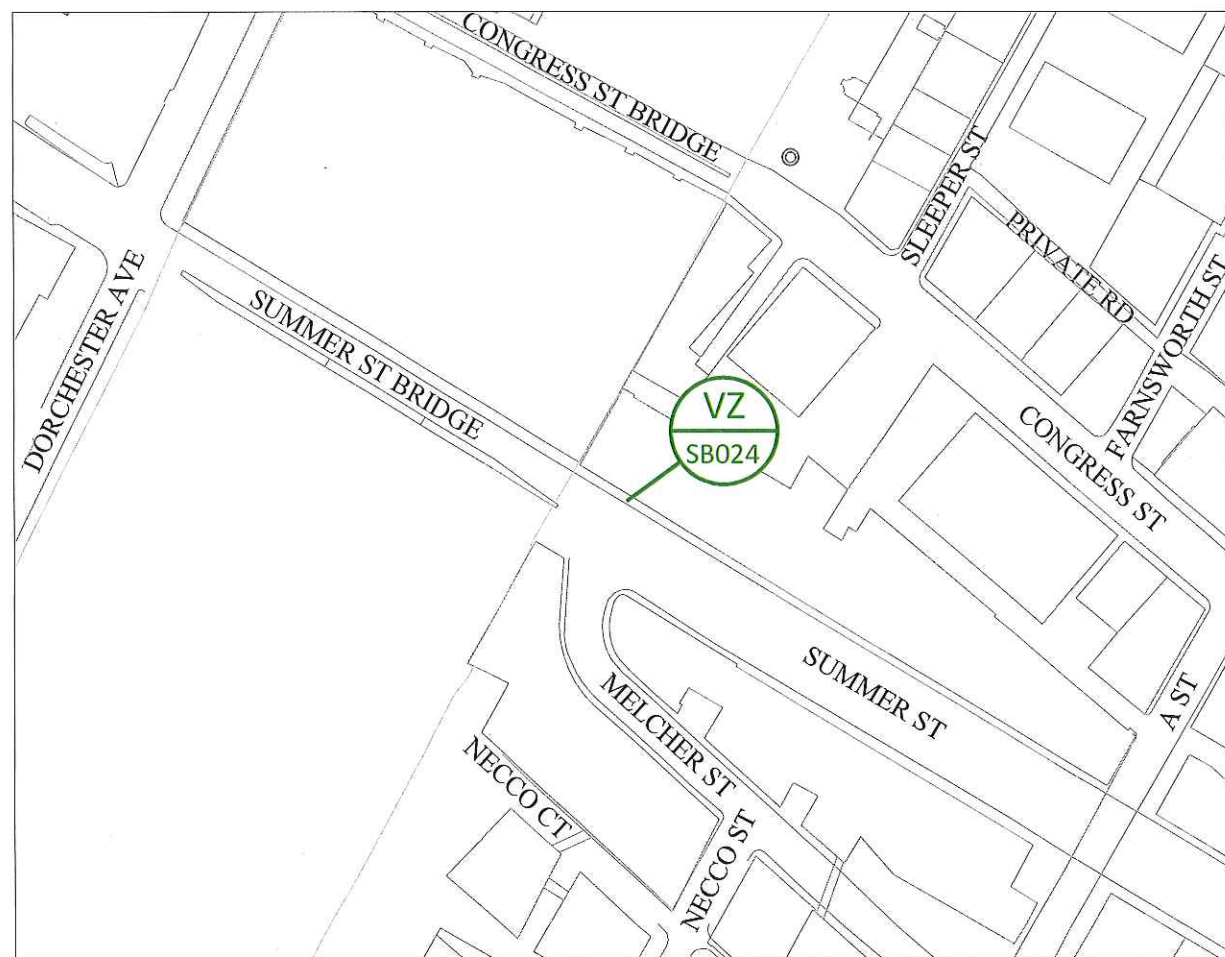

**CROWN CASTLE - BOSTON, MA - 02210**  
**NODE POLE PROFILE - SB024**  
**CITY OF BOSTON, SUFFOLK COUNTY, MASSACHUSETTS**



**LOCATION MAP**  
 LATITUDE: 42.350648 LONGITUDE: -71.050907  
 SCALE: 1" = 200'

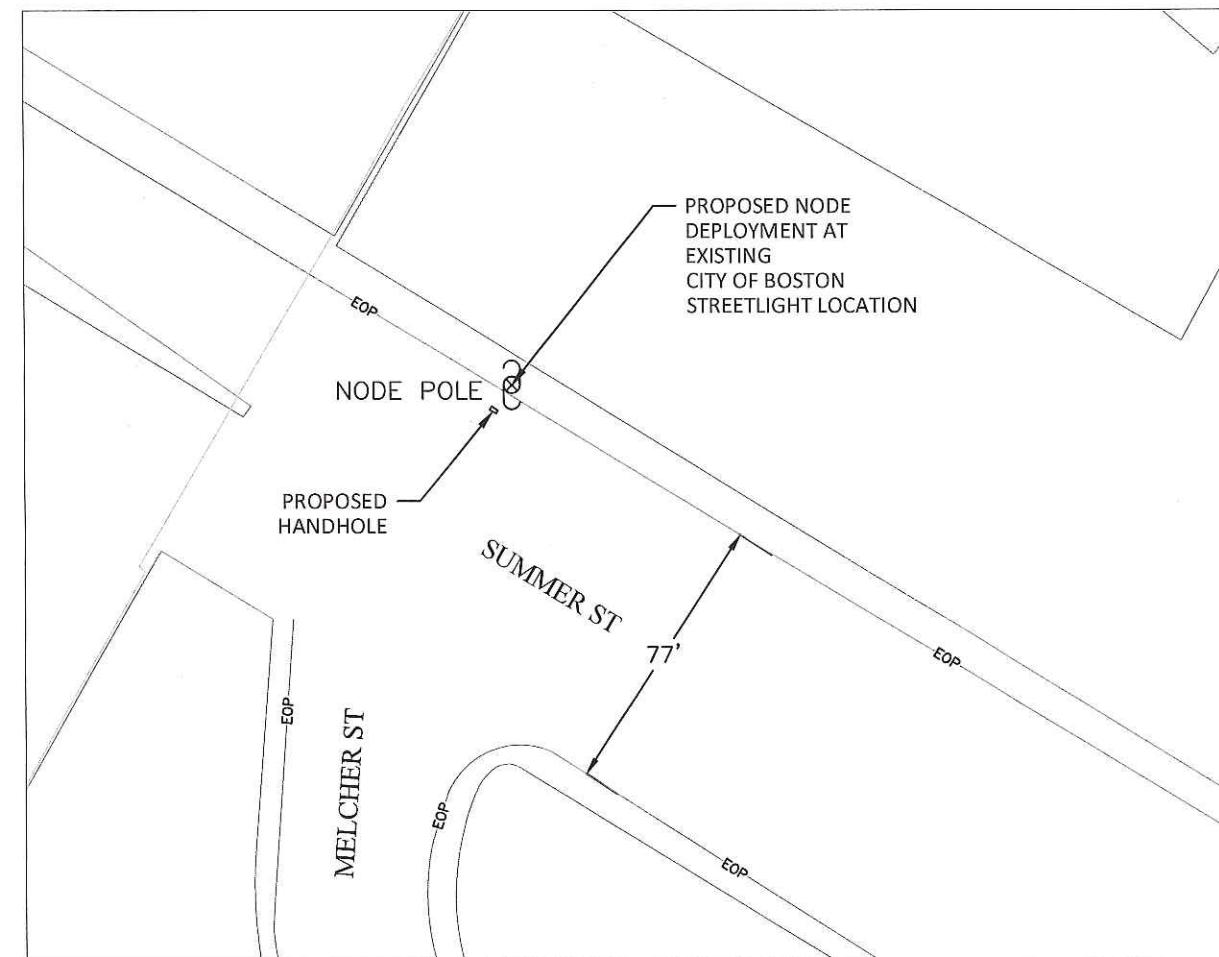

**PROPOSED NODE PLACEMENT**  
 PROJECT LOCATION - SITE# VZ-SB024  
 SCALE: 1" = 50'

PREPARED BY: <b>UC SYNERGETIC</b> <i>Innovative Thinking. Engineered Solutions.</i> 21 OXFORD RD MANSFIELD, MA 02048 www.ucseng.com 1-508-337-7600	TITLE: <b>SB024</b> STREET LIGHT POLE REPLACEMENT BOSTON, MA	
	POLE INFO: CONCRETE POLE	
PREPARED FOR: 	SURVEYED BY: UCS	PRINT NO: 1 OF 3
	DRAWN BY: VMF	SCALE: AS SHOWN
	ISSUE DATE: 9/30/15	AS BUILT:

**CROWN CASTLE - BOSTON, MA - 02210**  
**NODE POLE PROFILE - SB024**  
**CITY OF BOSTON, SUFFOLK COUNTY, MASSACHUSETTS**

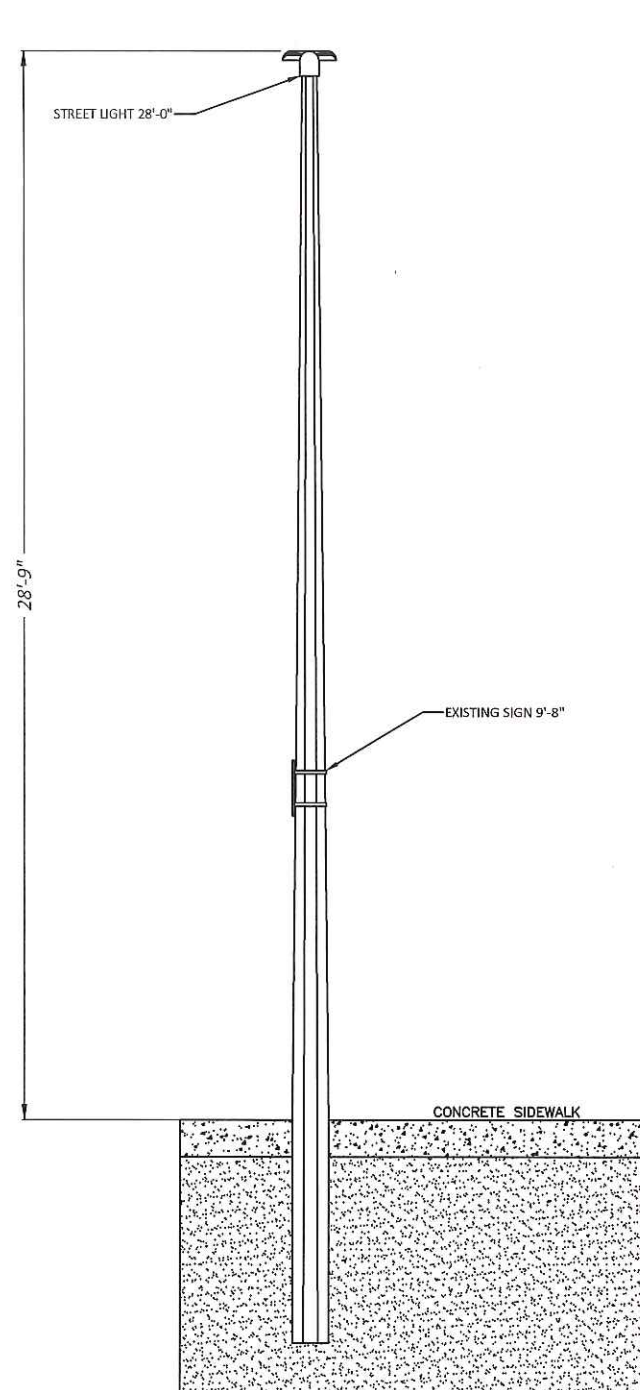

POLE DIAGRAM  
REAR VIEW

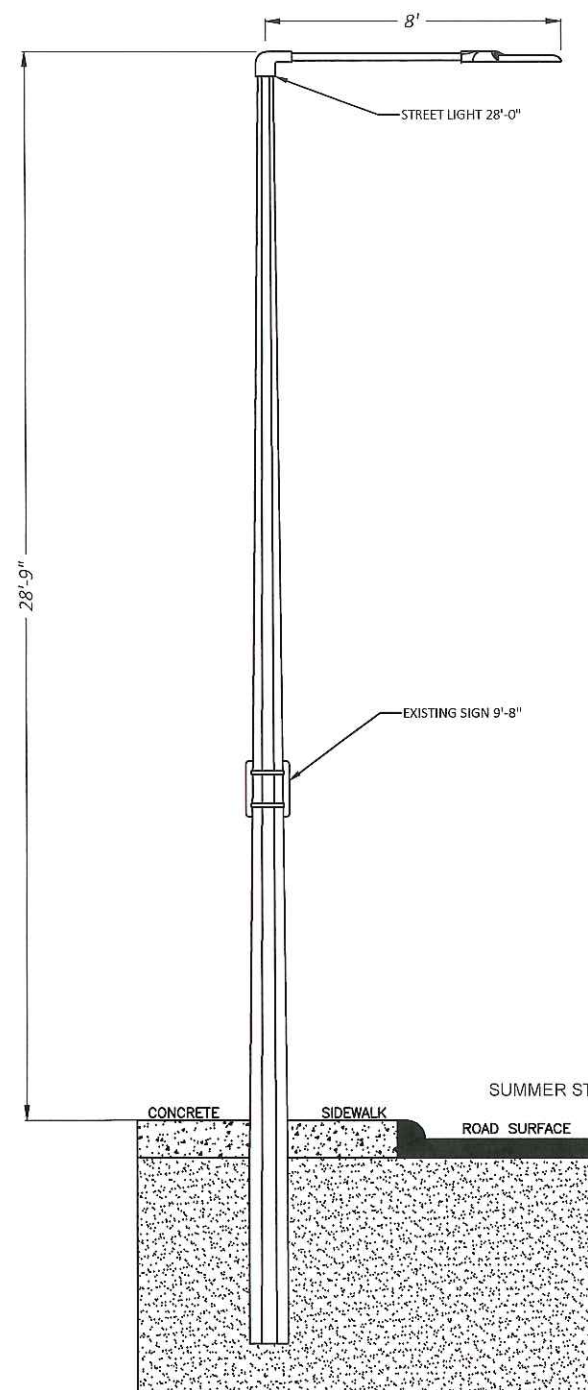

POLE DIAGRAM  
SIDE VIEW

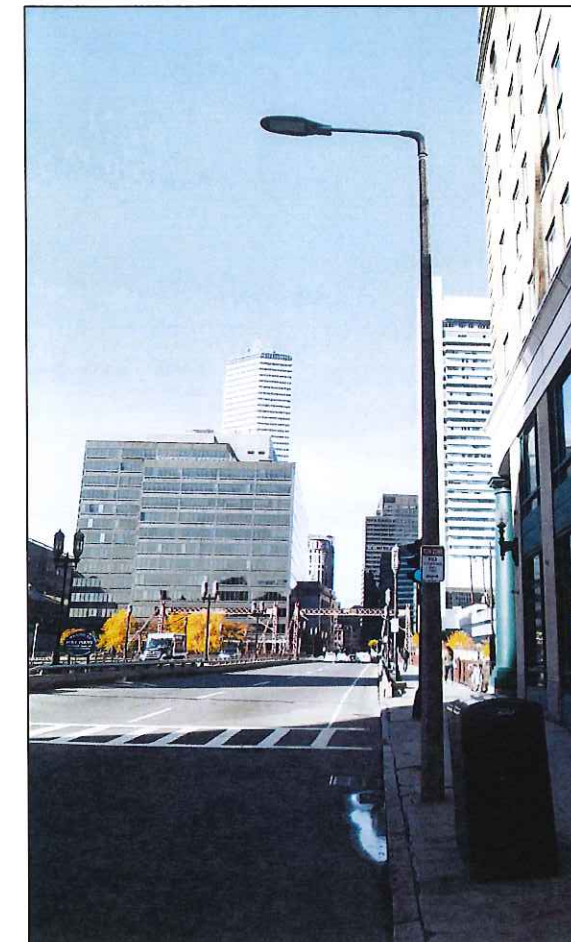
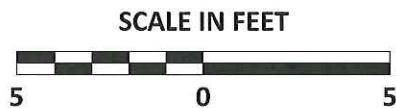

11/17/2016 N:\Engineering\Crown Castle\AZ Wireless - Seaport 305074\MA-AUTOCAD\NODE POLE PROFILES\NODE 024.dwg

REVISIONS		
REV	DESCRIPTION	DATE
1	REMOVED STREET LIGHT	01/26/16
2	LOCATION CHANGE	WP 11/16/16

PREPARED BY: <b>UC SYNERGETIC</b> <i>Innovative Thinking. Engineered Solutions.</i> 21 OXFORD RD MANSFIELD, MA 02048 www.ucseng.com 1-508-337-7600	TITLE: <b>SB024</b> EXISTING EQUIPMENT POLE PROFILES BOSTON, MA
PREPARED FOR: <b>CROWN CASTLE</b>	POLE INFO: CONCRETE POLE
SURVEYED BY: UCS	PRINT NO: 2 OF 3
DRAWN BY: VMF	SCALE:
ISSUE DATE: 9/30/15	AS BUILT: AS SHOWN



NOTE:  
PER CUSTOMER ENGINEERING ANALYSIS THIS DEPTH IS  
ADEQUATE FOR THE SPECIFIED POLE AND EQUIPMENT

# CROWN CASTLE - BOSTON, MA - 02210

## NODE POLE PROFILE - SB024

### CITY OF BOSTON, SUFFOLK COUNTY, MASSACHUSETTS

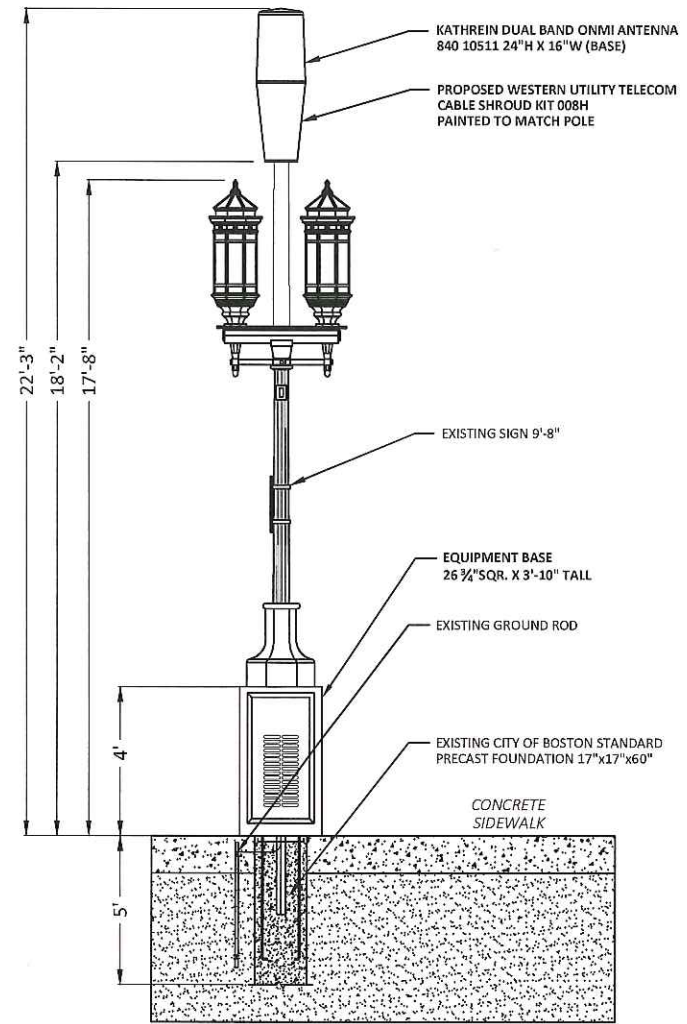

POLE DIAGRAM REAR VIEW

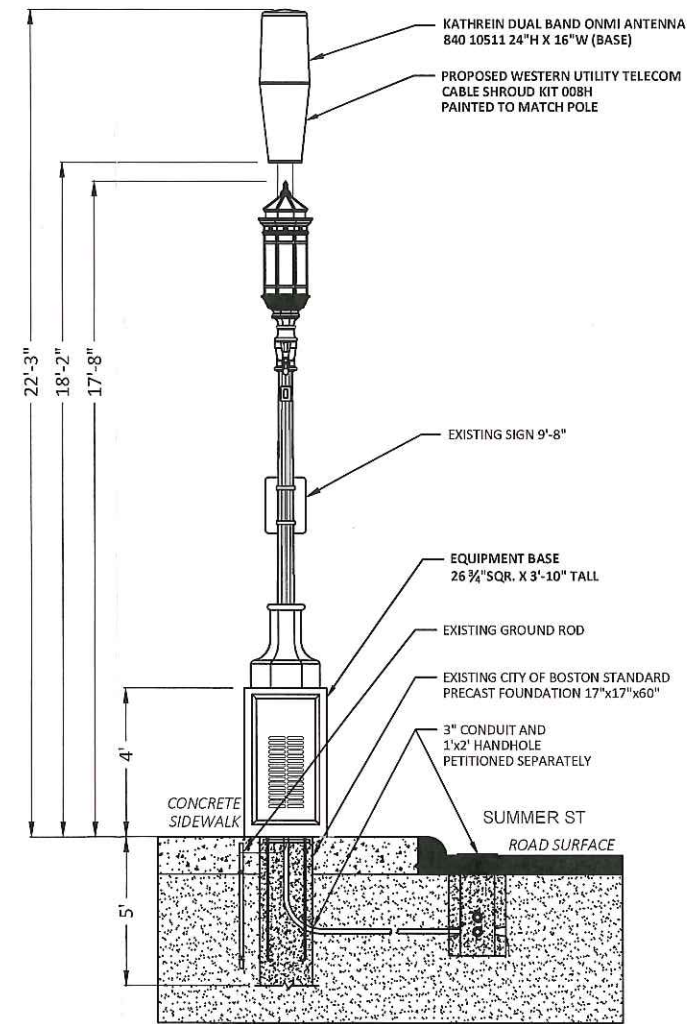

POLE DIAGRAM SIDE VIEW

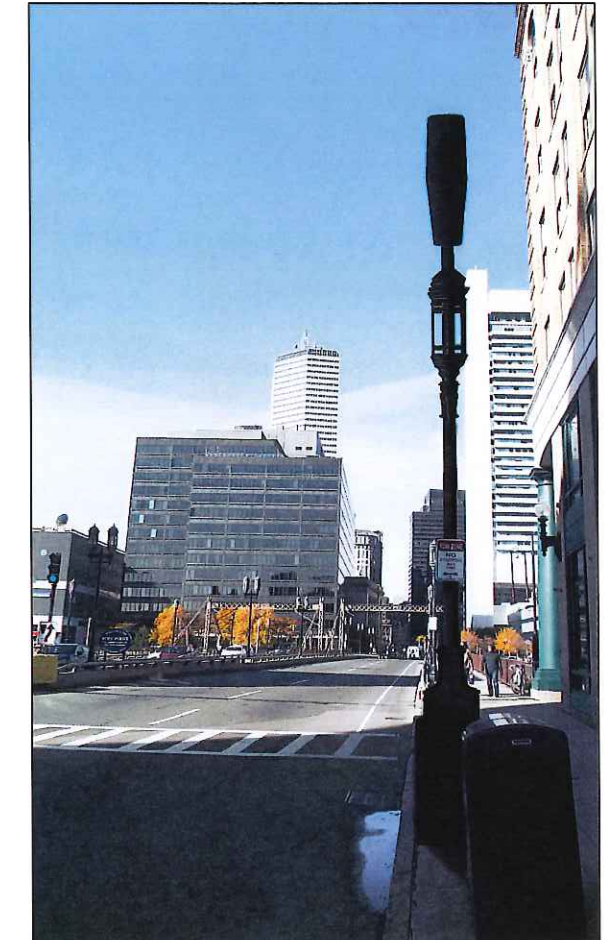
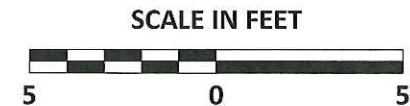

11/17/2016 N:\Engineering\Crown Castle\Wireless - Support\305074\AA - AUTOCAD\NODE POLE PROFILES\NODE 024.dwg

REVISIONS		
REV	DESCRIPTION	DATE
1	REMOVED STREET LIGHT	01/26/16
2	LOCATION CHANGE	WP 11/16/16

PREPARED BY: 21 OXFORD RD MANSFIELD, MA 02048 www.ucseeng.com 3-508-337-7600	TITLE: <b>SB024</b> P.NT PROPOSED EQUIPMENT POLE PROFILES
PREPARED FOR: 	POLE INFO: CONCRETE POLE SURVEYED BY: UCS DRAWN BY: VMF ISSUE DATE: 9/30/15
PRINT NO: 3 OF 3 SCALE: AS BUILT: AS SHOWN	

NOTE: RIGHT OF WAY AND CENTERLINE  
INFORMATION TAKEN FROM CITY OF BOSTON  
GIS DATA

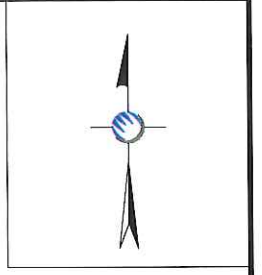

**CROWN CASTLE - BOSTON, MA - 02210**  
**NODE POLE PROFILE - SB034**  
**CITY OF BOSTON, SUFFOLK COUNTY, MASSACHUSETTS**

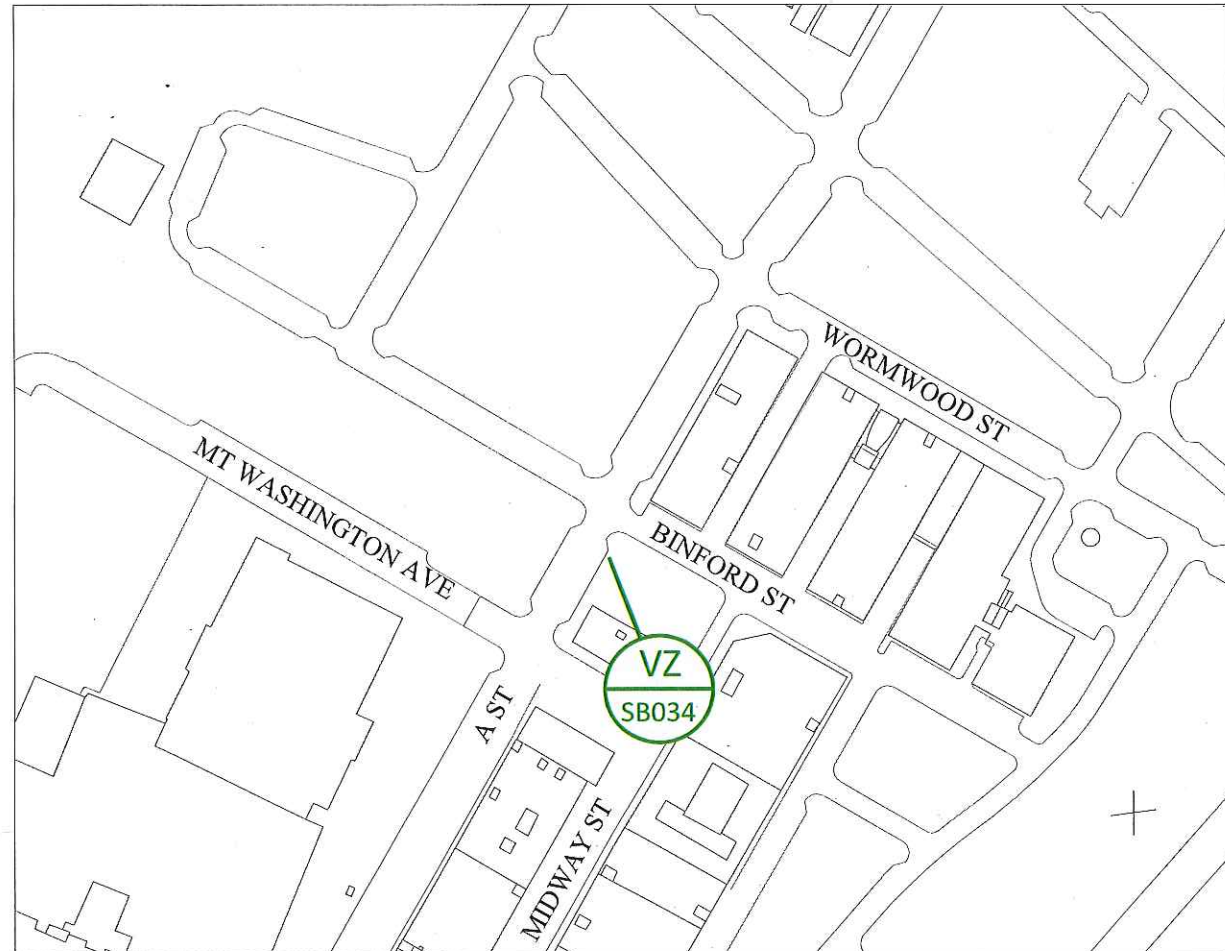

**LOCATION MAP**  
 LATITUDE: 42.346824 LONGITUDE: -71.051140  
 SCALE: 1" = 200'

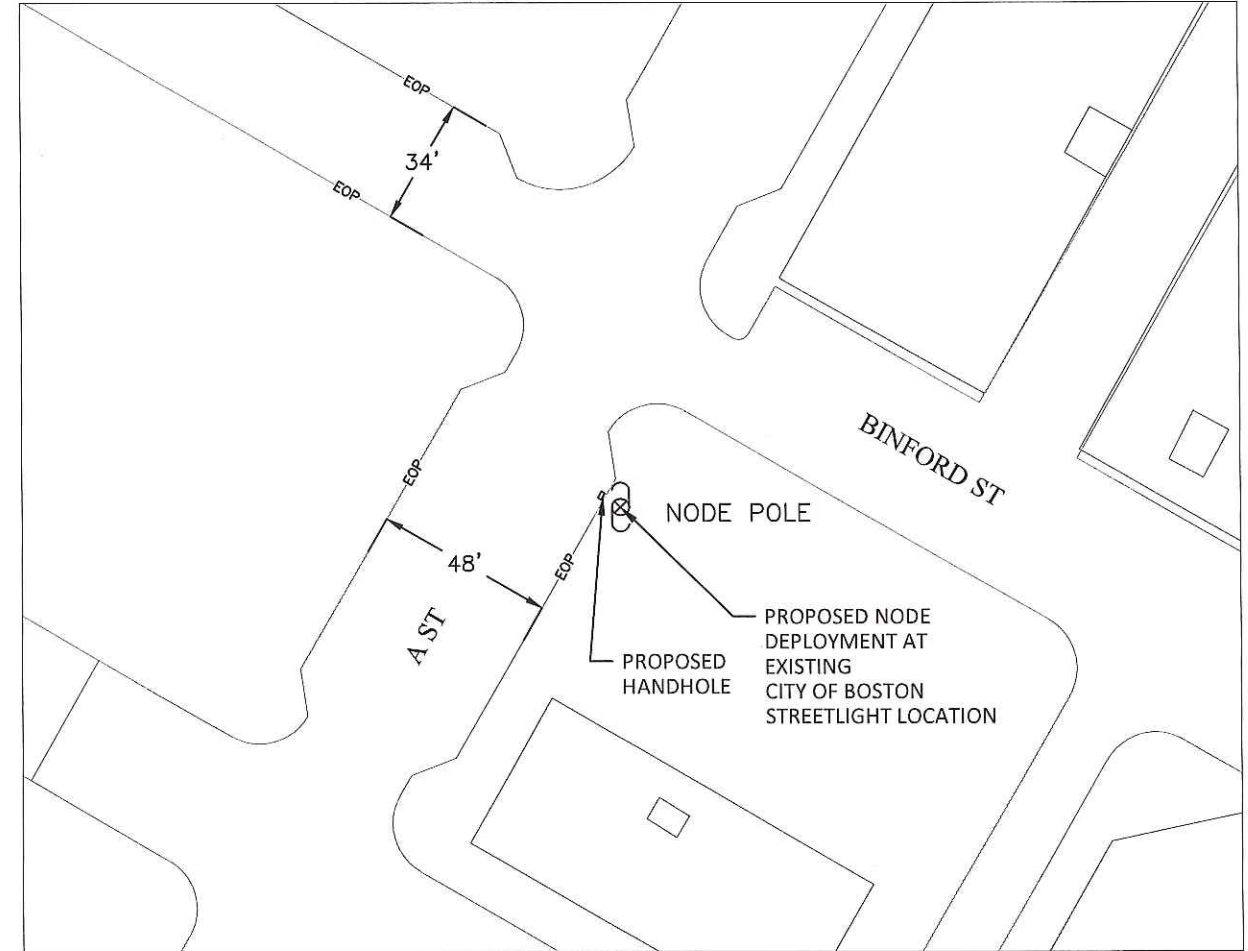

**PROPOSED NODE PLACEMENT**  
 PROJECT LOCATION - SITE# VZ-SB034  
 SCALE: 1" = 50'

PREPARED BY: <b>UC SYNERGETIC</b> <i>Innovative Thinking. Engineered Solutions.</i> 21 OXFORD RD MANSFIELD, MA 02048 www.ucsceng.com 1-508-337-7600	TITLE: <b>SB034</b> STREET LIGHT POLE REPLACEMENT BOSTON, MA	
	POLE INFO: CONCRETE POLE	
PREPARED FOR: 	SURVEYED BY: UCS	PRINT NO: 1 OF 4
	DRAWN BY: SJK	SCALE: AS NOTED
	ISSUE DATE: 08/11/15	AS BUILT:



**CROWN CASTLE - BOSTON, MA - 02210**  
**NODE POLE PROFILE - SB034**  
**CITY OF BOSTON, SUFFOLK COUNTY, MASSACHUSETTS**

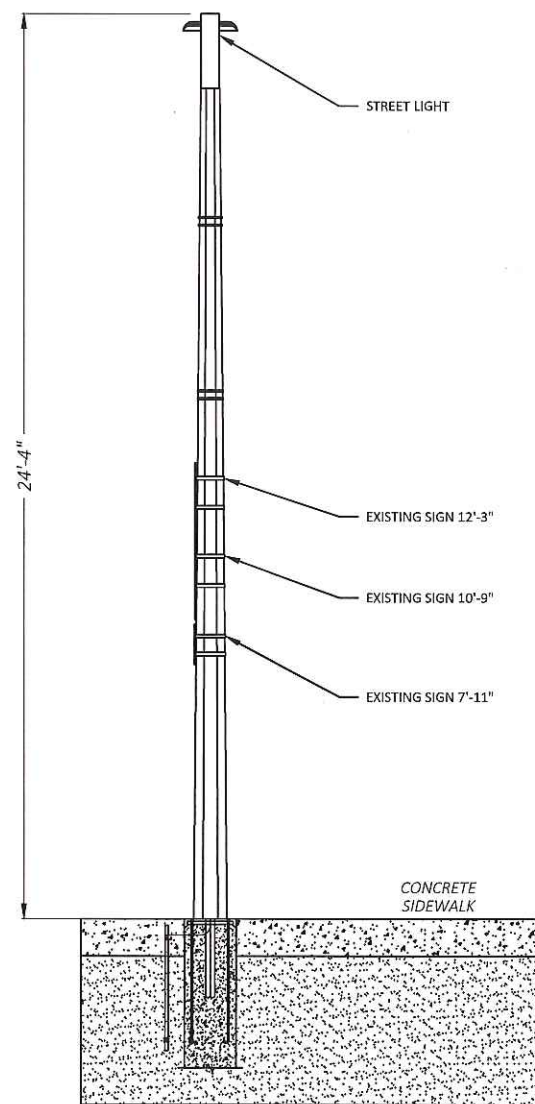

POLE DIAGRAM  
REAR VIEW

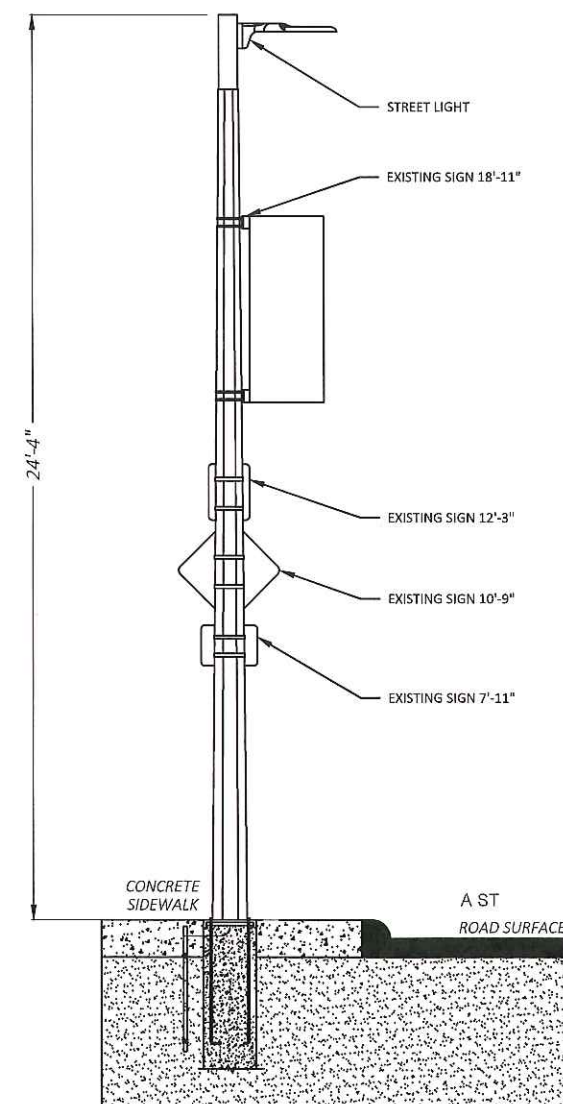

POLE DIAGRAM  
SIDE VIEW

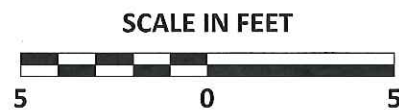

REVISIONS		
REV	DESCRIPTION	DATE
1	UPDATED SHROUD & BASE	12/15/15
2	UPDATED PROPOSED LIGHT FIXTURE	6/24/16

PREPARED BY: <b>UC SYNERGETIC</b> <small>Innovative Thinking. Engineered Solutions.</small> 21 OXFORD RD MANSFIELD, MA 02048 www.ucseng.com 1-508-337-7600	TITLE: <b>SB034</b> EXISTING EQUIPMENT POLE PROFILES BOSTON, MA
PREPARED FOR: <b>CROWN CASTLE</b>	POLE INFO: CONCRETE POLE
SURVEYED BY: UCS	PRINT NO: 2 OF 4
DRAWN BY: SJK	SCALE: AS NOTED
ISSUE DATE: 08/11/15	AS BUILT:

06/24/16 N:\Engineering\Crown Castle\WZ Wireless - Support\305074\AA-AUTOCAD\NODE POLE PROFILES\NODE 034.dwg

# CROWN CASTLE - BOSTON, MA - 02210

## NODE POLE PROFILE - SB034

### CITY OF BOSTON, SUFFOLK COUNTY, MASSACHUSETTS

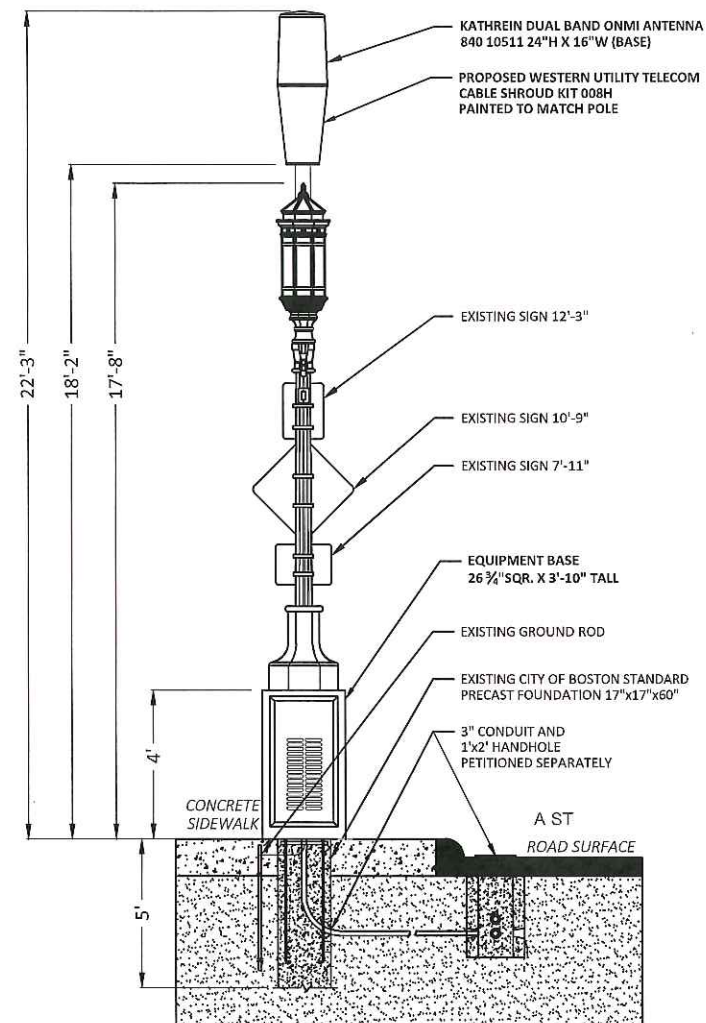
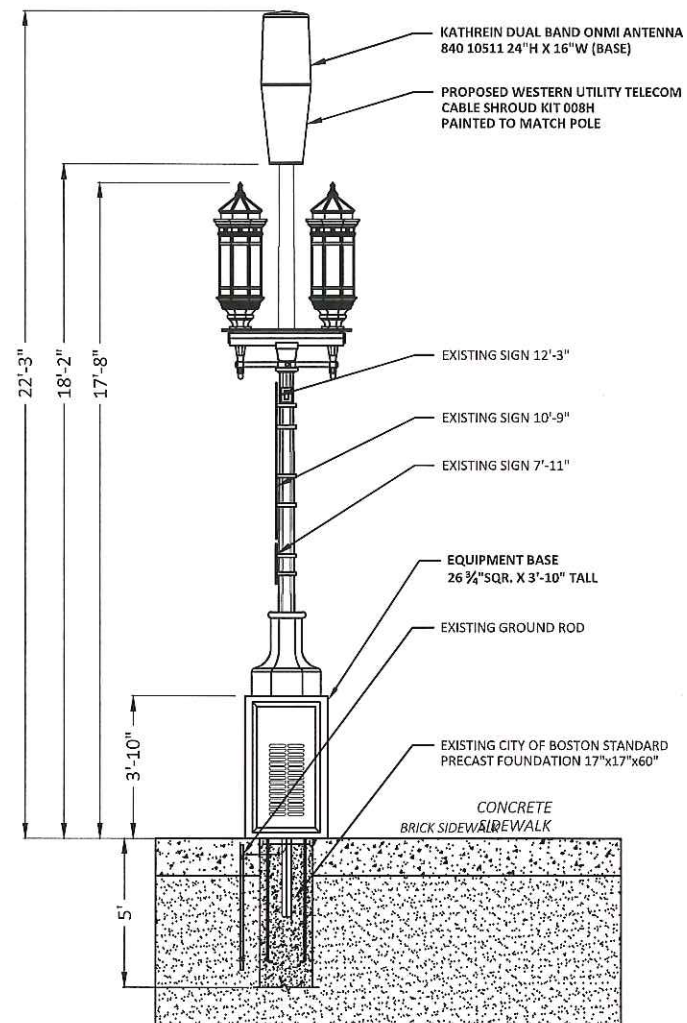

POLE DIAGRAM REAR VIEW

POLE DIAGRAM SIDE VIEW

SCALE IN FEET

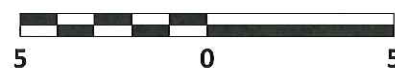

06/24/16 N:\Engineering\Crown Castle\12 Wireless - Support\305074\AA-AUTOCAD\NODE POLE PROFILE\NODE SB034.dwg

REVISIONS		
REV	DESCRIPTION	DATE
1	UPDATED SHROUD & BASE	12/15/15
2	UPDATED PROPOSED LIGHT FIXTURE	6/24/16

PREPARED BY: <b>UC SYNERGETIC</b> <small>Innovative Thinking. Engineered Solutions.</small> 21 OXFORD RD MANSFIELD, MA 02048 www.uceng.com 1-508-337-7600	TITLE: <b>SB034</b> P,NT PROPOSED EQUIPMENT POLE PROFILES
PREPARED FOR: <b>CROWN CASTLE</b>	POLE INFO: CONCRETE POLE
SURVEYED BY: UCS	PRINT NO: 3 OF 4
DRAWN BY: SJK	SCALE: AS NOTED
ISSUE DATE: 08/11/15	AS BUILT: AS SHOWN





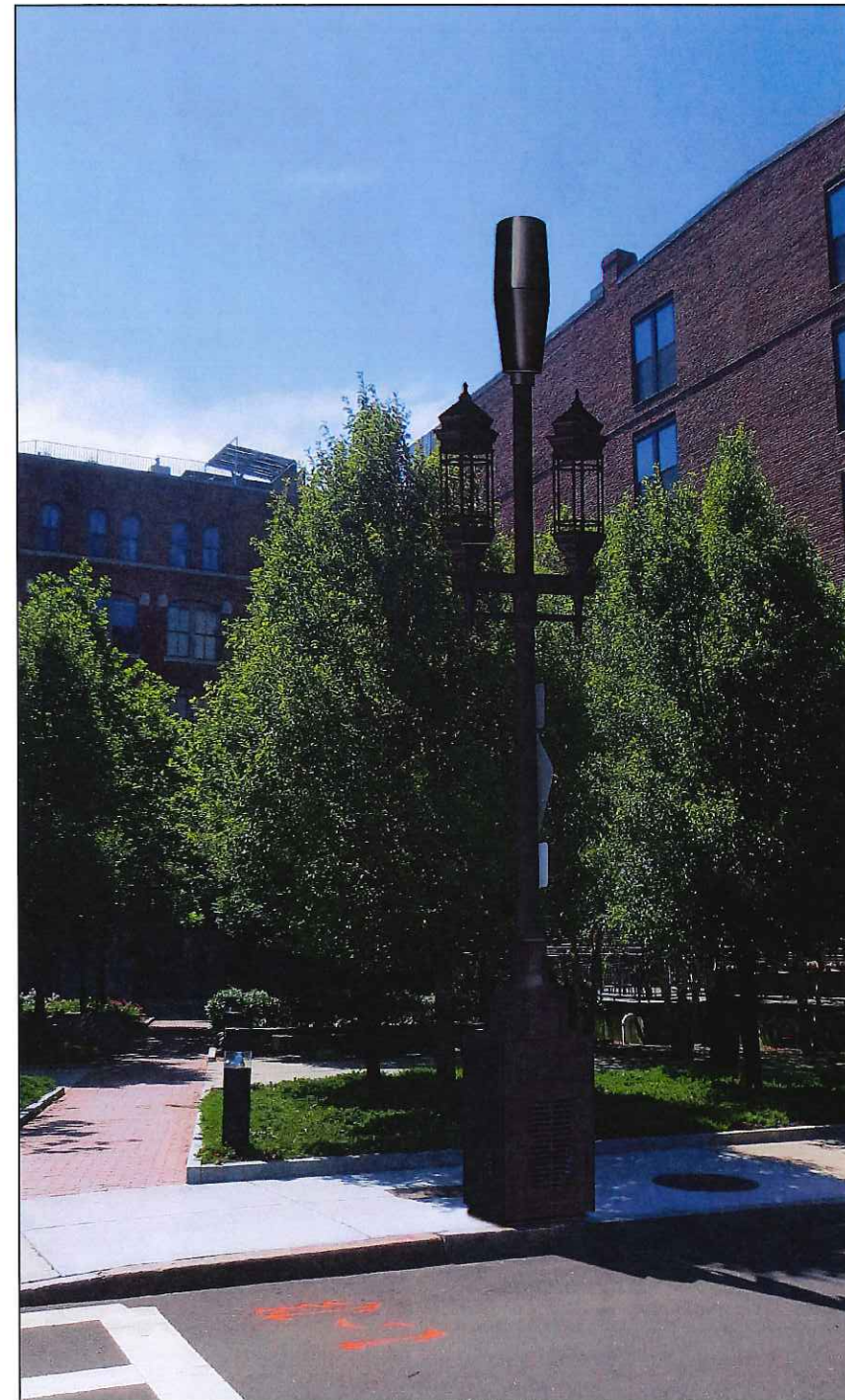

PHOTOGRAPHIC SIMULATION



PHOTOGRAPHIC SIMULATION

06/24/16 N:\Engineering\Crown Castle\WZ Wireless - Seaport-305074\AA-AUTOCAD\NODE POLE PROFILES\NODE 034.dwg

REVISIONS		
REV	DESCRIPTION	DATE
1	UPDATED SHROUD & BASE	12/15/15
2	UPDATED PROPOSED LIGHT FIXTURE	6/24/16

PREPARED BY:  <i>Innovative Thinking. Engineered Solutions.</i> 21 OXFORD RD MANSFIELD, MA 02048 www.uc seng.com 1-508-337-7600	TITLE: <b>SB034</b> P.NT PROPOSED EQUIPMENT POLE PROFILES
PREPARED FOR: 	POLE INFO: CONCRETE POLE
SURVEYED BY: UCS	PRINT NO: 4 OF 4
DRAWN BY: SJK	SCALE: AS NOTED
ISSUE DATE: 08/11/15	AS BUILT: AS SHOWN