

Notice of Intent



February 2021

MCCONNELL PLAYGROUND IMPROVEMENTS

PREPARED FOR:
CITY OF BOSTON

SUBMITTED TO:
BOSTON CONSERVATION COMMISSION



Checklist for Filing a Notice of Intent with Boston Conservation Commission

In order for the Boston Conservation Commission to effectively process your Notice of Intent, BCC requests that you complete the checklist below and include it with your submission. If you should need assistance please contact Commission Staff: 617-635-3850 (cc@boston.gov).

Please Submit the Following to the Conservation Commission:

- Two copies (a signed original and 1 copy) of a completed Notice of Intent (WPA Form 3)
- Two copies (a signed original and 1 copy) of a completed Boston Notice of Intent (Local Form)
- Two copies of plans (reduced to 11" X 17") in their final form with engineer's stamp affixed supporting calculations and other documentation necessary to completely describe the proposed work and mitigating measures. Plans must include existing conditions, the proposed project, erosion controls and mitigation measures, grading and spot elevations and all wetland resource areas and associated buffer zones. Some projects may require both an aerial view of the plans along with a profile view of plans depending on the scope of work.
- Two copies of an 8 ½" x 11" section of the [USGS quadrangle map](#) of the area, containing sufficient information for the Conservation Commission and the Department to locate the site of the work.
- (If applicable) Two copies the Federal Emergency Management Agency Flood Insurance Rate Map for the project site. FEMA Flood Maps: <https://msc.fema.gov/portal>.
- Two copies of the determination regarding the Natural Heritage and Endangered Species Program: Review Section C. Other Applicable Standards and Requirements of the Notice of Intent, page 4 of 8, pertaining to wildlife habitat. The Conservation Commission and the [Natural Heritage & Endangered Species Program](#) have the maps necessary to make this determination.
- (If applicable) Two hard copies of a Stormwater Report to document compliance with the Stormwater Management Standards per 310 CMR 10.05(6)(k)-(q), including associated drainage calculations for rooftops, parking lots, driveways, etc., for the required design storm events.
- (If applicable) A narrative detailing best management practices for stormwater management as set forth in the Stormwater Management Standards of the Massachusetts Department of Environmental Protection and any separate standards and guidelines prepared by the City and the Boston Water and Sewer Commission.
- (If applicable) Two hard copies of the Checklist for Stormwater Report
- Details of the stormwater management system, including: catch basins, oil separating tanks, detention basins, outfalls, sewer connections, etc.
- Any photographs related to the project representing the wetland resource areas.
- Two copies of a detailed project narrative describing the following: an overview of the entire project, the work proposed within wetland resource areas and/or buffer zones; how the performance standards specific to the wetland resource areas will be met (listing out each performance standard); a consideration of the effect that projected sea level rise, changes in storm intensity and frequency, and other consequences of climate change may have on the resource areas and proposed activities; construction equipment and material involved; and measures to protect wetland resource areas and mitigate impacts. The applicant shall also include narrative on how they plan to integrate climate change and adaptation planning considerations into their project to promote climate resilience to protect and promote Resource Area Values and functions into the future.
- Two copies of an Abutters List, Affidavit of Service and [Abutter Notification](#), filed concurrently with the Notice of Intent. Abutter notices shall be sent in both English and the second most commonly spoken language(s) in the neighborhood(s) where the project is proposed. Notices shall also include Babel notice cards for additional translation and language access services. [All abutters within 300' of the project](#)

Checklist for Filing a Notice of Intent with Boston Conservation Commission

[property line](#) must be notified including those in a neighboring municipality. In such an instance, a copy of the filing must also be sent to the local Conservation Commission of the neighboring municipality.
EXCEPTION: When work is in land under water bodies and waterways or on a tract of land greater than 50 acres, written notification must only be given to abutters within 300 feet of the “project site.”

Two copies of the BPDA Climate Resiliency Checklist (for new buildings). This can be completed online at <http://www.bostonplans.org/planning/planning-initiatives/article-37-green-building-guidelines>. Please print the pdf that you will receive via email after completion and include it in your submission.

Electronic copies. Documents may be submitted via email, or via an email link to downloadable documents.



To minimize the use of non-recyclable materials ***please do not include vinyl or plastic binders, bindings, folders or covers with the filing.*** Staples and binder clips are good choices.

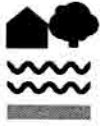

City of Boston
Environment



City of Boston
Mayor Martin J. Walsh

EXTENSION FORM

The undersigned hereby allows the Boston Conservation Commission an extension of time, beyond the statutory limit, to review an application or issue a final decision under the Massachusetts Wetlands Protection Act, M.G.L. Chapter 131, Section 40, and the Boston Wetlands Ordinance, Boston City Code, Ordinances, Chapter 7-1.4d during the state of emergency declared by the Governor on March 10, 2020.

Applicant:

Ryan

Woods

Boston Parks and Recreation

a. First Name

b. Last Name

c. Company

1010 Massachusetts Ave 3rd Floor

d. Mailing Address

Boston

MA

02118

e. City/Town

f. State

g. Zip Code

617-635-4505

parks@boston.gov

h. Phone Number

i. Fax Number

j. Email address

Signature of Applicant

2/2/2021

Date

Property Owner (if different):

a. First Name

b. Last Name

c. Company

d. Mailing Address

e. City/Town

f. State

g. Zip Code

h. Phone Number

i. Fax Number

j. Email address

Signature of Property Owner (if different)

Date

Applications will only be accepted when submitted with a properly executed Extension Form.

Boston – McConnell Park Improvements
WSE Project No. 2160850

February 3, 2021

Boston Conservation Commission
1 City Hall Square, Room 709
Boston, MA 02201-2031

**Re: NOI Filing
McConnell Park Improvements
Boston, MA**

Dear Members of the Commission:

On behalf of the Boston Parks and Recreation Department, Weston & Sampson Engineers, Inc. is hereby enclosing two (2) copies (including original) of the Notice of Intent submittal (including plans) to fulfill the requirements of the Massachusetts Wetlands Protection Act, M.G.L. Chapter 131, Section 40 submittal requirements and the City of Boston submittal requirements. This submittal is a formal Notice of Intent for the proposed improvements to McConnell Playground.

As part of the filing, we have attached the following:

- Appendix A: Project Description
- Appendix B: Stormwater Report
- Appendix C: Project Maps
- Appendix D: Contract Specifications
- Appendix E: Abutters List / Notice to Abutters
- Appendix F: Wetlands Memorandum
- Appendix G: Photos
- Appendix H: MEPA Certificate

If you have any questions regarding this submittal, please contact me at (978) 532-1900.

Very truly yours,

WESTON & SAMPSON



Alexandra Gaspar
Environmental Scientist



Enter your transmittal number

X286905
Transmittal Number

Your unique Transmittal Number can be accessed online:
<http://www.mass.gov/eea/agencies/massdep/service/approvals/transmittal-form-for-payment.html>

Massachusetts Department of Environmental Protection Transmittal Form for Permit Application and Payment

1. Please type or print. A separate Transmittal Form must be completed for each permit application.

2. Make your check payable to the Commonwealth of Massachusetts and mail it with a copy of this form to: MassDEP, P.O. Box 4062, Boston, MA 02211.

3. Three copies of this form will be needed.

Copy 1 - the original must accompany your permit application. **Copy 2** must accompany your fee payment. **Copy 3** should be retained for your records

4. Both fee-paying and exempt applicants must mail a copy of this transmittal form to:

MassDEP
P.O. Box 4062
Boston, MA
02211

* **Note:**
For BWSC Permits, enter the LSP.

A. Permit Information

WPA Form 3

Wetlands NOI

1. Permit Code: 4 to 7 character code from permit instructions

2. Name of Permit Category

Park/Playground Upgrades

3. Type of Project or Activity

B. Applicant Information – Firm or Individual

Boston Parks and Recreation Dept

1. Name of Firm - Or, if party needing this approval is an individual enter name below:

2. Last Name of Individual

3. First Name of Individual

4. MI

1010 Massachusetts Ave Floor 3

5. Street Address

Boston

MA

02118

617-635-4505

6. City/Town

7. State

8. Zip Code

9. Telephone #

10. Ext. #

Ryan Woods.

parks@boston.gov

11. Contact Person

12. e-mail address

C. Facility, Site or Individual Requiring Approval

McConnell Park

1. Name of Facility, Site Or Individual

Springdale Street

2. Street Address

Boston

MA

02125

3. City/Town

4. State

5. Zip Code

6. Telephone #

7. Ext. #

8. DEP Facility Number (if Known)

9. Federal I.D. Number (if Known)

10. BWSC Tracking # (if Known)

D. Application Prepared by (if different from Section B)*

Weston & Sampson Engineers

1. Name of Firm Or Individual

55 Walkers Brook Dr, Suite 100

2. Address

Reading

MA

01867

978-532-1900

3. City/Town

4. State

5. Zip Code

6. Telephone #

7. Ext. #

Alexandra Gaspar

8. Contact Person

9. LSP Number (BWSC Permits only)

E. Permit - Project Coordination

1. Is this project subject to MEPA review? yes no
If yes, enter the project's EOE file number - assigned when an Environmental Notification Form is submitted to the MEPA unit:

submitted concurrently
EOEA File Number

F. Amount Due

Special Provisions:

- Fee Exempt** (city, town or municipal housing authority)(state agency if fee is \$100 or less).
There are no fee exemptions for BWSC permits, regardless of applicant status.
- Hardship Request** - payment extensions according to 310 CMR 4.04(3)(c).
- Alternative Schedule Project** (according to 310 CMR 4.05 and 4.10).
- Homeowner** (according to 310 CMR 4.02).

DEP Use Only

Permit No:

Rec'd Date:

Reviewer:

Check Number

Dollar Amount

Date



Massachusetts Department of Environmental Protection
Bureau of Resource Protection - Wetlands

WPA Form 3 – Notice of Intent

Massachusetts Wetlands Protection Act M.G.L. c. 131, §40

Provided by MassDEP:

MassDEP File Number

Document Transaction Number

Boston

City/Town

Important:
When filling out forms on the computer, use only the tab key to move your cursor - do not use the return key.



Note:
Before completing this form consult your local Conservation Commission regarding any municipal bylaw or ordinance.

A. General Information

1. Project Location (**Note:** electronic filers will click on button to locate project site):

<u>Springdale Street</u>	<u>Boston</u>	<u>02125</u>
a. Street Address	b. City/Town	c. Zip Code
<u>Latitude and Longitude:</u>	<u>42deg18'31.457"N</u>	<u>71deg3'9.853"W</u>
	d. Latitude	e. Longitude
<u>1302238000</u>	<u>1302238000</u>	
f. Assessors Map/Plat Number	g. Parcel /Lot Number	

2. Applicant:

<u>Ryan</u>	<u>Woods</u>	
a. First Name	b. Last Name	
<u>Boston Parks and Recreation</u>		
c. Organization		
<u>1010 Massachusetts Avenue, Floor 3</u>		
d. Street Address		
<u>Boston</u>	<u>MA</u>	<u>02118</u>
e. City/Town	f. State	g. Zip Code
<u>617-635-4505</u>	<u>parks@boston.gov</u>	
h. Phone Number	i. Fax Number	j. Email Address

3. Property owner (required if different from applicant): Check if more than one owner

<u></u>	<u></u>	
a. First Name	b. Last Name	
<u></u>		
c. Organization		
<u></u>		
d. Street Address		
<u></u>	<u></u>	<u></u>
e. City/Town	f. State	g. Zip Code
<u></u>	<u></u>	<u></u>
h. Phone Number	i. Fax Number	j. Email address

4. Representative (if any):

<u>Alexandra</u>	<u>Gaspar</u>	
a. First Name	b. Last Name	
<u>Weston & Sampson Engineers</u>		
c. Company		
<u>55 Walkers Brook Drive, Suite 100</u>		
d. Street Address		
<u>Reading</u>	<u>MA</u>	<u>01867</u>
e. City/Town	f. State	g. Zip Code
<u>978-532-1900</u>	<u>gaspara@wseinc.com</u>	
h. Phone Number	i. Fax Number	j. Email address

5. Total WPA Fee Paid (from NOI Wetland Fee Transmittal Form):

<u>exempt</u>	<u></u>	<u></u>
a. Total Fee Paid	b. State Fee Paid	c. City/Town Fee Paid



Massachusetts Department of Environmental Protection
Bureau of Resource Protection - Wetlands

WPA Form 3 – Notice of Intent

Massachusetts Wetlands Protection Act M.G.L. c. 131, §40

Provided by MassDEP:

MassDEP File Number

Document Transaction Number

Boston

City/Town

A. General Information (continued)

6. General Project Description:

Playground Construction (See Appendix A for additional information)

7a. Project Type Checklist: (Limited Project Types see Section A. 7b.)

- 1. Single Family Home
- 2. Residential Subdivision
- 3. Commercial/Industrial
- 4. Dock/Pier
- 5. Utilities
- 6. Coastal engineering Structure
- 7. Agriculture (e.g., cranberries, forestry)
- 8. Transportation
- 9. Other

7b. Is any portion of the proposed activity eligible to be treated as a limited project (including Ecological Restoration Limited Project) subject to 310 CMR 10.24 (coastal) or 310 CMR 10.53 (inland)?

- 1. Yes No If yes, describe which limited project applies to this project. (See 310 CMR 10.24 and 10.53 for a complete list and description of limited project types)

2. Limited Project Type

If the proposed activity is eligible to be treated as an Ecological Restoration Limited Project (310 CMR10.24(8), 310 CMR 10.53(4)), complete and attach Appendix A: Ecological Restoration Limited Project Checklist and Signed Certification.

8. Property recorded at the Registry of Deeds for:

Suffolk

a. County

n/a

c. Book

b. Certificate # (if registered land)

n/a

d. Page Number

B. Buffer Zone & Resource Area Impacts (temporary & permanent)

- 1. Buffer Zone Only – Check if the project is located only in the Buffer Zone of a Bordering Vegetated Wetland, Inland Bank, or Coastal Resource Area.
- 2. Inland Resource Areas (see 310 CMR 10.54-10.58; if not applicable, go to Section B.3, Coastal Resource Areas).

Check all that apply below. Attach narrative and any supporting documentation describing how the project will meet all performance standards for each of the resource areas altered, including standards requiring consideration of alternative project design or location.



Massachusetts Department of Environmental Protection
Bureau of Resource Protection - Wetlands

WPA Form 3 – Notice of Intent

Massachusetts Wetlands Protection Act M.G.L. c. 131, §40

Provided by MassDEP:

MassDEP File Number

Document Transaction Number

Boston

City/Town

B. Buffer Zone & Resource Area Impacts (temporary & permanent) (cont'd)

For all projects affecting other Resource Areas, please attach a narrative explaining how the resource area was delineated.

Resource Area	Size of Proposed Alteration	Proposed Replacement (if any)
a. <input type="checkbox"/> Bank	1. linear feet	2. linear feet
b. <input type="checkbox"/> Bordering Vegetated Wetland	1. square feet	2. square feet
c. <input type="checkbox"/> Land Under Waterbodies and Waterways	1. square feet	2. square feet
	3. cubic yards dredged	

Resource Area	Size of Proposed Alteration	Proposed Replacement (if any)
d. <input type="checkbox"/> Bordering Land Subject to Flooding	1. square feet	2. square feet
	3. cubic feet of flood storage lost	4. cubic feet replaced
e. <input type="checkbox"/> Isolated Land Subject to Flooding	1. square feet	
	2. cubic feet of flood storage lost	3. cubic feet replaced
f. <input type="checkbox"/> Riverfront Area	1. Name of Waterway (if available) - specify coastal or inland	

2. Width of Riverfront Area (check one):

- 25 ft. - Designated Densely Developed Areas only
- 100 ft. - New agricultural projects only
- 200 ft. - All other projects

3. Total area of Riverfront Area on the site of the proposed project: _____ square feet

4. Proposed alteration of the Riverfront Area:

a. total square feet	b. square feet within 100 ft.	c. square feet between 100 ft. and 200 ft.
----------------------	-------------------------------	--

5. Has an alternatives analysis been done and is it attached to this NOI? Yes No

6. Was the lot where the activity is proposed created prior to August 1, 1996? Yes No

3. Coastal Resource Areas: (See 310 CMR 10.25-10.35)

Note: for coastal riverfront areas, please complete **Section B.2.f.** above.



Massachusetts Department of Environmental Protection
Bureau of Resource Protection - Wetlands

WPA Form 3 – Notice of Intent

Massachusetts Wetlands Protection Act M.G.L. c. 131, §40

Provided by MassDEP:

MassDEP File Number

Document Transaction Number

Boston

City/Town

B. Buffer Zone & Resource Area Impacts (temporary & permanent) (cont'd)

Check all that apply below. Attach narrative and supporting documentation describing how the project will meet all performance standards for each of the resource areas altered, including standards requiring consideration of alternative project design or location.

Online Users:
Include your document transaction number (provided on your receipt page) with all supplementary information you submit to the Department.

<u>Resource Area</u>	<u>Size of Proposed Alteration</u>	<u>Proposed Replacement (if any)</u>
a. <input type="checkbox"/> Designated Port Areas	Indicate size under Land Under the Ocean, below	
b. <input type="checkbox"/> Land Under the Ocean	_____	
	1. square feet	

	2. cubic yards dredged	
c. <input type="checkbox"/> Barrier Beach	Indicate size under Coastal Beaches and/or Coastal Dunes below	
d. <input type="checkbox"/> Coastal Beaches	_____	_____
	1. square feet	2. cubic yards beach nourishment
e. <input type="checkbox"/> Coastal Dunes	_____	_____
	1. square feet	2. cubic yards dune nourishment
	<u>Size of Proposed Alteration</u>	<u>Proposed Replacement (if any)</u>
f. <input type="checkbox"/> Coastal Banks	_____	
	1. linear feet	
g. <input type="checkbox"/> Rocky Intertidal Shores	_____	
	1. square feet	
h. <input type="checkbox"/> Salt Marshes	_____	_____
	1. square feet	2. sq ft restoration, rehab., creation
i. <input type="checkbox"/> Land Under Salt Ponds	_____	
	1. square feet	

	2. cubic yards dredged	
j. <input type="checkbox"/> Land Containing Shellfish	_____	
	1. square feet	
k. <input type="checkbox"/> Fish Runs	Indicate size under Coastal Banks, inland Bank, Land Under the Ocean, and/or inland Land Under Waterbodies and Waterways, above	

	1. cubic yards dredged	
l. <input checked="" type="checkbox"/> Land Subject to Coastal Storm Flowage	_____	
	265,778 sf	
	1. square feet	
4. <input type="checkbox"/> Restoration/Enhancement	If the project is for the purpose of restoring or enhancing a wetland resource area in addition to the square footage that has been entered in Section B.2.b or B.3.h above, please enter the additional amount here.	
	_____	_____
	a. square feet of BVW	b. square feet of Salt Marsh
5. <input type="checkbox"/> Project Involves Stream Crossings		
	_____	_____
	a. number of new stream crossings	b. number of replacement stream crossings



Massachusetts Department of Environmental Protection
Bureau of Resource Protection - Wetlands

WPA Form 3 – Notice of Intent

Massachusetts Wetlands Protection Act M.G.L. c. 131, §40

Provided by MassDEP:

MassDEP File Number

Document Transaction Number

Boston

City/Town

C. Other Applicable Standards and Requirements

- This is a proposal for an Ecological Restoration Limited Project. Skip Section C and complete Appendix A: Ecological Restoration Limited Project Checklists – Required Actions (310 CMR 10.11).

Streamlined Massachusetts Endangered Species Act/Wetlands Protection Act Review

1. Is any portion of the proposed project located in **Estimated Habitat of Rare Wildlife** as indicated on the most recent Estimated Habitat Map of State-Listed Rare Wetland Wildlife published by the Natural Heritage and Endangered Species Program (NHESP)? To view habitat maps, see the *Massachusetts Natural Heritage Atlas* or go to http://maps.massgis.state.ma.us/PRI_EST_HAB/viewer.htm.

- a. Yes No **If yes, include proof of mailing or hand delivery of NOI to:**

**Natural Heritage and Endangered Species Program
Division of Fisheries and Wildlife
1 Rabbit Hill Road
Westborough, MA 01581**

2020

b. Date of map

If yes, the project is also subject to Massachusetts Endangered Species Act (MESA) review (321 CMR 10.18). To qualify for a streamlined, 30-day, MESA/Wetlands Protection Act review, please complete Section C.1.c, and include requested materials with this Notice of Intent (NOI); *OR* complete Section C.2.f, if applicable. *If MESA supplemental information is not included with the NOI, by completing Section 1 of this form, the NHESP will require a separate MESA filing which may take up to 90 days to review (unless noted exceptions in Section 2 apply, see below).*

- c. Submit Supplemental Information for Endangered Species Review*

1. Percentage/acreage of property to be altered:
- (a) within wetland Resource Area _____ percentage/acreage
- (b) outside Resource Area _____ percentage/acreage
2. Assessor's Map or right-of-way plan of site
2. Project plans for entire project site, including wetland resource areas and areas outside of wetlands jurisdiction, showing existing and proposed conditions, existing and proposed tree/vegetation clearing line, and clearly demarcated limits of work **
- (a) Project description (including description of impacts outside of wetland resource area & buffer zone)
- (b) Photographs representative of the site

* Some projects **not** in Estimated Habitat may be located in Priority Habitat, and require NHESP review (see <http://www.mass.gov/eea/agencies/dfg/dfw/natural-heritage/regulatory-review/>). Priority Habitat includes habitat for state-listed plants and strictly upland species not protected by the Wetlands Protection Act.

** MESA projects may not be segmented (321 CMR 10.16). The applicant must disclose full development plans even if such plans are not required as part of the Notice of Intent process.

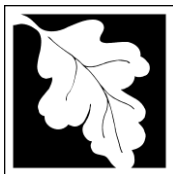

Massachusetts Department of Environmental Protection
Bureau of Resource Protection - Wetlands

WPA Form 3 – Notice of Intent

Massachusetts Wetlands Protection Act M.G.L. c. 131, §40

Provided by MassDEP:

MassDEP File Number

Document Transaction Number

Boston

City/Town

C. Other Applicable Standards and Requirements (cont'd)

- (c) MESA filing fee (fee information available at http://www.mass.gov/dfwele/dfw/nhesp/regulatory_review/mesa/mesa_fee_schedule.htm). Make check payable to “Commonwealth of Massachusetts - NHESP” and **mail to NHESP** at above address

Projects altering 10 or more acres of land, also submit:

- (d) Vegetation cover type map of site
- (e) Project plans showing Priority & Estimated Habitat boundaries
- (f) OR Check One of the Following
1. Project is exempt from MESA review.
Attach applicant letter indicating which MESA exemption applies. (See 321 CMR 10.14, http://www.mass.gov/dfwele/dfw/nhesp/regulatory_review/mesa/mesa_exemptions.htm; the NOI must still be sent to NHESP if the project is within estimated habitat pursuant to 310 CMR 10.37 and 10.59.)
 2. Separate MESA review ongoing. _____ a. NHESP Tracking # _____ b. Date submitted to NHESP
 3. Separate MESA review completed.
Include copy of NHESP “no Take” determination or valid Conservation & Management Permit with approved plan.
3. For coastal projects only, is any portion of the proposed project located below the mean high water line or in a fish run?
- a. Not applicable – project is in inland resource area only b. Yes No

If yes, include proof of mailing, hand delivery, or electronic delivery of NOI to either:

South Shore - Cohasset to Rhode Island border, and the Cape & Islands:

Division of Marine Fisheries -
Southeast Marine Fisheries Station
Attn: Environmental Reviewer
836 South Rodney French Blvd.
New Bedford, MA 02744
Email: DMF.EnvReview-South@state.ma.us

North Shore - Hull to New Hampshire border:

Division of Marine Fisheries -
North Shore Office
Attn: Environmental Reviewer
30 Emerson Avenue
Gloucester, MA 01930
Email: DMF.EnvReview-North@state.ma.us

Also if yes, the project may require a Chapter 91 license. For coastal towns in the Northeast Region, please contact MassDEP’s Boston Office. For coastal towns in the Southeast Region, please contact MassDEP’s Southeast Regional Office.



Massachusetts Department of Environmental Protection
Bureau of Resource Protection - Wetlands

WPA Form 3 – Notice of Intent

Massachusetts Wetlands Protection Act M.G.L. c. 131, §40

Provided by MassDEP:
MassDEP File Number
Document Transaction Number
Boston
City/Town

Online Users:
Include your document transaction number (provided on your receipt page) with all supplementary information you submit to the Department.

C. Other Applicable Standards and Requirements (cont'd)

4. Is any portion of the proposed project within an Area of Critical Environmental Concern (ACEC)?
 a. Yes No If yes, provide name of ACEC (see instructions to WPA Form 3 or MassDEP Website for ACEC locations). **Note:** electronic filers click on Website.
 b. ACEC
5. Is any portion of the proposed project within an area designated as an Outstanding Resource Water (ORW) as designated in the Massachusetts Surface Water Quality Standards, 314 CMR 4.00?
 a. Yes No
6. Is any portion of the site subject to a Wetlands Restriction Order under the Inland Wetlands Restriction Act (M.G.L. c. 131, § 40A) or the Coastal Wetlands Restriction Act (M.G.L. c. 130, § 105)?
 a. Yes No
7. Is this project subject to provisions of the MassDEP Stormwater Management Standards?
 a. Yes. Attach a copy of the Stormwater Report as required by the Stormwater Management Standards per 310 CMR 10.05(6)(k)-(q) and check if:
 1. Applying for Low Impact Development (LID) site design credits (as described in Stormwater Management Handbook Vol. 2, Chapter 3)
 2. A portion of the site constitutes redevelopment
 3. Proprietary BMPs are included in the Stormwater Management System.
 b. No. Check why the project is exempt:
 1. Single-family house
 2. Emergency road repair
 3. Small Residential Subdivision (less than or equal to 4 single-family houses or less than or equal to 4 units in multi-family housing project) with no discharge to Critical Areas.

D. Additional Information

- This is a proposal for an Ecological Restoration Limited Project. Skip Section D and complete Appendix A: Ecological Restoration Notice of Intent – Minimum Required Documents (310 CMR 10.12).

Applicants must include the following with this Notice of Intent (NOI). See instructions for details.

Online Users: Attach the document transaction number (provided on your receipt page) for any of the following information you submit to the Department.

1. USGS or other map of the area (along with a narrative description, if necessary) containing sufficient information for the Conservation Commission and the Department to locate the site. (Electronic filers may omit this item.)
2. Plans identifying the location of proposed activities (including activities proposed to serve as a Bordering Vegetated Wetland [BVW] replication area or other mitigating measure) relative to the boundaries of each affected resource area.



Massachusetts Department of Environmental Protection
Bureau of Resource Protection - Wetlands

WPA Form 3 – Notice of Intent

Massachusetts Wetlands Protection Act M.G.L. c. 131, §40

Provided by MassDEP:

MassDEP File Number

Document Transaction Number

Boston

City/Town

D. Additional Information (cont'd)

3. Identify the method for BVW and other resource area boundary delineations (MassDEP BVW Field Data Form(s), Determination of Applicability, Order of Resource Area Delineation, etc.), and attach documentation of the methodology.

4. List the titles and dates for all plans and other materials submitted with this NOI.

Improvements to McConnell Park

a. Plan Title

Weston & Sampson Engineers

Brandon Kunkel, PE

b. Prepared By

c. Signed and Stamped by

February 2021

as noted

d. Final Revision Date

e. Scale

f. Additional Plan or Document Title

g. Date

5. If there is more than one property owner, please attach a list of these property owners not listed on this form.

6. Attach proof of mailing for Natural Heritage and Endangered Species Program, if needed.

7. Attach proof of mailing for Massachusetts Division of Marine Fisheries, if needed.

8. Attach NOI Wetland Fee Transmittal Form

9. Attach Stormwater Report, if needed.

E. Fees

1. Fee Exempt: No filing fee shall be assessed for projects of any city, town, county, or district of the Commonwealth, federally recognized Indian tribe housing authority, municipal housing authority, or the Massachusetts Bay Transportation Authority.

Applicants must submit the following information (in addition to pages 1 and 2 of the NOI Wetland Fee Transmittal Form) to confirm fee payment:

2. Municipal Check Number

3. Check date

4. State Check Number

5. Check date

6. Payor name on check: First Name

7. Payor name on check: Last Name



Massachusetts Department of Environmental Protection
Bureau of Resource Protection - Wetlands

Provided by MassDEP:

WPA Form 3 – Notice of Intent

Massachusetts Wetlands Protection Act M.G.L. c. 131, §40

MassDEP File Number

Document Transaction Number



Boston

City/Town

F. Signatures and Submittal Requirements

I hereby certify under the penalties of perjury that the foregoing Notice of Intent and accompanying plans, documents, and supporting data are true and complete to the best of my knowledge. I understand that the Conservation Commission will place notification of this Notice in a local newspaper at the expense of the applicant in accordance with the wetlands regulations, 310 CMR 10.05(5)(a).

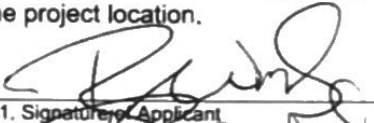
I further certify under penalties of perjury that all abutters were notified of this application, pursuant to the requirements of M.G.L. c. 131, § 40. Notice must be made by Certificate of Mailing or in writing by hand delivery or certified mail (return receipt requested) to all abutters within 100 feet of the property line of the project location.

<p>1. Signature of Applicant </p> <hr/> <p>3. Signature of Property Owner (if different) </p> <hr/> <p>5. Signature of Representative (if any) </p> <hr/>	<p>2. Date <u>2/4/2021</u></p> <hr/> <p>4. Date <u>2/4/2021</u></p> <hr/> <p>6. Date <u>2/5/2021</u></p> <hr/>
--	--

For Conservation Commission:

Two copies of the completed Notice of Intent (Form 3), including supporting plans and documents, two copies of the NOI Wetland Fee Transmittal Form, and the city/town fee payment, to the Conservation Commission by certified mail or hand delivery.

For MassDEP:

One copy of the completed Notice of Intent (Form 3), including supporting plans and documents, one copy of the NOI Wetland Fee Transmittal Form, and a copy of the state fee payment to the MassDEP Regional Office (see Instructions) by certified mail or hand delivery.

Other:

If the applicant has checked the "yes" box in any part of Section C, Item 3, above, refer to that section and the Instructions for additional submittal requirements.

The original and copies must be sent simultaneously. Failure by the applicant to send copies in a timely manner may result in dismissal of the Notice of Intent.

*  2/4/2021



Massachusetts Department of Environmental Protection
 Bureau of Resource Protection - Wetlands
NOI Wetland Fee Transmittal Form
 Massachusetts Wetlands Protection Act M.G.L. c. 131, §40

Important: When filling out forms on the computer, use only the tab key to move your cursor - do not use the return key.



A. Applicant Information

1. Location of Project:

Springdale Street Boston
 a. Street Address b. City/Town
 exempt
 c. Check number d. Fee amount

2. Applicant Mailing Address:

Ryan Woods
 a. First Name b. Last Name
 Boston Parks and Recreation
 c. Organization
 1010 Massachusetts Avenue, Floor 3
 d. Mailing Address
 Boston MA 02118
 e. City/Town f. State g. Zip Code
 617-6354505 parks@boston.gov
 h. Phone Number i. Fax Number j. Email Address

3. Property Owner (if different):

a. First Name b. Last Name
 c. Organization
 d. Mailing Address
 e. City/Town f. State g. Zip Code
 h. Phone Number i. Fax Number j. Email Address

B. Fees

Fee should be calculated using the following process & worksheet. **Please see Instructions before filling out worksheet.**

Step 1/Type of Activity: Describe each type of activity that will occur in wetland resource area and buffer zone.

Step 2/Number of Activities: Identify the number of each type of activity.

Step 3/Individual Activity Fee: Identify each activity fee from the six project categories listed in the instructions.

Step 4/Subtotal Activity Fee: Multiply the number of activities (identified in Step 2) times the fee per category (identified in Step 3) to reach a subtotal fee amount. Note: If any of these activities are in a Riverfront Area in addition to another Resource Area or the Buffer Zone, the fee per activity should be multiplied by 1.5 and then added to the subtotal amount.

Step 5/Total Project Fee: Determine the total project fee by adding the subtotal amounts from Step 4.

Step 6/Fee Payments: To calculate the state share of the fee, divide the total fee in half and subtract \$12.50. To calculate the city/town share of the fee, divide the total fee in half and add \$12.50.

To calculate filing fees, refer to the category fee list and examples in the instructions for filling out WPA Form 3 (Notice of Intent).



Massachusetts Department of Environmental Protection
 Bureau of Resource Protection - Wetlands
NOI Wetland Fee Transmittal Form
 Massachusetts Wetlands Protection Act M.G.L. c. 131, §40

B. Fees (continued)

Step 1/Type of Activity	Step 2/Number of Activities	Step 3/Individual Activity Fee	Step 4/Subtotal Activity Fee
exempt	exempt	exempt	exempt
_____	_____	_____	_____
_____	_____	_____	_____
_____	_____	_____	_____
_____	_____	_____	_____
_____	_____	_____	_____
_____	_____	_____	_____
_____	_____	_____	_____

Step 5/Total Project Fee: _____

Step 6/Fee Payments:

Total Project Fee:	<u>exempt</u>
	a. Total Fee from Step 5
State share of filing Fee:	<u>exempt</u>
	b. 1/2 Total Fee less \$12.50
City/Town share of filing Fee:	<u>exempt</u>
	c. 1/2 Total Fee plus \$12.50

C. Submittal Requirements

- a.) Complete pages 1 and 2 and send with a check or money order for the state share of the fee, payable to the Commonwealth of Massachusetts.

Department of Environmental Protection
 Box 4062
 Boston, MA 02211

- b.) **To the Conservation Commission:** Send the Notice of Intent or Abbreviated Notice of Intent; a **copy** of this form; and the city/town fee payment.

To MassDEP Regional Office (see Instructions): Send a copy of the Notice of Intent or Abbreviated Notice of Intent; a **copy** of this form; and a **copy** of the state fee payment. (E-filers of Notices of Intent may submit these electronically.)



INSTRUCTIONS FOR COMPLETING APPLICATION NOTICE OF INTENT – BOSTON NOI FORM

The Boston Notice of Intent Form is intended to be a supplement to the WPA Form 3 detailing impacts to locally designated wetland resource areas and buffer zones. Please read these instructions for assistance in completing the Notice of Intent application form. These instructions cover certain items on the Notice of Intent form that are not self-explanatory.

INSTRUCTIONS TO SECTION B: BUFFER ZONE AND RESOURCE AREA IMPACTS

Item 1. Buffer Zone Only. If you check the Buffer Zone Only box in this section you are indicating that the project is entirely in the Buffer Zone to a resource area **under both** the Wetlands Protection Act and Boston Wetlands Ordinance. If so, skip the remainder of Section B and go directly to Section C. Do not check this box if the project is within the Waterfront Area.

Item 2. The **boundaries of coastal resource areas** specific to the Ordinance can be found in Section II of the Boston Wetlands Regulations. You must also include the size of the proposed alterations (and proposed replacement areas) in each resource area.

Item 3. The **boundaries of inland resource areas** specific to the Ordinance can be found in Section II of the Boston Wetlands Regulations. You must also include the size of the proposed alterations (and proposed replacement areas) in each resource area.

INSTRUCTIONS TO SECTION C: OTHER APPLICABLE STANDARDS AND REQUIREMENTS

Item 1. Rare Wetland Wildlife Habitat. Except for Designated Port Areas, no work (including work in the Buffer Zone) may be permitted in any resource area that would have adverse effects on the habitat of rare, “state-listed” vertebrate or invertebrate animal species.

The most recent Estimated Habitat Map of State-Listed Rare Wetland Wildlife is published by the Natural Heritage and Endangered Species Program (NHESP). See: http://maps.massgis.state.ma.us/PRI_EST_HAB/viewer.htm or the *Massachusetts Natural Heritage Atlas*.

If any portion of the proposed project is located within Estimated Habitat, the applicant must send the Natural Heritage Program, at the following address, a copy of the Notice of Intent by certified mail or priority mail (or otherwise sent in a manner that guarantees delivery within two days), no later than the date of the filing of the Notice of Intent with the Conservation Commission.

Evidence of mailing to the Natural Heritage Program (such as Certified Mail Receipt or Certificate of Mailing for Priority Mail) must be submitted to the Conservation Commission along with the Notice of Intent.

Natural Heritage and Endangered Species Program
Division of Fisheries and Wildlife
1 Rabbit Hill Road
Westborough, MA 01581-3336
508.792.7270



5. Is any portion of the proposed project jurisdictional under the Massachusetts Wetlands Protection Act M.G.L. c. 131 §40?

- Yes No

If yes, please file the WPA Form 3 - Notice of Intent with this form

6. General Information

Park/Playground improvements at McConnell Park (See Appendix A
for additional information)

7. Project Type Checklist

- a. Single Family Home
- b. Residential Subdivision
- c. Limited Project Driveway Crossing
- d. Commercial/Industrial
- e. Dock/Pier
- f. Utilities
- g. Coastal Engineering Structure
- h. Agriculture – cranberries, forestry
- i. Transportation
- j. Other

8. Property recorded at the Registry of Deeds

Suffolk

a. County

not listed

b. Page Number

not listed

c. Book

d. Certificate # (if registered land)

9. Total Fee Paid

exempt

a. Total Fee Paid

exempt

b. State Fee Paid

exempt

c. City Fee Paid

B. BUFFER ZONE & RESOURCE AREA IMPACTS

Buffer Zone Only - Is the project located only in the Buffer Zone of a resource area protected by the Boston Wetlands Ordinance?

- Yes No

1. Coastal Resource Areas



<u>Resource Area</u>	<u>Resource Area Size</u>	<u>Proposed Alteration*</u>	<u>Proposed Mitigation</u>
<input type="checkbox"/> Coastal Flood Resilience Zone	_____ Square feet	_____ Square feet	_____ Square feet
<input type="checkbox"/> 25-foot Waterfront Area	10,600 _____ Square feet	10,600 _____ Square feet	10,600 _____ Square feet
<input type="checkbox"/> 100-foot Salt Marsh Area	_____ Square feet	_____ Square feet	_____ Square feet
<input type="checkbox"/> Riverfront Area	_____ Square feet	_____ Square feet	_____ Square feet

2. Inland Resource Areas

<u>Resource Area</u>	<u>Resource Area Size</u>	<u>Proposed Alteration*</u>	<u>Proposed Mitigation</u>
<input type="checkbox"/> Inland Flood Resilience Zone	_____ Square feet	_____ Square feet	_____ Square feet
<input type="checkbox"/> Isolated Wetlands	_____ Square feet	_____ Square feet	_____ Square feet
<input type="checkbox"/> Vernal Pool	_____ Square feet	_____ Square feet	_____ Square feet
<input type="checkbox"/> Vernal Pool Habitat (vernal pool + 100 ft. upland area)	_____ Square feet	_____ Square feet	_____ Square feet
<input type="checkbox"/> 25-foot Waterfront Area	_____ Square feet	_____ Square feet	_____ Square feet
<input type="checkbox"/> Riverfront Area	_____ Square feet	_____ Square feet	_____ Square feet

C. OTHER APPLICABLE STANDARDS & REQUIREMENTS

1. What other permits, variances, or approvals are required for the proposed activity described herein and what is the status of such permits, variances, or approvals?

MEPA ENF - Received certificate 2/1/2021

Chapter 91 Waterways Application - submitted concurrently



2. Is any portion of the proposed project located in Estimated Habitat of Rare Wildlife as indicated on the most recent Estimated Habitat Map of State-Listed Rare Wetland Wildlife published by the Natural Heritage and Endangered Species Program (NHESP)? To view habitat maps, see the Massachusetts Natural Heritage Atlas or go to <http://www.mass.gov/dfwele/dfw/nhosp/nhregmap.htm>.

- Yes No

If yes, the project is subject to Massachusetts Endangered Species Act (MESA) review (321 CMR 10.18).

A. Submit Supplemental Information for Endangered Species Review

Percentage/acreage of property to be altered:

(1) within wetland Resource Area _____ percentage/acreage

(2) outside Resource Area _____ percentage/acreage

Assessor's Map or right-of-way plan of site

3. Is any portion of the proposed project within an Area of Critical Environmental Concern?

- Yes No

If yes, provide the name of the ACEC: _____

4. Is the proposed project subject to provisions of the Massachusetts Stormwater Management Standards?

- Yes. Attach a copy of the Stormwater Checklist & Stormwater Report as required.
 - Applying for a Low Impact Development (LID) site design credits
 - A portion of the site constitutes redevelopment
 - Proprietary BMPs are included in the Stormwater Management System
- No. Check below & include a narrative as to why the project is exempt
 - Single-family house
 - Emergency road repair
 - Small Residential Subdivision (less than or equal to 4 single family houses or less than or equal to 4 units in a multifamily housing projects) with no discharge to Critical Areas

5. Is the proposed project subject to Boston Water and Sewer Commission Review?

- Yes No



D. SIGNATURES AND SUBMITTAL REQUIREMENTS

I hereby certify under the penalties of perjury that the foregoing Notice of Intent and accompanying plans, documents, and supporting data are true and complete to the best of my knowledge. I understand that the Conservation Commission will place notification of this Notice in a local newspaper at the expense of the applicant in accordance with the Wetlands Protection Ordinance.

[Handwritten Signature]

Signature of Applicant

2/4/2021

Date

[Handwritten Signature]

Signature of Property Owner (if different)

2/4/2021

Date

[Handwritten Signature]

Signature of Representative (if any)

2/5/2021

Date

** [Handwritten Signature]*

2/4/2021

Record Encumbrances

1. Eminent Domain Taking by the City of Boston dated September 18, 1899 and recorded at Book 2645, Page 30.
2. Eminent Domain Taking by the City of Boston dated January 27, 1914 and recorded at Book 3785, Page 334.
3. Taking (with accompanying plan) by the Commonwealth of Massachusetts Department of Public Works for the layout and establishment of a portion of the Southeast Expressway as a state highway, dated June 14, 1955 and recorded in Book 7067, Page 244.
4. Taking (with accompanying plan) by the Commonwealth of Massachusetts Department of Public Works for the layout and establishment of a portion of the Southeast Expressway as a state highway, dated January 24, 1956 and recorded in Book 7128, Page 184.
5. Taking (with accompanying plan) by the Commonwealth of Massachusetts Department of Public Works for the layout and establishment of a portion of the Southeast Expressway as a state highway, dated February 28, 1956 and recorded in Book 7136, Page 438.
6. Plan accompanying Taking at Book 7128, Page 184 shows a way or sewer easement extending from state highway into McConnell Park.
7. Matters disclosed on plan dated January 17, 1962 and recorded with Eminent Domain Taking by the Commonwealth of Massachusetts Metropolitan District Commission dated January 18, 1962 and recorded at Book 7624, Page 579:
 - a. Reinforced concrete conduit
 - b. Drainage lines
 - c. Conduit
 - d. Water pipe
8. City of Boston Public Works Department Order of Intention to Construct Concrete Overflow dated October 17, 1929 and recorded at Book 5142, Page 627.
9. Matters disclosed on Feldman plan.

us from all right and interest in the granted premises, whether at law or in equity. And we do hereby for ourselves our heirs and assigns further covenant and agree with the grantee its successors and assigns that on such sale we and they will upon request execute and deliver such further deeds and instruments as may be necessary or proper to confirm such sale, and to vest the title to the premises sold in the purchaser thereof, and will execute and deliver to the purchaser an assignment of all policies of insurance on the buildings upon the land covered by this mortgage. And out of the money arising from such sale the grantee or its successors or assigns shall be entitled to retain all moneys then secured by this deed whether or then or thereafter payable, including all costs charges and expenses incurred or sustained by reason of any failure or default on the part of us or of our representatives to perform and fulfil the conditions of this deed, rendering the surplus if any to us or our heirs or assigns. And it is agreed that the grantee or its successors or assigns or any person or persons in their behalf, may purchase at any sale made as aforesaid, and that no other purchaser shall be answerable for the application of the purchase money: and that until default in the performance of the condition of this deed we and our heirs and assigns may hold and enjoy the granted premises and receive the rents and profits thereof. In witness whereof in the said County of Suffolk and City of Boston we the said Henry B. Thayer and Florence A. Thayer hereunto set our hands and seals this third day of November in the year one thousand eight hundred and ninety-nine. Henry B. Thayer and a seal. Florence A. Thayer and a seal. Signed sealed and delivered in presence of Walter H. Roberts to both Counties of Massachusetts Suffolk on November 10th 1899. Then personally appeared the above named Henry B. Thayer and Florence A. Thayer and acknowledged the foregoing instrument to be their free act and deed before me Walter H. Roberts Justice of the Peace _____ November 10, 1899, at New Bedford, Massachusetts. F. M. Keenan, Clerks and Commis. *Wm. Thayer*

Witnesses
 heirs or assigns
 City of Boston

City of Boston _____ In Board of Park Commissioners.
 September 18, 1899 _____ The Board of Park Commissioners
 of the City of Boston by virtue and in strict execution of

the authority given to it by chapter 412 of the Acts of the year eighteen hundred and ninety-eight, and chapter 279 of the Acts of the year eighteen hundred and ninety-nine, does hereby take for a play-ground the following described parcel of land situate in that part of Boston formerly called Dorchester, namely: a parcel of land supposed to belong to the heirs or devisees of William Worthington, bounded and described as follows: Beginning at the intersection of the Southwesterly line of Springdale Street, so-called, & the location of the Old Colony Railroad, and running Southeasterly on said Springdale Street 490 ⁴⁷/₁₀₀ feet and 214 ⁴⁴/₁₀₀ feet to land of Phoebe M. Bassil, thence running Southwesterly on said land of Bassil, 80 feet: thence running Eastward and Southeasterly on said land of Bassil and on land of William Bryan 70 feet and 80 ⁶⁰/₁₀₀ feet to road Springdale Street: thence running Easterly on said Springdale Street 125 ⁶³/₁₀₀ feet to other land of the heirs or devisees of William Worthington: thence running Southwesterly on said other land of the heirs or devisees of William Worthington, by a line drawn through a post in the Harbor Commissioners line distant 173 ³⁶/₁₀₀ feet Southeasterly from the angle in said Harbor Commissioners line, to the line of extreme low water: thence running Southwesterly on said low water line to land of the Dorchester Gas Light Company: thence running Northwesterly on said land of the Dorchester Gas Light Company to the location of said Old Colony Railroad: thence running Northeasterly on said railroad location 1, 237 ¹²/₁₀₀ feet to the point of beginning: containing 809,200 square feet, more or less: together with all the right, title and interest of said heirs or devisees of William Worthington as to said Springdale Street. Said parcel of land hereinafter on a piece of Green Hill Playground, dated August 1899, registered by S. to Putnam Art Engineer, and on file in the office of this Board. Charles E. Stratton Debrah Pratt, for M. Prudergast, The Board of Park Commissioners of the City of Boston. Approved: Josiah Quincy Mayor.

November 11, 1899, at one o'clock and forty four minutes P.M. Received - Entered & Examined *W.H. [Signature]*

City of Boston
November 14, 1899
The Board of Park Commissioners of the

While est to City of Boston

charges and expenses incurred or sustained by them by reason of any default in the performance or observance of the said condition, rendering the surplus, if any, to me or my heirs or assigns; and I hereby for myself and my heirs or assigns, covenant with the grantee and her heirs, executors, administrators, and assigns, that, in case a sale shall be made under the foregoing power, I or they will, upon request, execute, acknowledge, and deliver to the purchaser or purchasers a deed or deeds of release confirming such sale, and that the benefit of any entry shall enure to any purchaser at said sale who shall be held to claim thereunder in case of any defect in said sale, and said grantee and her assigns are hereby appointed and constituted the attorney or attorneys irrevocable of the said grantor and his successors in the title to the granted premises to execute and deliver to the said purchaser a full transfer of all policies of insurance on the buildings upon the land covered by this mortgage at the time of such sale, and acceptance of a deed of the granted premises by any successors in title to the grantor while this mortgage shall be outstanding shall be a sufficient ratification of this appointment. AND IT IS AGREED that the grantee, or her executors, administrators, or assigns, or any person or persons in their behalf, may purchase at any sale made as aforesaid, and that no other purchaser shall be answerable for the application of the purchase money; and that until default in the performance or observance of the condition of this deed, I and my heirs and assigns may hold and enjoy the granted premises and receive the rents and profits thereof. IN WITNESS WHEREOF I the said Moses S. Benrimo hereunto set my hand and seal this twenty-eighth day of January in the year one thousand nine hundred and fourteen. Moses S. Benrimo and two seals. Signed and sealed in presence of - COMMONWEALTH OF MASSACHUSETTS. Suffolk co. Boston, Jan. 28, 1914. Then personally appeared the above-named Moses S. Benrimo and acknowledged the foregoing instrument to be his free act and deed, before me, Julius Nelson, Justice of the Peace. ----- January 28, 1914 at four o'clock and six minutes P.M. Received, Entered and Examined.

----- 3785-334

In Board of Street Commissioners of the City of Boston.
January 28, 1914. - Whereas, acting under the provisions of chapter

RECEIVED
at al Est.
No
of

or the City of Boston has requested the Board of Street Commissioners of said city to take the parcels of land hereinafter described, situate in that part of Boston formerly Dorchester, for playground purposes. Voted: That the Board of Street Commissioners of said city of Boston hereby takes under the right of eminent domain, in fee for said city for playground purposes the said parcels of land bounded and described as follows: A parcel of land supposed to belong to Phoebe M. Bassill, bounded - Northeast by Denny Street, by two measurements, sixty-three and $44/100$ feet on a curve of of two hundred seventy-seven and $40/100$ feet radius, and five and $56/100$ feet south by land hereafter described as taken from heirs of William Bryan, eighty-two feet; southwest by land of the City of Boston, forty-two feet; and northwest by the same, eighty feet; containing forty-five hundred square feet, more or less. A parcel of land supposed to belong to heirs of William Bryan, bounded - Northeast by Denny street, twenty-six feet; south by land of the City of Boston, eighty and $60/100$ feet; southwest by the same, twenty-eight feet; and north by land before described as taken from Phoebe M. Bassill, eighty-two feet; containing twenty-one hundred ninety-seven square feet, more or less. A parcel of land supposed to belong to Thomas J. Sheehan, bounded - Southwest by Denny street, eighty-five and $74/100$ feet; northeast by land hereafter described as taken from Peter F. and John J. Lamont, sixty-one and $67/100$ feet; east by the same, sixty-one and $67/100$ feet; and south by land hereafter described as taken from Martha L. Richardson et al, forty-one and $83/100$ feet: containing thirty-four hundred thirty-four square feet more or less. A parcel of land supposed to belong to Peter F. and John J. Lamont, bounded - Southwest by Denny street, sixteen and $84/100$ feet; northwest by the same, ninety and $77/100$ feet on a curve of one hundred five and $75/100$ feet radius; northeast by land supposed to belong to Peter F. and John J. Lamont, to person or persons unknown (Bayside street) and to Peter F. and John J. Lamont two hundred seventy-one and $11/100$ feet; southeast by land hereafter described as taken from James Lyons, eighty-three and $78/100$ feet; south by land hereafter described as taken from Martha L. Richardson et al, by two measurements, one hundred nine and $85/100$ feet and sixty-one and $80/100$ feet; west by land before described as taken from Thomas J. Sheehan, sixty-one and $67/100$ feet; and southeast by

before described as taken from Peter F. and John J. Lamont, eighty-three and $76/100$ feet; northeast by other land of said Lyons, one hundred feet; north by the same, two hundred forty-seven and $12/100$ feet; southeast by land hereafter described as taken from Martha L. Richardson et al, sixty and $94/100$ feet; and south by the same, three hundred eighteen and $2/100$ feet: containing eleven thousand nine hundred eighty-seven square feet, more or less. A parcel of land supposed to belong to Martha L. Richardson $\frac{1}{2}$, Stanley W. Richardson $\frac{1}{4}$, Rachel H. Roberts $\frac{1}{4}$, bounded - North by Denny street, by land before described as taken from Thomas J. Sheehan, from Peter F. and John J. Lamont, and from James Lyons, by two measurements, one hundred thirty-nine and $95/100$ feet and four hundred twenty-seven and $57/100$ feet; northwest by land before described as taken from James Lyons, sixty and $94/100$ feet; southeast by other land of said Martha L. Richardson et al, thirty-five feet; south by land hereafter described as taken from said Martha L. Richardson et al (flats) six hundred fifty-six feet; and northwest by land of the city of Boston, fifty-two feet; containing twelve thousand square feet, more or less. A parcel of land supposed to belong to Martha L. Richardson $\frac{1}{2}$, Stanley W. Richardson $\frac{1}{4}$, Rachel H. Roberts $\frac{1}{4}$, bounded - North by land before described as taken from said Martha L. Richardson et al, six hundred fifty-six feet; southeast by other land of said Martha L. Richardson et al, (flats) five hundred forty-three feet; southwest by land (flats) hereafter described as taken from said Martha L. Richardson et al, six hundred five feet; and northwest by land of the City of Boston (flats) three hundred seventy-four and $79/100$ feet: containing two hundred seventy-five thousand square feet, more or less. Said parcel as described is flats between approximate mean high water and harbor line. A parcel of land supposed to belong to Martha L. Richardson $\frac{1}{2}$, Stanley W. Richardson $\frac{1}{4}$, Rachel H. Roberts $\frac{1}{4}$, bounded - Northeast by land of the City of Boston (flats) and by land before described (flats) as taken from said Martha L. Richardson et al, seven hundred seventy-eight and $18/100$ feet; southeast by other land (flats) of said Martha L. Richardson et al, six hundred forty-five feet; southwest by approximate mean low water line, nine hundred twenty feet; and northwest by land (flats) of the city of Boston, two hundred

... and approximate mean low water line. Said parcels are shown on a plan marked "City of Boston Savin Hill Playground Berchester January 18, 1914 F.O. Whitney Chief Engineer Street Laying-Out Dept." and on file in the office of said department. Salem D. Charles James A. Callivan, John H. Dunn, Board of Street Commissioners of the City of Boston. - APPROVED JAN 27 1914 John F Fitzgerald, Mayor of Boston, Mass. ----- January 26, 1914 at four o'clock and twenty-nine minutes P.M. Received, Entered and Examined. -----

In Board of Street Commissioners of the City of Boston,
January 26, 1914. WHEREAS, acting under the provisions of chapter 486 of the Acts of the Legislature of 1909, and all other authority thereto enabling, the Department of Public Buildings of the City of Boston has requested the Board of Street Commissioners of said city to take for the purpose of erecting a municipal building thereon a certain parcel of land situated in that part of Boston formerly Dorchester, Voted: That the Board of Street Commissioners of said city of Boston hereby takes, under the right of eminent domain, in fee for said city for the purpose of erecting a municipal building thereon the following described parcel of land. A parcel of land supposed to belong to Benjamin F. McKechnie, bounded - Southwest by Morton street, sixty-four and 21/100 feet; northwest by land of the city of Boston, one hundred twenty-eight and 83/100 feet; and southeast by other land of said McKechnie, one hundred ten and 63/100 feet: containing thirty-five hundred fifty-one square feet, more or less. The said parcel of land is shown on a plan marked "City of Boston Morton St. Dorchester Dec. 6, 1913 F.O. Whitney Chief Engineer Street Laying-Out Dept." and on file in the office of said department Salem D. Charles, James A. Callivan, John H. Dunn, Street Commissioners. - APPROVED JAN 27 1914. John F Fitzgerald, Mayor of Boston, Mass. ----- January 26, 1914 at four o'clock and twenty-nine minutes P.M. Received, Entered and Examined. -----

McKECHNIE
Est.
to
CITY OF BOSTON

THIS INDENTURE, made this seventeenth day of January A.D. 1914 between Florence H. Goodsell the holder and owner of a certain mortgage given by Edward J. Featherston and Frederick S. Whipp to said Goodsell dated September 27, A.D. 1910, and recorded in Suffolk Registry of Deeds, librs 2422 folio 306, of the first part, and said

GOODSELL
and
FEATHERSTON
et al

Appendix A

PROJECT DESCRIPTION

Background

McConnell Park currently suffers from public safety concerns related to unenforced parking restrictions and emergency access through Springdale Street as well as flood and stormwater inundation during severe storm events and king tides. This project will provide a designated emergency access route to connect Playstead Road and Denny Street via Springdale Street, an orderly striped parking lot with enforcement signage, and will increase site elevations to alleviate current flood pathways that threaten the northerly residential area. The entirety of proposed park upgrades will provide a more resilient open space amenity to serve residents for decades to come.

Site Description

The McConnell Park (~6 acres) parcel is located on Springdale Street in the Dorchester neighborhood of Boston, south of Playstead Road and Denny Street. The property is bordered to the west by I-93, to the south and east by Massachusetts Department of Conservation and Recreation (DCR) owned harborwalk and the Dorchester Bay, and to the north by Springdale Street and a residential neighborhood. Springdale Street is a “paper street” and is a private way. The existing park property consists of three natural turf softball fields on the western portion of the site, an impervious parking area and unofficial emergency access drive near the center of the site, and a lawn area with mature tree canopy to the east. The park is bisected by an impervious access drive which serves the adjacent Dorchester Yacht Club. The park also includes a children’s playground with pervious mulch fiber surfacing near the harborwalk on the southern edge of the parcel. DCR’s signature is included in this submittal only to show they are aware of and approve of the proposed changes.

Scope of Work

This project consists of reconstructing the ball fields to include fully lit natural turf Little League and Softball fields, an accessible synthetic turf challenger league diamond, an expanded and upgraded inclusive playground, an improved parking lot with designated emergency drive, a pedestrian plaza with traffic calming devices, and improved tree canopy to increase shade. Additional site improvements include street lighting and security cameras, paved walkways, spectator seating areas, portable restroom shelter, site furnishings, and planting areas.

This project will also include significant improvements to on-site storm water management. As currently designed, storm water will be captured by deep sump hooded catch basins or curb inlets and treated by planted basins and conveyed to underground storage chambers to minimize peak flows off-site. A number of check valves will be installed at downstream drain pipe locations to mitigate upwelling during severe storm events. Stormwater recharge is not recommended on-site due to the soil classification and state regulations which discourage the practice of infiltration into material containing urban debris. This improved system will alleviate stormwater and floodwater threats on-site and will treat and hold water before directing to the nearby outfall at Morrissey Boulevard.

Environmental Considerations

Sensitive environmental resource areas in, or near, the work area include Coastal Bank, 25-foot Waterfront Area and Land Subject to Coastal Storm Flowage. No work is proposed within the mean high-water limit.

Work will impact approximately 265,800 square feet of Land Subject to Coastal Storm Flowage, 10,600 square feet of 25-foot Waterfront Area, and 68,800 square feet of the 100' Coastal Buffer. This work will occur within previously altered area (the park and playground) and will include construction of new ballfields, playground, paved walkways and parking lot, and new planted areas. Because the first inch of stormwater runoff is being collected from all impervious surfaces and treated, negative environmental impacts to the Land Subject to Coastal Storm Flowage resource area are not anticipated.

The length of Coastal Bank that abuts the park property is 1,020 linear feet and will not be impacted as part of the park improvements.

To protect the resource areas outside the work area (Coastal Bank) during construction, compost tubes and catch basin sediment protection measures will be placed around the perimeter of the work area at the interface with resource areas. The erosion controls will be monitored throughout the project and accumulated sediment will be removed.

Climate Resiliency

The proposed improvements include several considerations for potential effects of projected climate change scenarios. In regard to sea level rise, areas of the site are proposed to be elevated to act as a barrier and enclose key flood pathways that exist on site today. The proposed parking lot layout and elevations will raise the new parking lot, Springdale Street and multiuse plaza up to 5 feet, utilizing lightweight fill material and stabilized with geogrid, to achieve elevations of 17.00 ft to 19.60 ft BCB. This elevation change is intended to increase the resiliency of the parking lot, Springdale Street, and residential abutters. The intent of the project is to transition from existing elevations for the parking lot and access drive up to and above elevation 18.00 ft BCB which is the expected base flood elevation in 2050 for the 100-year storm, while considering existing topographical and private property limitations of surrounding abutters and accessibility requirements. All other areas of the park and the proposed amenities below elevation 18.00 ft BCB are being topographically graded to ensure improved stormwater collection, drainage, and flood recovery time. The proposed contouring and topography throughout the park will range from 0 to 1-foot of fill throughout the athletic fields and transition back to existing grades at the eastern limits of the park. As noted, the project will improve peak discharge rates for stormwater for the 2-year, 10-year, 25-year, and 100-year storms as compared to existing condition.

In consideration of stormwater flooding changes with anticipated storm intensity and frequency, the stormwater design proposal reduces peak flow during several storm events, provides subsurface chambers to store and infiltrate excess stormwater, and adds check-valves to mitigate the risk of upwelling from downstream structures during such scenarios. More specifically, the proposed stormwater design provides for 60% peak discharge reduction for the 2-year storm, 35% reduction for the 10-year storm, 28% reduction for the

25-year, and 20% reduction at the 100-year storm event downstream. Additionally, Low Impact Development (LID) techniques are utilized throughout the park design and include minimizing disturbance to existing trees and shrubs and introducing bioretention basins where feasible with existing soil conditions. The proposed subsurface infiltration chambers located adjacent to the access drive and parking lot will hold stormwater on-site to further reduce the downstream and offsite pressures at the existing outlet culvert that runs parallel to the DCR Harborwalk and services much of the Savin Hill neighborhood.

The proposed finish materials and planting also consider projected climate change scenarios in relation to heat island effect and increased peak air temperatures as they impact visitor comfort. Numerous shade trees will be planted throughout the site and will offer more shade than present conditions, especially over time as the trees mature. Furthermore, low-albedo pavement finishes, and grass and shrub plantings have been selected in areas where park visitors are expected to gather contributing to a cooler microclimate with the tree increased canopy. The proposed planting palette adapts to the increased risk in severe coastal storms by minimizing the effects of erosion and dampening wave action while also tolerating saltwater in the face of inundation.

Land Subject to Coastal Storm Flowage (LSCSF)

There are no performance standards for Land Subject to Coastal Storm Flowage in the WPA regulations however, the Massachusetts Department of Environmental Protection (MassDEP) and the Massachusetts Office of Coastal Zone Management (CZM) have created the Coastal Manual which provides technical guidance on the coastal resource areas identified in the WPA. The Coastal Manual identifies the importance of Land Subject to Coastal Storm Flowage relative to the interests of storm damage prevention and flood control and sets forth three presumptions for Conservation Commissions to Consider when reviewing projects that occur in this resource area. These three presumptions set forth in the Coastal Manual (Page 2-39) have been taken into consideration and are addressed here;

- 1. Presume that land subject to coastal storm flowage performs functions for the storm damage prevention and flood control interests**

The Limit of Work consists of already developed area (playground and park). As stated above, this project will increase site elevations and upgrade the stormwater management system to alleviate current flood pathways that threaten the northerly residential area.

- 2. Consider whether the project adversely impacts these functions and interests**

As noted above, the proposed project intends to enhance the current stormwater management system on site and remove some of the land out of the floodzone.

- 3. Impose conditions to contribute to the protection of these interests.**

Proper sediment and erosion control measures will be utilized on site to protect surrounding resource areas (Dorchester Bay).

The Coastal Manual also recommends that:

“Commissions should consider the impacts of the proposed project on the landform and whether the project increases the elevation or velocity of flood waters or increases flow due to a change in direction or flow characteristics (e.g., change in direction) on the subject site, adjacent properties, or any public or private way”

As noted above, this project will increase site elevations to alleviate current flood pathways that threaten the northerly residential area. The project will ultimately result in improved floodwater characteristics. See Appendix B for a complete stormwater report.

25' Waterfront Area

This project will have approximately 10,600 square feet of impact to the 25' Waterfront Area, a resource protected by the Boston Conservation Commission Wetland Regulations. The Boston Wetland Ordinance states the following regarding buffer zones:

The Buffer Zone is presumed important to the protection of the resource areas because activities undertaken in close proximity to resource areas have a reasonable probability of adverse impact upon the wetland or other resource, either immediately, as a consequence of construction, or over time, as a consequence of daily operation or existence of the activities. These adverse impacts from construction and use can include, without limitation, erosion, siltation, loss of groundwater recharge, degraded water quality, loss of wildlife habitat, degradation of wetland plant habitat, alteration of hydrology, soil contamination, and proliferation of invasive plants.

While the 25' Waterfront Area is in close proximity to coastal bank, it is considered already altered area that consists of manicured lawn, concrete, and bituminous pavement. Work in this area includes installation of concrete paving for portable restroom and field access, manicured lawn, wood guardrail, bituminous concrete at pavement walkways and driveways, vertical granite curb at Dorchester Yacht Club access drive, concrete pavement repairs and bollard relocation at the Harborwalk, and erosion control planting mix at sloped tree bed areas.

Work will also include demolition of existing bituminous and concrete pavement walks and driveways, removal of existing wood guardrail, stripping and stockpiling of topsoil, installation of tree protection for trees to remain, patching and clearing of sloped tree beds, and installation of all items mentioned above.

To avoid erosion and siltation, proper erosion control will be utilized for the duration of the project to protect the waterfront area. No degradation of wetland plant habitat or loss of wildlife habitat is anticipated because as stated above the 25' Waterfront Area is considered already an altered area. Proper tree protection will be applied to protect the trees to remain.

Appendix B

Stormwater Report

Conservation Commission
Boston, Massachusetts

McConnell Park

October 21, 2020

JOB NO: 2160850

Weston & SampsonSM

Weston & Sampson
55 Walkers Brook Drive
Reading, MA 01867

www.westonandsampson.com
Tel: 978-532-1900 Fax: 978-977-0100

Table of Contents

Checklist for Stormwater Report

Stormwater Report Summary

Attachment A - Locus Map

Attachment B - NRCS Soils Map, Soils Report, and HSG Classifications

Attachment C - Test Pit Summary and Logs

Attachment D - HydroCAD Reports

Attachment E - Calculations

1. Required Recharge Calculation
2. Water Quality Volume Calculation
3. Isolator Row Sizing
4. TSS Removal Worksheets

Attachment F - Long Term Pollution Prevention Plan

Attachment G - Construction Period Pollution and Erosion and Sedimentation Control Plan

Attachment H - Operations and Maintenance Plan

Attachment I - Illicit Discharge Compliance Statement



Checklist for Stormwater Report

A. Introduction

Important: When filling out forms on the computer, use only the tab key to move your cursor - do not use the return key.

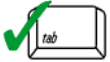

A Stormwater Report must be submitted with the Notice of Intent permit application to document compliance with the Stormwater Management Standards. The following checklist is NOT a substitute for the Stormwater Report (which should provide more substantive and detailed information) but is offered here as a tool to help the applicant organize their Stormwater Management documentation for their Report and for the reviewer to assess this information in a consistent format. As noted in the Checklist, the Stormwater Report must contain the engineering computations and supporting information set forth in Volume 3 of the [Massachusetts Stormwater Handbook](#). The Stormwater Report must be prepared and certified by a Registered Professional Engineer (RPE) licensed in the Commonwealth.

The Stormwater Report must include:

- The Stormwater Checklist completed and stamped by a Registered Professional Engineer (see page 2) that certifies that the Stormwater Report contains all required submittals.¹ This Checklist is to be used as the cover for the completed Stormwater Report.
- Applicant/Project Name
- Project Address
- Name of Firm and Registered Professional Engineer that prepared the Report
- Long-Term Pollution Prevention Plan required by Standards 4-6
- Construction Period Pollution Prevention and Erosion and Sedimentation Control Plan required by Standard 8²
- Operation and Maintenance Plan required by Standard 9

In addition to all plans and supporting information, the Stormwater Report must include a brief narrative describing stormwater management practices, including environmentally sensitive site design and LID techniques, along with a diagram depicting runoff through the proposed BMP treatment train. Plans are required to show existing and proposed conditions, identify all wetland resource areas, NRCS soil types, critical areas, Land Uses with Higher Potential Pollutant Loads (LUHPPL), and any areas on the site where infiltration rate is greater than 2.4 inches per hour. The Plans shall identify the drainage areas for both existing and proposed conditions at a scale that enables verification of supporting calculations.

As noted in the Checklist, the Stormwater Management Report shall document compliance with each of the Stormwater Management Standards as provided in the Massachusetts Stormwater Handbook. The soils evaluation and calculations shall be done using the methodologies set forth in Volume 3 of the Massachusetts Stormwater Handbook.

To ensure that the Stormwater Report is complete, applicants are required to fill in the Stormwater Report Checklist by checking the box to indicate that the specified information has been included in the Stormwater Report. If any of the information specified in the checklist has not been submitted, the applicant must provide an explanation. The completed Stormwater Report Checklist and Certification must be submitted with the Stormwater Report.

¹ The Stormwater Report may also include the Illicit Discharge Compliance Statement required by Standard 10. If not included in the Stormwater Report, the Illicit Discharge Compliance Statement must be submitted prior to the discharge of stormwater runoff to the post-construction best management practices.

² For some complex projects, it may not be possible to include the Construction Period Erosion and Sedimentation Control Plan in the Stormwater Report. In that event, the issuing authority has the discretion to issue an Order of Conditions that approves the project and includes a condition requiring the proponent to submit the Construction Period Erosion and Sedimentation Control Plan before commencing any land disturbance activity on the site.



Checklist for Stormwater Report

B. Stormwater Checklist and Certification

The following checklist is intended to serve as a guide for applicants as to the elements that ordinarily need to be addressed in a complete Stormwater Report. The checklist is also intended to provide conservation commissions and other reviewing authorities with a summary of the components necessary for a comprehensive Stormwater Report that addresses the ten Stormwater Standards.

Note: Because stormwater requirements vary from project to project, it is possible that a complete Stormwater Report may not include information on some of the subjects specified in the Checklist. If it is determined that a specific item does not apply to the project under review, please note that the item is not applicable (N.A.) and provide the reasons for that determination.

A complete checklist must include the Certification set forth below signed by the Registered Professional Engineer who prepared the Stormwater Report.

Registered Professional Engineer's Certification

I have reviewed the Stormwater Report, including the soil evaluation, computations, Long-term Pollution Prevention Plan, the Construction Period Erosion and Sedimentation Control Plan (if included), the Long-term Post-Construction Operation and Maintenance Plan, the Illicit Discharge Compliance Statement (if included) and the plans showing the stormwater management system, and have determined that they have been prepared in accordance with the requirements of the Stormwater Management Standards as further elaborated by the Massachusetts Stormwater Handbook. I have also determined that the information presented in the Stormwater Checklist is accurate and that the information presented in the Stormwater Report accurately reflects conditions at the site as of the date of this permit application.

Registered Professional Engineer Block and Signature

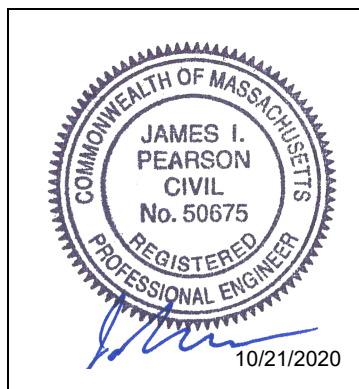

Signature and Date

10/21/2020

Checklist

Project Type: Is the application for new development, redevelopment, or a mix of new and redevelopment?

- New development
- Redevelopment
- Mix of New Development and Redevelopment



Checklist for Stormwater Report

Checklist (continued)

LID Measures: Stormwater Standards require LID measures to be considered. Document what environmentally sensitive design and LID Techniques were considered during the planning and design of the project:

- No disturbance to any Wetland Resource Areas
- Site Design Practices (e.g. clustered development, reduced frontage setbacks)
- Reduced Impervious Area (Redevelopment Only)
- Minimizing disturbance to existing trees and shrubs
- LID Site Design Credit Requested:
 - Credit 1
 - Credit 2
 - Credit 3
- Use of “country drainage” versus curb and gutter conveyance and pipe
- Bioretention Cells (includes Rain Gardens)
- Constructed Stormwater Wetlands (includes Gravel Wetlands designs)
- Treebox Filter
- Water Quality Swale
- Grass Channel
- Green Roof
- Other (describe): _____

Standard 1: No New Untreated Discharges

- No new untreated discharges
- Outlets have been designed so there is no erosion or scour to wetlands and waters of the Commonwealth
- Supporting calculations specified in Volume 3 of the Massachusetts Stormwater Handbook included.



Checklist for Stormwater Report

Checklist (continued)

Standard 2: Peak Rate Attenuation

- Standard 2 waiver requested because the project is located in land subject to coastal storm flowage and stormwater discharge is to a wetland subject to coastal flooding.
- Evaluation provided to determine whether off-site flooding increases during the 100-year 24-hour storm.
- Calculations provided to show that post-development peak discharge rates do not exceed pre-development rates for the 2-year and 10-year 24-hour storms. If evaluation shows that off-site flooding increases during the 100-year 24-hour storm, calculations are also provided to show that post-development peak discharge rates do not exceed pre-development rates for the 100-year 24-hour storm.

Standard 3: Recharge

- Soil Analysis provided.
- Required Recharge Volume calculation provided.
- Required Recharge volume reduced through use of the LID site Design Credits.
- Sizing the infiltration, BMPs is based on the following method: Check the method used.
 - Static
 - Simple Dynamic
 - Dynamic Field¹
- Runoff from all impervious areas at the site discharging to the infiltration BMP.
- Runoff from all impervious areas at the site is *not* discharging to the infiltration BMP and calculations are provided showing that the drainage area contributing runoff to the infiltration BMPs is sufficient to generate the required recharge volume.
- Recharge BMPs have been sized to infiltrate the Required Recharge Volume.
- Recharge BMPs have been sized to infiltrate the Required Recharge Volume *only* to the maximum extent practicable for the following reason:
 - Site is comprised solely of C and D soils and/or bedrock at the land surface
 - M.G.L. c. 21E sites pursuant to 310 CMR 40.0000
 - Solid Waste Landfill pursuant to 310 CMR 19.000
 - Project is otherwise subject to Stormwater Management Standards only to the maximum extent practicable.
- Calculations showing that the infiltration BMPs will drain in 72 hours are provided.
- Property includes a M.G.L. c. 21E site or a solid waste landfill and a mounding analysis is included.

¹ 80% TSS removal is required prior to discharge to infiltration BMP if Dynamic Field method is used.



Checklist for Stormwater Report

Checklist (continued)

Standard 3: Recharge (continued)

- The infiltration BMP is used to attenuate peak flows during storms greater than or equal to the 10-year 24-hour storm and separation to seasonal high groundwater is less than 4 feet and a mounding analysis is provided.
- Documentation is provided showing that infiltration BMPs do not adversely impact nearby wetland resource areas.

Standard 4: Water Quality

The Long-Term Pollution Prevention Plan typically includes the following:

- Good housekeeping practices;
 - Provisions for storing materials and waste products inside or under cover;
 - Vehicle washing controls;
 - Requirements for routine inspections and maintenance of stormwater BMPs;
 - Spill prevention and response plans;
 - Provisions for maintenance of lawns, gardens, and other landscaped areas;
 - Requirements for storage and use of fertilizers, herbicides, and pesticides;
 - Pet waste management provisions;
 - Provisions for operation and management of septic systems;
 - Provisions for solid waste management;
 - Snow disposal and plowing plans relative to Wetland Resource Areas;
 - Winter Road Salt and/or Sand Use and Storage restrictions;
 - Street sweeping schedules;
 - Provisions for prevention of illicit discharges to the stormwater management system;
 - Documentation that Stormwater BMPs are designed to provide for shutdown and containment in the event of a spill or discharges to or near critical areas or from LUHPPL;
 - Training for staff or personnel involved with implementing Long-Term Pollution Prevention Plan;
 - List of Emergency contacts for implementing Long-Term Pollution Prevention Plan.
- A Long-Term Pollution Prevention Plan is attached to Stormwater Report and is included as an attachment to the Wetlands Notice of Intent.
 - Treatment BMPs subject to the 44% TSS removal pretreatment requirement and the one inch rule for calculating the water quality volume are included, and discharge:
 - is within the Zone II or Interim Wellhead Protection Area
 - is near or to other critical areas
 - is within soils with a rapid infiltration rate (greater than 2.4 inches per hour)
 - involves runoff from land uses with higher potential pollutant loads.
 - The Required Water Quality Volume is reduced through use of the LID site Design Credits.
 - Calculations documenting that the treatment train meets the 80% TSS removal requirement and, if applicable, the 44% TSS removal pretreatment requirement, are provided.



Checklist for Stormwater Report

Checklist (continued)

Standard 4: Water Quality (continued)

- The BMP is sized (and calculations provided) based on:
 - The ½" or 1" Water Quality Volume or
 - The equivalent flow rate associated with the Water Quality Volume and documentation is provided showing that the BMP treats the required water quality volume.
- The applicant proposes to use proprietary BMPs, and documentation supporting use of proprietary BMP and proposed TSS removal rate is provided. This documentation may be in the form of the propriety BMP checklist found in Volume 2, Chapter 4 of the Massachusetts Stormwater Handbook and submitting copies of the TARP Report, STEP Report, and/or other third party studies verifying performance of the proprietary BMPs.
- A TMDL exists that indicates a need to reduce pollutants other than TSS and documentation showing that the BMPs selected are consistent with the TMDL is provided.

Standard 5: Land Uses With Higher Potential Pollutant Loads (LUHPPLs)

- The NPDES Multi-Sector General Permit covers the land use and the Stormwater Pollution Prevention Plan (SWPPP) has been included with the Stormwater Report.
- The NPDES Multi-Sector General Permit covers the land use and the SWPPP will be submitted **prior to** the discharge of stormwater to the post-construction stormwater BMPs.
- The NPDES Multi-Sector General Permit does **not** cover the land use.
- LUHPPLs are located at the site and industry specific source control and pollution prevention measures have been proposed to reduce or eliminate the exposure of LUHPPLs to rain, snow, snow melt and runoff, and been included in the long term Pollution Prevention Plan.
- All exposure has been eliminated.
- All exposure has **not** been eliminated and all BMPs selected are on MassDEP LUHPPL list.
- The LUHPPL has the potential to generate runoff with moderate to higher concentrations of oil and grease (e.g. all parking lots with >1000 vehicle trips per day) and the treatment train includes an oil grit separator, a filtering bioretention area, a sand filter or equivalent.

Standard 6: Critical Areas

- The discharge is near or to a critical area and the treatment train includes only BMPs that MassDEP has approved for stormwater discharges to or near that particular class of critical area.
- Critical areas and BMPs are identified in the Stormwater Report.



Checklist for Stormwater Report

Checklist (continued)

Standard 7: Redevelopments and Other Projects Subject to the Standards only to the maximum extent practicable

- The project is subject to the Stormwater Management Standards only to the maximum Extent Practicable as a:
 - Limited Project
 - Small Residential Projects: 5-9 single family houses or 5-9 units in a multi-family development provided there is no discharge that may potentially affect a critical area.
 - Small Residential Projects: 2-4 single family houses or 2-4 units in a multi-family development with a discharge to a critical area
 - Marina and/or boatyard provided the hull painting, service and maintenance areas are protected from exposure to rain, snow, snow melt and runoff
 - Bike Path and/or Foot Path
- Redevelopment Project
- Redevelopment portion of mix of new and redevelopment.
- Certain standards are not fully met (Standard No. 1, 8, 9, and 10 must always be fully met) and an explanation of why these standards are not met is contained in the Stormwater Report.
- The project involves redevelopment and a description of all measures that have been taken to improve existing conditions is provided in the Stormwater Report. The redevelopment checklist found in Volume 2 Chapter 3 of the Massachusetts Stormwater Handbook may be used to document that the proposed stormwater management system (a) complies with Standards 2, 3 and the pretreatment and structural BMP requirements of Standards 4-6 to the maximum extent practicable and (b) improves existing conditions.

Standard 8: Construction Period Pollution Prevention and Erosion and Sedimentation Control

A Construction Period Pollution Prevention and Erosion and Sedimentation Control Plan must include the following information:

- Narrative;
 - Construction Period Operation and Maintenance Plan;
 - Names of Persons or Entity Responsible for Plan Compliance;
 - Construction Period Pollution Prevention Measures;
 - Erosion and Sedimentation Control Plan Drawings;
 - Detail drawings and specifications for erosion control BMPs, including sizing calculations;
 - Vegetation Planning;
 - Site Development Plan;
 - Construction Sequencing Plan;
 - Sequencing of Erosion and Sedimentation Controls;
 - Operation and Maintenance of Erosion and Sedimentation Controls;
 - Inspection Schedule;
 - Maintenance Schedule;
 - Inspection and Maintenance Log Form.
- A Construction Period Pollution Prevention and Erosion and Sedimentation Control Plan containing the information set forth above has been included in the Stormwater Report.



Checklist for Stormwater Report

Checklist (continued)

Standard 8: Construction Period Pollution Prevention and Erosion and Sedimentation Control (continued)

- The project is highly complex and information is included in the Stormwater Report that explains why it is not possible to submit the Construction Period Pollution Prevention and Erosion and Sedimentation Control Plan with the application. A Construction Period Pollution Prevention and Erosion and Sedimentation Control has **not** been included in the Stormwater Report but will be submitted **before** land disturbance begins.
- The project is **not** covered by a NPDES Construction General Permit.
- The project is covered by a NPDES Construction General Permit and a copy of the SWPPP is in the Stormwater Report.
- The project is covered by a NPDES Construction General Permit but no SWPPP been submitted. The SWPPP will be submitted BEFORE land disturbance begins.

Standard 9: Operation and Maintenance Plan

- The Post Construction Operation and Maintenance Plan is included in the Stormwater Report and includes the following information:
 - Name of the stormwater management system owners;
 - Party responsible for operation and maintenance;
 - Schedule for implementation of routine and non-routine maintenance tasks;
 - Plan showing the location of all stormwater BMPs maintenance access areas;
 - Description and delineation of public safety features;
 - Estimated operation and maintenance budget; and
 - Operation and Maintenance Log Form.
- The responsible party is **not** the owner of the parcel where the BMP is located and the Stormwater Report includes the following submissions:
 - A copy of the legal instrument (deed, homeowner's association, utility trust or other legal entity) that establishes the terms of and legal responsibility for the operation and maintenance of the project site stormwater BMPs;
 - A plan and easement deed that allows site access for the legal entity to operate and maintain BMP functions.

Standard 10: Prohibition of Illicit Discharges

- The Long-Term Pollution Prevention Plan includes measures to prevent illicit discharges;
- An Illicit Discharge Compliance Statement is attached;
- NO Illicit Discharge Compliance Statement is attached but will be submitted **prior to** the discharge of any stormwater to post-construction BMPs.

Stormwater Report
October 21, 2020
To Be Submitted with the Notice of Intent

Applicant/Project Name: City of Boston – McConnell Park

Project Address: 98-49 Denny Street, Boston MA 02125

Application Prepared by:

Firm: Weston & Sampson, Inc.

Registered PE: James I. Pearson, PE

General:

The City of Boston proposes to redevelop McConnell Park off Denny Street. The park in its existing conditions consists of three ballfields on the western portion of the site, a parking area in the middle of the site, and an open grass area to the east. There is also a small shaded play area with assorted play structures on the southern edge of the parcel. The park is bordered to the south by Dorchester Bay, and is bordered to the north by a residential area. Site improvements will include three new ballfields, a new playground, ADA accessibility upgrades, pedestrian walkways, and seating areas to encourage increased public usage of the park. This project will allow the City of Boston to utilize McConnell Park that meets current and future needs while also drawing more recreational activities to the area. Work associated with this project will include but not be limited to paving, grading and installation of drainage infrastructure.

The site is adjacent to one wetland resource areas: a coastal beach along Dorchester Bay, the southern boundary of the site. Some work will occur within 100-feet of this resource area, protected under the Wetlands Protection Act. Some work will also occur within the 100-year flood zone. NRCS soil mapping describes the area as being a mixture of urban land, wet substratum and beaches, sand. Geotechnical exploration on site has generally confirmed the soil survey data, boring and test pit logs are included with this report in Attachment C.

Design Standards

The proposed project is subject to the standards of the Massachusetts Stormwater Handbook. Below is an explanation concerning Standards 1-10 as they apply to the City of Boston McConnell Park, located on Plainfield Road:

Standard 1: No New Untreated Discharges

The proposed project will create no new untreated discharges. Impervious area will be increased in comparison with existing conditions. Stormwater runoff

generated from the new paved parking and driveway areas will be treated prior to discharge to Dorchester Bay. HydroCAD modeling of the site is provided in Attachment D.

Standard 2: Peak Rate Attenuation

Existing and proposed conditions were modeled using HydroCAD software. The proposed design mitigates peak flows for the 2-year, 10-year, 25-year, and 100-year 24-hour storm events. Infiltration rates used for the site were based on site soils that have been characterized as belonging to Hydrologic Soil Group A, verified by NRCS Soil Mapping and onsite test pits (Attachment B). The infiltration rates were obtained from the Rawls Rate table in the Stormwater Handbook. A table summarizing peak discharges can be found in Attachment D.

To ensure that the work incorporates the performance standards recommended in the DEP's Stormwater Management Policy, necessary erosion and sedimentation control measures will be utilized during construction. These measures will include compost filter tubes, catch basin protection, and a stabilized construction entrance, as depicted on the site plans.

Standard 3: Recharge

Due to the increase in impervious area, the Required Recharge Volume for the site is 526 cubic feet. The available volume from the the subsurface infiltration systems site-wide is 5,073 cubic feet. This reflects the amount of volume available in infiltration basins and subsurface structures below the elevation of any outlet device. See Attachment E for all recharge and water quality calculations. Infiltration areas are required to have a maximum drawdown time of 72 hours. The infiltration area hydrographs in the HydroCAD model in Attachment D show that this requirement is achieved.

Standard 4: Water Quality

This is a redevelopment project, and standard 4 will be met to the maximum extent practicable. All of the stormwater from impervious parking and driveway areas on the site will undergo treatment to bring TSS levels within regulated limits (>80% removal). Depending on the drainage area, stormwater will undergo treatment from one of two options: 1) Deep Sump Catch basin, and a subsurface infiltration system with isolator rows or 2) Pea stone diaphragms, raingardens, and a subsurface infiltration system with isolator rows. During the project, appropriate BMPs will be used to minimize sedimentation and soil erosion. All impervious areas on site for pedestrian/non-vehicular use will not generate a significant TSS load. Adequate water quality volume has been provided, see the calculation in Attachment E.

Standard 5: Land Uses with Higher Potential Pollutant Loads (LUHPPLs)

The park improvements are not a land use with higher potential pollutant load.

Standard 6: Critical Areas

There will be no new discharge to critical areas.

Standard 7: Redevelopments and Other Projects Subject to the Standards Only to the Maximum Extent Practicable

The project is a redevelopment.

Standard 8: Construction Period Pollution Prevention and Erosion and Sediment Control

A detailed Construction Period Pollution Prevention and Erosion and Sedimentation Control Plan is included in Attachment G. To ensure that the work incorporates the performance standards recommended in the DEP's Stormwater Management Policy, necessary erosion and sedimentation control measures will be utilized during construction. These measures will include compost filter tubes, and catch basin protection, as depicted on the site plans.

Standard 9: Operation and Maintenance Plan

An operations and maintenance plan is included in Attachment H.

Standard 10: Prohibition of Illicit Discharges

An illicit discharge compliance statement has been included in Attachment I.

Registered Professional Engineer's Certification

I have reviewed the Stormwater Report, including any relevant soil evaluations, computations, Long-term Pollution Prevention Plan, the Construction Period Erosion and Sedimentation Control Plan, the Long-term Post-Construction Operation and Maintenance Plan, the Illicit Discharge Compliance Statement and the plans showing the stormwater management system, and have determined that they have been prepared in accordance with the requirements of the Stormwater Management Standards as further elaborated by the Massachusetts Stormwater Handbook. I have also determined that the information presented in the Stormwater Checklist is accurate and that the information presented in the Stormwater Report accurately reflects conditions at the site as of the date of this permit application.

Registered Professional Engineer Block and Signature



Signature and Date

10/21/2020

Attachment A - Locus Map



Legend

 Work Area

FIGURE 1

McCConnell Playground
Boston, MA

Locus Map

Copyright © 2013 National Geographic Society, i-cubed

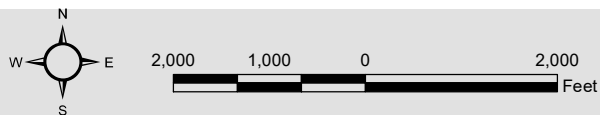

Data Source: Office of Geographic and Environmental Information (MassGIS),
Commonwealth of Massachusetts Executive Office of Environmental Affairs

Weston & SampsonSM

**Attachment B - NRCS Soils Map, Soils Report, and HSG
Classifications**

Hydrologic Soil Group—Norfolk and Suffolk Counties, Massachusetts
(McConnell Playground HSG Map)



Map Scale: 1:2,430 if printed on A landscape (11" x 8.5") sheet.

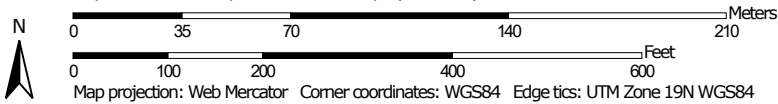

MAP LEGEND

Area of Interest (AOI)









 Area of Interest (AOI)

Soils

Soil Rating Polygons





 A
 A/D
 B
 B/D
 C
 C/D
 D
 Not rated or not available

Soil Rating Lines

 A
 A/D
 B
 B/D
 C
 C/D
 D
 Not rated or not available

Soil Rating Points





 A
 A/D
 B
 B/D

 C
 C/D
 D
 Not rated or not available

Water Features

 Streams and Canals

Transportation

 Rails
 Interstate Highways
 US Routes
 Major Roads
 Local Roads

Background

 Aerial Photography

MAP INFORMATION

The soil surveys that comprise your AOI were mapped at 1:25,000.

Warning: Soil Map may not be valid at this scale.

Enlargement of maps beyond the scale of mapping can cause misunderstanding of the detail of mapping and accuracy of soil line placement. The maps do not show the small areas of contrasting soils that could have been shown at a more detailed scale.

Please rely on the bar scale on each map sheet for map measurements.

Source of Map: Natural Resources Conservation Service
 Web Soil Survey URL:
 Coordinate System: Web Mercator (EPSG:3857)

Maps from the Web Soil Survey are based on the Web Mercator projection, which preserves direction and shape but distorts distance and area. A projection that preserves area, such as the Albers equal-area conic projection, should be used if more accurate calculations of distance or area are required.

This product is generated from the USDA-NRCS certified data as of the version date(s) listed below.

Soil Survey Area: Norfolk and Suffolk Counties, Massachusetts
 Survey Area Data: Version 15, Sep 12, 2019

Soil map units are labeled (as space allows) for map scales 1:50,000 or larger.

Date(s) aerial images were photographed: Sep 11, 2019—Oct 5, 2019

The orthophoto or other base map on which the soil lines were compiled and digitized probably differs from the background imagery displayed on these maps. As a result, some minor shifting of map unit boundaries may be evident.

Hydrologic Soil Group

Map unit symbol	Map unit name	Rating	Acres in AOI	Percent of AOI
1	Water		2.5	8.6%
105D	Rock outcrop-Hollis complex, 3 to 25 percent slopes		1.3	4.4%
603	Urban land, wet substratum, 0 to 3 percent slopes		13.4	45.9%
610	Beaches, sand		4.2	14.5%
626B	Merrimac-Urban land complex, 0 to 8 percent slopes	A	7.8	26.6%
Totals for Area of Interest			29.2	100.0%

Description

Hydrologic soil groups are based on estimates of runoff potential. Soils are assigned to one of four groups according to the rate of water infiltration when the soils are not protected by vegetation, are thoroughly wet, and receive precipitation from long-duration storms.

The soils in the United States are assigned to four groups (A, B, C, and D) and three dual classes (A/D, B/D, and C/D). The groups are defined as follows:

Group A. Soils having a high infiltration rate (low runoff potential) when thoroughly wet. These consist mainly of deep, well drained to excessively drained sands or gravelly sands. These soils have a high rate of water transmission.

Group B. Soils having a moderate infiltration rate when thoroughly wet. These consist chiefly of moderately deep or deep, moderately well drained or well drained soils that have moderately fine texture to moderately coarse texture. These soils have a moderate rate of water transmission.

Group C. Soils having a slow infiltration rate when thoroughly wet. These consist chiefly of soils having a layer that impedes the downward movement of water or soils of moderately fine texture or fine texture. These soils have a slow rate of water transmission.

Group D. Soils having a very slow infiltration rate (high runoff potential) when thoroughly wet. These consist chiefly of clays that have a high shrink-swell potential, soils that have a high water table, soils that have a claypan or clay layer at or near the surface, and soils that are shallow over nearly impervious material. These soils have a very slow rate of water transmission.

If a soil is assigned to a dual hydrologic group (A/D, B/D, or C/D), the first letter is for drained areas and the second is for undrained areas. Only the soils that in their natural condition are in group D are assigned to dual classes.

Rating Options

Aggregation Method: Dominant Condition

Component Percent Cutoff: 1

Tie-break Rule: Higher

Attachment C - Test Pit Summary and Logs

**Boston Parks and Recreation Department
Weston & Sampson Project No. 2160850**

July 22, 2020

Boston Parks and Recreation Department
c/o Cheri Ruane, FASLA
Weston & Sampson
85 Devonshire Street, 3rd Floor
Boston, MA 02109

**RE: Geotechnical Engineering Report
Improvements to McConnell Park
Boston, Massachusetts**

INTRODUCTION

Weston & Sampson Engineers, Inc. (Weston & Sampson) is pleased to present this geotechnical engineering report summarizing our subsurface explorations and geotechnical recommendations for design and construction of the proposed Improvements to McConnell Park project in Boston, Massachusetts. Our project understanding is based on review of 90% Construction Documents prepared by Weston & Sampson and dated June 30, 2020.

For important information on the limitations and use of this report, please refer to the **Limitations** section of this report. Environmental services were not included in our project scope; therefore, we recommend the Licensed Site Professional (LSP) for the project evaluate the site for environmental concerns. Our explorations at the site did encounter evidence of potential environmental contamination.

SITE HISTORY

Weston & Sampson completed a desktop review of the project site, which included review of historical aerial imagery and maps, and the book *Gaining Ground: A History of Landmaking in Boston* (Seasholes, 2003). An 1896 U.S. Coast & Geodetic Survey Boston Harbor Chart depicts the area west of what is currently the parking area as an area of salt marsh. The southwest corner of the current site extends beyond what is shown as coastline on the 1896 harbor chart (i.e. formerly under water). Figure 12.1 in *Gaining Ground* depicts an approximated historical 1630 coastline and is generally consistent with the 1896 NOAA chart described above in the vicinity of McConnell Park. According to *Gaining Ground*, a dike was created by filling across existing land and tidal flats to create Savin Hill Beach around 1900, along what is currently the southern edge of the site. Around 1908, the existing salt marsh behind this dike was filled with hydraulically dredged material from Dorchester Bay to create what is now McConnell Park. Sand was also placed on the

previously gravel Savin Hill Beach. Construction of a seawall along the newly formed coastline, and additional filling to raise grades behind the seawall, was completed in 1918.

EXISTING CONDITIONS

McConnell Park (the site) is located in an urban, residential area of Boston, Massachusetts. The approximately 6.3-acre site is bound by Springdale Street and residential areas to the north and east, Dorchester Bay Basin, Savin Hill Beach, and the Dorchester Yacht Club to the south, and the eight-lane Southeast Expressway (Interstate 93/State Route 1) to the west, as shown in **Figure 1 – Proposed Site Plan**. The existing site is developed with three baseball/softball fields with bleacher seating and sports lighting, a playground, landscaped areas, and asphalt-paved walking paths. Asphalt-paved parking areas are present near the entrance to the park along Springdale Street and Denny Street and to the south of the park. A stone monument is present in an elevated landscaped area to the east of the playground. A retaining wall with exposed heights up to approximately 2 feet (ft.) divides the park area from the adjacent Savin Hill Beach.

Existing utilities at the site include below grade and overhead electric, and below grade water and sewer. A 42-inch diameter sewer crosses the southwest corner of the site. An approximately 96-inch by 120-inch sewer extends along the first base line of the southwest baseball field and to the north of the Savin Hill Beach wall at an offset of approximately 17 to 18 ft. An additional 42-inch sewer extends south from Denny Street to the 96-inch by 120-inch sewer.

The site is generally flat in the vicinity of the playing fields, playground, and parking areas with ground surface elevations ranging from approximately El. 13 to 15. Surface elevations increase gently to the east of the playground and generally range between El. 16 and 27. Steeper grades up to approximately 1.7H:1V (horizontal: vertical) are present between this elevated landscaped area to the east of the playground and the beach to the south. Elevations described herein are in ft. and reference the Boston City Base (BCB) datum.

PROPOSED CONDITIONS

The proposed project includes construction of three new sports fields, including a natural turf, 250 ft. by 150 ft. multi-purpose field with baseball diamond, natural turf little league baseball field, and synthetic turf “Challenger” baseball field, new dugouts, backstops, and bleacher seating, eleven new sports light poles, portable restroom shelter, a new playground, speed table plaza with raised crosswalks, landscaped areas, and new asphalt-paved parking areas. The approximate locations of these features are shown in **Figure 1**.

Based on our experience with similar projects, we assume the pole foundations will consist of precast concrete piers placed in drilled boreholes and the bathroom shelter and playground equipment will be supported on shallow foundations.

Proposed grades at the site are generally within approximately 1 ft. of existing grades except in the following areas: raised berm areas up to approximately 3 ft. over existing grades along the western border of the site; cuts up to approximately 3 ft. below existing grade in the vicinity of the proposed green infrastructure/detention basin at the northeast corner of the site; grade increases up to

approximately 2.5 ft. over existing grades east of the playground area. Proposed grading is presented in *Figure 2. Grading Plan*.

SUBSURFACE CONDITIONS

Geologic Setting

Information from the Massachusetts Office of Geographic Information Systems (MassGIS) indicates the site is generally in an area of artificial fill soils. The area east of Denny Street and the parking area is mapped as glacial till. A small area at the northeast corner of the site is mapped as glaciomarine fine grained soils. The Bedrock Geologic Map of Massachusetts indicates bedrock at the site consists of conglomerate, sandstone, siltstone, argillite and melaphyre of the Roxbury Conglomerate. An area of abundant rock outcrops is indicated approximately 400 ft. northeast of the site however, bedrock outcrops were not observed during our site reconnaissance.

Subsurface Explorations

Subsurface conditions at the site were explored between June 15 and 18, 2020 by advancing eight borings (B-1 through B-8) to depths ranging from 18.3 to 42 ft. and on June 17, 2020 by completing five test pits (TP-1 through TP-5) to depths ranging from 6.2 to 11 ft. Approximate exploration locations are shown in *Figure 1*.

The explorations were completed by Technical Drilling Services of Sterling, MA using an ATV-mounted drill rig and New Holland 555E Backhoe. B-1 was advanced using 4-1/4-inch inside-diameter (ID) hollow-stem augers. All other borings were advanced using 4-inch ID flush-joint casing and drive-and-wash drilling methods. Standard penetration tests (SPTs) and sampling were conducted in each boring by driving a 24-inch long by 1-3/8-inch inside diameter (2-inch outside diameter) split spoon sampler with blows from a 140 lb. automatic hammer falling 30 in. per blow. Sampling intervals ranged from continuous (every 2 feet) to standard (every 5 feet). The blow counts for the middle 12 in. of sampler penetration are combined and designated as the SPT blow count, which is correlated to soil consistencies and engineering soil properties.

Select soil samples from the explorations were screened for the presence of Volatile Organic Compounds (VOCs) using a photoionization detector (PID). PID readings are depicted on the attached *Boring Logs*.

Weston & Sampson geotechnical engineering staff monitored the borings and test pits in the field and prepared logs for each exploration. Descriptions of the subsurface conditions encountered are provided in the boring logs included in *Attachment A* and in the test pit logs included in *Attachment B*. General descriptions of the subsurface conditions encountered are provided in the following section.

Subsurface Conditions

Subsurface conditions in the explorations below surficial topsoil or infield mix generally consisted of manmade fill above layers of peat, loose marine sediments, native clay and glacial till. In general, the test pits were terminated in the surficial manmade fill or peat (TP-5).

The major strata encountered in the explorations are described below. Variations may occur and should be expected outside and between exploration locations.

Infield Mix – In B-6 and B-8, completed within the existing baseball infields, the surficial material consisted of 5 inches of infield mix.

Topsoil – Approximately 4 to 13 inches of topsoil was encountered at the ground surface in all explorations except B-6 and B-8.

Fill –Very loose to dense undocumented fill was encountered below the topsoil or infield mix in all explorations to depth ranging between 6 and 16 ft. The fill was not fully penetrated in TP-1 through TP-4. The fill most frequently consisted of silty sand with gravel and was generally coarse-grained however, was highly variable and also included silt and clay material in some explorations. Seams of peat were observed within the fill in B-7 from approximately 8 to 13 ft. The fill frequently included debris such as wood, slag, cinders, porcelain, leather, glass, and concrete. A petroleum-like odor was noted for fill samples from B-1, B-2, B-4, and B-5. Auger or roller bit grinding on possible cobbles or debris was noted within the fill in B-1, B-2, B-3, B-6, and B-7. Difficult excavation was noted within the fill in TP-2 and TP-5.

Peat/Organic Silt – Very soft to medium stiff peat was encountered in B-1, B-3, B-4, B-5, B-8 and TP-5 underlying the undocumented fill or marine sediment. The peat transitioned to an organic silt in B-8. The peat was typically fibrous with a spongy texture and ranged in thickness from approximately 2.5 to 8.5 ft.

Marine Sediment with Organics – Very soft marine sediment consisting of mostly medium plasticity clay, few to little fine to medium sand, and up to trace fine gravel was encountered in B-1, B-4, B-6 and B-7 underlying the fill. The marine sediment typically included occasional shells and trace organics (plant fibers). Pocket penetrometer values in the marine sediment typically ranged from 0.1 to 0.2 tons per square foot (tsf) and Torvane values ranged from 0.1 to 0.2 tsf.

Marine Clay – Medium stiff to very stiff native clay was encountered underlying the peat or marine sediment in all borings except B-2 at depths ranging from 11.5 to 38 ft. The native clay occasionally included sand seams but generally consisted of mostly medium plasticity clay with trace to few fine sand and up to trace gravel. Pocket penetrometer values in the native clay typically ranged from 0.8 to 4.5 tons per square foot (tsf) and Torvane values ranged from 0.3 to 0.8 tsf.

Glacial Till – Very dense glacial till was encountered in B-2 and B-3 at depths of 14 and 16 ft. respectively. The glacial till generally consisted of some to mostly fine to coarse sand with some gravel and few to little non-plastic fines. Roller bit grinding and slow drilling was noted in the glacial till in both borings where encountered.

Refusal – Sampler refusal is defined as greater than 50 blows for 6 inches of sampler penetration. Drilling refusal is defined as no discernable auger or roller bit advancement over a period of at least 5 minutes. Sampler refusal was obtained at approximately 17.7 ft. in B-2 and 21.5 ft. in B-3. Drilling refusal was obtained at approximately 18.3 ft. in B-2.

Groundwater - Groundwater was encountered in all borings at depths ranging from approximately 4.5 to 7 ft. (El. 7.5 to El. 10) based on observation of wet samples and measurements in the boreholes. Groundwater seepage was observed in all test pits except TP-5 at depths ranging from approximately 4 to 6.5 ft. (El. 6.5 to El. 10). We anticipate groundwater levels will fluctuate with season, variations in precipitation, tides, construction in the area, and other factors. Perched groundwater conditions could exist close to the ground surface, especially during and after periods of wet weather.

GEOTECHNICAL LABORATORY TEST RESULTS

Geotechnical laboratory testing was completed on seven samples from the borings to confirm field descriptions and determine engineering properties of the soil. One grain size analysis (ASTM D6913) was performed on a fill sample from B-3, four organic content tests (ASTM D2974) were performed on peat and marine sediment samples from B-1, B-3, B-7 and B-8, and two Atterberg Limit tests (ASTM D4318) were completed on marine sediment and native clay samples from B-1 and B-6. Laboratory test results are included in ***Attachment C – Geotechnical Laboratory Test Results***.

GEOTECHNICAL DESIGN RECOMMENDATIONS

Primary Geotechnical Concerns

Based on the results of our subsurface explorations and geotechnical analyses, the proposed site development is feasible following the recommendations presented in the following sections. The primary geotechnical considerations for the project include the presence of variable, undocumented fill and very soft, and compressible organic soils and marine sediments. The site stratigraphy varies considerably across the site due to natural geologic features and historic site fills. Although the proposed fill thickness is small across the majority of proposed athletic fields, differential settlement should be expected to vary across dimensionally large loaded areas with large settlements expected below areas where thicker deposits of peat and marine deposits are present. Shallow groundwater was encountered at proposed light pole locations and near playground equipment foundations, and difficult excavation may be encountered in the undocumented fill due to the presence of debris and possible cobbles or boulders.

The existing fill may provide adequate support for planned reinforced concrete slabs, the restroom shelter and playground equipment foundations provided the subgrades are prepared and evaluated as recommended in this report. Differential settlement may occur over time due to the variable nature of the fill and underlying soft, compressible soils and these structures should be designed to accommodate this as much as possible. Organic soils will continue to settle as a result of secondary consolidation from previously placed fill loads and the decomposition of organic material. We should be contacted if the estimated settlements for structures and general park improvements discussed herein or pavements are not within the required design tolerance and we can provide recommendations to limit settlement through ground improvement or similar measures. However, we assume typical ground improvement or deep foundation alternatives are likely cost-prohibitive for the types of improvements being proposed.

Thick deposits of soft, compressible organics soils and marine sediments are present at the site. In general, these layers will provide limited lateral resistance and bearing capacity and can be expected to settle under net load increases due raise in grade or structural loads. We understand that foundations for sports lighting structures will be designed by the manufacturer. Foundations for proposed sports lighting structures will need sufficient embedment to resist compression, uplift, and overturning loading and should extend through the existing fill, organic, and soft marine sediment layers and into the native, medium stiff or stiffer clay or medium dense or denser glacial till. We recommend that grade increases be limited as much as practicable to reduce the potential for damage to proposed site features and existing subsurface utilities due to differential settlement.

Groundwater was encountered at the site at depths greater than 4.5 ft. and may be encountered in excavations at the site. If encountered in excavations, dewatering will be necessary prior to placement of overlying fill or forms and rebar.

Difficult excavation and frequent debris, cobbles, and boulders should be expected in the undocumented fill. Moderately difficult to difficult excavation was noted in test pits completed at the site and auger or roller bit grinding was noted in the borings. Due to the nature of the fill and potential environmental concerns, special precautions and/or measures may be required for handling of fill soils and groundwater.

Settlement Analyses

Based on our analyses, about 2 to 6 inches of long-term, consolidation settlement should be expected within the 40 years following construction in improvement areas where mass fill placement with 1 ft. of engineered fill materials is planned. The higher end of the settlement range is anticipated in the south to southwest portion of the Site where thicker compressible soil layers exist. Where grades will be raised up to approximately 3 ft. at the berms along the western edge of the site and areas of grade increases east of the playground, over 1 ft. of long-term settlement is expected and additional fill material may need to be placed after 5 to 10 years if poor surface drainage develops and/or the resulting surface contours are undesirable.

Differential settlement and significant cracking of overlying pavements or other hard surfaces should be expected in areas with grade increases. Grade increases should be limited as much as possible in the vicinity of these types of improvements. Likewise, the amount of fill should be limited in areas where historic utilities traverse the site.

Typical settlement mitigation strategies such as deep foundation elements or ground improvement are likely cost prohibitive for the proposed improvements at the park. Use of a lightweight fill material such as foamed glass aggregate or expanded shale are a mitigative solution in grade increase areas to limit induced settlement if the anticipated range of settlement is a concern. If the utility owner requires a zero net pressure increase over the pipelines, a portion of the existing subgrade may be undercut and replaced with lightweight fill. We can provide specific mitigative design sections if required.

Shallow Foundations

The proposed playground equipment and bathroom shelter can be supported on shallow foundations bearing in undisturbed, medium dense (or denser) undocumented fill, or on properly

constructed Structural Fill overlying such soils. Footings bearing entirely on these materials can be designed using an allowable bearing pressure of 1,000 pounds per square foot (psf). The allowable bearing pressure will be governed by settlement as opposed to bearing capacity failure. Spread and continuous (strip) footing foundations loaded up to 1,000 psf and constructed as recommended herein are anticipated to undergo total settlements less than approximately 1.5 inches. Resistance to lateral loads can be obtained by a footing base friction coefficient of 0.45 and ignoring any lateral resistance provided by the undocumented fill soil. We recommend a minimum factor of safety of 1.5 when using sliding friction alone.

All foundation subgrades should be observed by a Weston & Sampson geotechnical engineer prior to placement of overlying fill and foundation forms and rebar. If cobbles, boulders or similar-sized debris are present at foundation subgrades, they should be overexcavated and replaced with compacted structural fill.

Foundations should be designed in accordance with the provisions of the current edition of the Massachusetts State Building Code. Footings should be embedded at least 4 ft. below the nearest proposed adjacent ground surface exposed to freezing.

Concrete Pads and Pavements

Our analyses indicate up to approximately 6 inches of long-term settlement is expected in improvement areas where grades are raised less than approximately 1 ft. This magnitude of differential settlement is considered tolerable for the proposed fields and lightly loaded playground structures however significant cracking is likely to develop in hard surfaces such as concrete slabs and asphalt concrete pavements and will likely require periodic crack repair. Consideration should be given to a stabilized aggregate material in place of asphalt concrete pavement where asphalt concrete pavements are proposed in areas with grade increases greater than approximately 1 ft.

Concrete pads supporting the dugout structures, bleachers, and restroom shelter can bear on existing undocumented granular fill. Based on subgrade preparation procedures recommended in this report and existing soil conditions, a subgrade modulus (k) of 150 pounds per cubic inch (pci) is recommended for concrete pad design. The suitability of the existing undocumented fill to support concrete pads should be evaluated by a Weston & Sampson geotechnical engineer prior to the placement of overlying fill, reinforcing steel, and foundation forms.

A minimum of 12-inches of 1-1/2-inch crushed stone is recommended as underslab fill below the concrete pads separated by filter fabric along edges meeting in-situ soils. Underslab fill should be placed in 6-inch thick maximum loose lifts with each lift compacted until well keyed. Any areas contaminated with fines or debris should be removed and replaced with clean stone. If the underslab stone is saturated or retaining water, the water should be removed prior to slab placement.

Sports Fields

The proposed artificial turf field can be constructed as proposed. Proposed grades should match existing grades as much as possible to limit settlement and adverse effects on the field surface. Any large debris, cobbles, or boulders present within approximately 2 ft. below the proposed

artificial turf surface should be overexcavated and replaced with compacted structural fill to limit differential settlement or depression in the turf surface.

Seismic Considerations

In accordance with the International Building Code (IBC) as adapted by the Commonwealth of Massachusetts State Building Code and based on our explorations and analyses, the subject project should be evaluated using parameters associated with Site Class E due to the presence of peat. Based on soil types and consistencies encountered in our explorations, the risk of structurally damaging ground deformations related to liquefaction is moderate.

Light Pole Foundations

Light pole foundations typically consist of cylindrical precast concrete bases installed in drilled shafts and backfilled with structural concrete. The light pole foundations should be designed in accordance with the provisions of Section 1807.3 (Embedded Posts and Poles) of the 2018 International Building Code (IBC), the provisions of the current edition of the Massachusetts State Building Code and the Technical Specifications provided by the light pole manufacturer.

Precast foundations for the sports light poles should penetrate the undocumented fill, peat and organic soils, and soft marine sediment, and derive base support in native, inorganic soils. Difficult excavation and the presence of cobbles and boulders, caving soils, and groundwater infiltration should be expected. All loose and disturbed materials should be removed from the base of the shaft prior to placement of the precast base. The use of casing may be necessary to maintain the borehole sidewalls and limit caving of the shaft excavation.

An allowable bearing pressure of 2,000 psf for light poles bearing in native, medium stiff or stiffer clay and 4,000 psf for light poles bearing in native sand or glacial till can be used at the base of the shaft to resist axial loads provided all loose material and slough is removed from the bored hole prior to placement of the precast light pole base and concrete backfill. Skin friction along the shaft sidewall should be ignored when calculating resistance to axial loads.

Resistance to lateral loads can be calculated using the soil parameters in the following table. Resistance in the peat and organic soils and top 2 feet of foundation embedment should be ignored. Groundwater should be assumed to be at the ground surface for design of foundations.

Soil Parameter	Fill	Marine Sediment with Organics	Marine Clay	Glacial Till
Submerged Unit Weight, lbs/ft ³	48	43	53	68
Soil Angle of Internal Friction, ϕ , degrees	29	26	28	34
Coefficient of Passive Earth Pressure, K_p (Rankine)	2.9	2.6	2.8	3.5

The foundation designer and contractor should be responsible for selecting appropriate construction methods to assure each foundation is constructed in accordance with project design drawings and specifications. The presence of obstructions (cobbles, boulders and debris) and need for removal should be anticipated. The presence of caving soils and/or groundwater infiltration in foundation excavations could require the use of casing or drilling slurry to maintain excavation integrity. Cleanout buckets may be required to remove loose and unstable material from the shaft base. A Weston & Sampson geotechnical engineer should observe the base conditions at each foundation location prior to concrete and reinforcing steel placement. Tremie methods should be utilized to install concrete if water is present at the bottom of the excavations.

CONSTRUCTION CONSIDERATIONS

Site Preparation

Site preparation for earthwork will require removal of all vegetation, organic topsoil, and existing site features below all concrete slabs, foundations, pavements, artificial turf fields, and raise-in-grade fill areas, including a 5 ft. perimeter around these areas. Existing, granular, medium dense or denser undocumented fill may remain in place below bathroom shelter and playground equipment foundations and below new concrete slabs and pavements provided the subgrades are prepared and evaluated as recommended in this report. Subgrades where fill is left in place may require some rework and compaction.

Difficult excavation and the presence of cobbles, boulders, and debris should be expected in excavations at the site.

Excavation Considerations

Excavation will be required for site preparation, grading, and construction of slabs, foundations, pavements, sports fields, and utilities. Surface water should be controlled during construction and prevented from eroding temporary slopes and disturbing excavation and subgrade materials. If

excavations encounter groundwater, moderate to severe caving should be expected where seepage is present.

All excavations should be made in accordance with applicable OSHA safety regulations. Temporary excavation support may be required depending on depths of excavations and if excavations need to approach the zone-of-influence beneath existing structures or other site features. Excavation support systems, if necessary, should be the responsibility of the contractor and designed by a Professional Engineer licensed in the Commonwealth of Massachusetts. Foundations and utilities should be designed and constructed so that excavations into zones-of-influences below and adjacent to footings are not required.

Depending on excavation depths and amount of groundwater seepage, dewatering may be necessary. Flow rates for dewatering are likely to vary depending on location, soil type, and the season during which the excavation occurs. The dewatering system should be capable of lowering the groundwater table at least 2 ft. below the anticipated excavation depths and be kept operational until fill placement and compaction and concrete installation have been completed to at least 2 ft. above the groundwater table elevation. The dewatering system should be capable of handling variable flow rates and should be the responsibility of the contractor.

Subgrade Preparation and Stabilization

Following stripping and removal of unsuitable soils, subgrades in medium dense or denser, granular fill should be compacted until firm and stable with several passes of a minimum 10-ton vibrator roller. Areas with limited access can be compacted using several passes of a 700-pound plate compactor. A Weston & Sampson geotechnical engineer should evaluate exposed subgrades prior to placement of overlying materials.

Soft and/or disturbed areas will require over-excavation and backfilling with compacted angular crushed stone or compacted Structural Fill as recommended by the geotechnical engineer. A geosynthetic separation layer between the excavation subgrade and crushed stone backfill may also be required. We recommend that a geosynthetic used for stabilization consist of a non-woven geosynthetic with an AOS of #70 to #100 sieve, and a minimum puncture resistance of at least 950 pounds (such as Mirafi FW700 or equivalent).

Soils containing more than trace amounts of silt are susceptible to softening and disturbance by construction activity during wet or freezing weather. Subgrade protection should be the responsibility of the contractor and special precautions and protective measures appropriate for the weather conditions during construction should be used during earthwork and construction to preserve the integrity of subgrade. Construction traffic should not operate directly on prepared subgrades.

If foundation construction occurs during freezing conditions, insulating blankets, heaters, or other suitable measures should be employed to prevent foundation subgrades from freezing until the foundations are backfilled sufficiently to prevent frost from reaching the footing subgrades and penetrating beneath foundation elements.

Slopes

Permanent fill slopes should be formed at 3H:1V or flatter. The face of fill slopes should be overbuilt and cut back into compacted materials with a smooth excavator bucket. If steeper fill slopes are desired, we should be consulted to evaluate use of grid reinforcement or rock blankets.

Fill

Structural Fill should meet the requirements of material specification M1.03.0-type B Gravel Borrow or M2.01.7 Dense-graded Crushed Stone for Subbase in the latest edition of the Massachusetts DOT Standard Specifications for Highways and Bridges. Structural Fill should be used to replace unsuitable soils and as backfill around and above footings.

Crushed stone may be used in place of structural fill as approved by the Engineer. Crushed Stone shall consist of durable crushed rock or durable crushed gravel stone, free from ice and snow, sand, clay, loam, or other deleterious or organic material. The crushed stone shall be uniformly blended and shall conform to the requirements provided in MassDOT Standard Specifications section M2.01.0. Where crushed stone is placed, the material should be fully encased in a woven geotextile, such as Mirafi FW700 or equivalent, and compacted until dense and well-keyed.

Common Fill used to construct the proposed berms along the western edge of the site should meet the requirements of material specification M1.01.0 Ordinary Borrow in the latest edition of the Massachusetts DOT Standard Specifications for Highways and Bridges.

On-site soils are not expected to be suitable for re-use due to the presence of debris and environmental contaminants.

Structural fill should be placed in 10-inch thick maximum loose lifts with each lift compacted to at least 95 percent of the materials maximum dry density as determined by ASTM D1557. In confined areas and where only hand-guided compaction equipment can be used, the lift thickness should be reduced to not more than 6-inches and the maximum particle size reduced to two inches.

LIMITATIONS

We have prepared this report for use by the City of Boston Parks and Recreation Department and members of the design and construction team for the subject project and this site only. The data and report can be used for estimating purposes, but our report, conclusions, and interpretations should not be construed as a warranty of the subsurface conditions and are not applicable to other sites. Additional information about interpretation and use of this report is included in *Attachment D*.

Soil borings and test pits indicate soil conditions only at specific locations and only to the depths penetrated. They do not necessarily reflect subsurface conditions that may exist between exploration locations. If subsurface conditions differing from those described are noted during the course of excavation and construction, reevaluation will be necessary.

Site development plans and design details were considered preliminary at the time this report was prepared. If changes are made in site grades, configuration, design loads, or type of construction, the conclusions and recommendations presented herein may not be applicable. We should be

consulted to review final design drawings and specifications to see that our recommendations are suitably followed. If design changes are made, we should be retained to review our conclusions and recommendations and provide a written evaluation or modification. Additional geotechnical engineering analyses and explorations may be necessary.

The recommendations in this report are preliminary as actual subsurface conditions may differ from those interpreted based on our subsurface explorations. For our recommendations to be considered final, we must be retained to observe the actual subsurface conditions encountered during construction. Our observations will allow us to interpret the actual conditions present during construction and adapt our recommendations if needed.

Within the limitations of scope, schedule, and budget, our services have been executed in accordance with generally accepted practices in this area at the time this report was prepared. No warranty or other conditions, expressed or implied, is given.

It has been a pleasure assisting you with this project and we look forward to our continued involvement. Please call if you have any questions.

Sincerely,
WESTON & SAMPSON ENGINEERS, INC.



Matthew J. Zanchi, EIT
Project Engineer



Joseph P. Laird, PE¹
Senior Project Manager

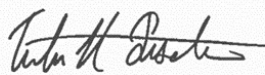

Tulin H. Fuselier, PE
Geotechnical Practice Leader

¹ Registered in PA, NJ, RI, WV, OH, TX and NM

Attachments:

Figure 1 – Proposed Site Plan

Figure 2 – Grading Plan

Attachment A – Boring Logs (17 pages)

Attachment B – Test Pit Logs (5 pages)

Attachment C – Geotechnical Laboratory Test Results (4 pages)

Attachment D – Important Information about This Geotechnical-Engineering Report

MJZ:JPL:THF

P:\MA\Boston MA\McConnell Playground\Geotechnical\Report\Geotech Letter Report - Boston McConnell Park Rev 0.doc

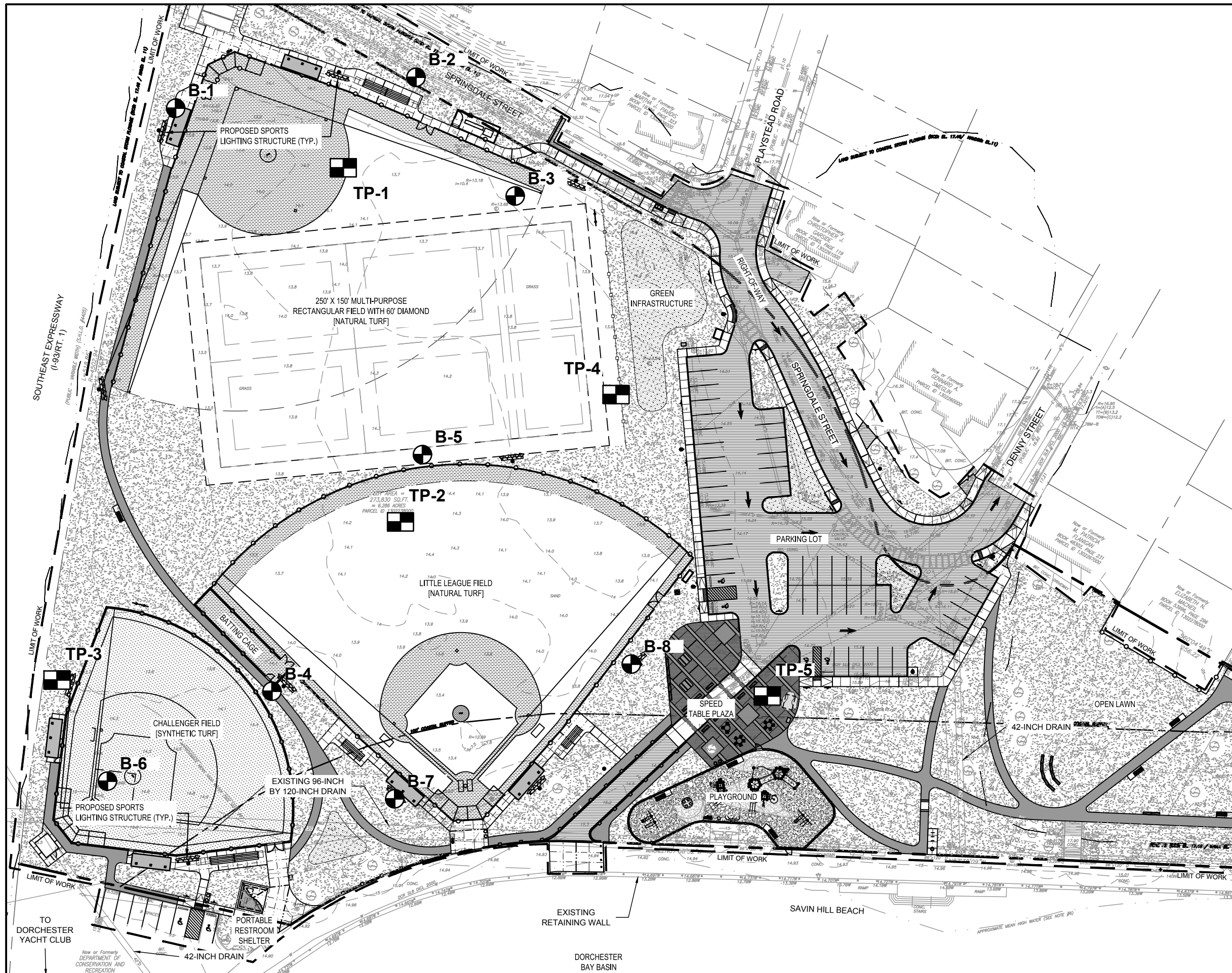

FIGURES



NOTES:

1. THIS FIGURE IS BASED ON 90% PROGRESS - CONSTRUCTION DRAWINGS PREPARED BY WESTON & SAMPSON ENGINEERS, INC. DATED MAY 29, 2020.
2. ELEVATIONS REFERENCE THE BOSTON CITY BASE (BCB).
3. B-1 THROUGH B-8 COMPLETED BY TECHNICAL DRILLING SERVICES OF STERLING, MA AND OBSERVED BY WESTON & SAMPSON ENGINEERS, INC. BETWEEN JUNE 15 AND 18, 2020.
4. TP-1 THROUGH TP-5 COMPLETED BY TECHNICAL DRILLING SERVICES OF STERLING, MA AND OBSERVED BY WESTON & SAMPSON ENGINEERS, INC. ON JUNE 17, 2020.
5. EXPLORATION LOCATIONS SHOWN ARE BASED ON FIELD MEASUREMENTS RELATIVE TO EXISTING SITE FEATURES.

LEGEND:

-  **B-1** BORING DESIGNATION AND APPROXIMATE LOCATION.
-  **TP-1** TEST PIT DESIGNATION AND APPROXIMATE LOCATION.

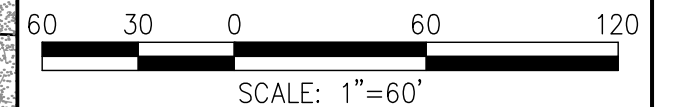

**FIGURE 1
PROPOSED SITE PLAN**

IMPROVEMENTS TO
MCCONNELL PARK
BOSTON, MA

DESIGNED BY: MJZ | CHECKED BY: JPL | JULY 2020







NOTES:

1. THIS FIGURE IS BASED ON 90% PROGRESS - CONSTRUCTION DRAWINGS PREPARED BY WESTON & SAMPSON ENGINEERS, INC. DATED MAY 29, 2020.
2. ELEVATIONS REFERENCE THE BOSTON CITY BASE (BCB).
3. B-1 THROUGH B-8 COMPLETED BY TECHNICAL DRILLING SERVICES OF STERLING, MA AND OBSERVED BY WESTON & SAMPSON ENGINEERS, INC. BETWEEN JUNE 15 AND 18, 2020.
4. TP-1 THROUGH TP-5 COMPLETED BY TECHNICAL DRILLING SERVICES OF STERLING, MA AND OBSERVED BY WESTON & SAMPSON ENGINEERS, INC. ON JUNE 17, 2020.
5. EXPLORATION LOCATIONS SHOWN ARE BASED ON FIELD MEASUREMENTS RELATIVE TO EXISTING SITE FEATURES.

LEGEND:

-  **B-1** BORING DESIGNATION AND APPROXIMATE LOCATION.
-  **TP-1** TEST PIT DESIGNATION AND APPROXIMATE LOCATION.

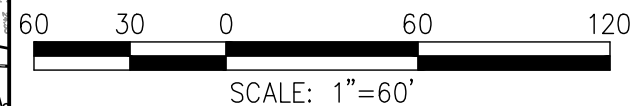

**FIGURE 2
GRADING PLAN**

IMPROVEMENTS TO
MCCONNELL PARK
BOSTON, MA

DESIGNED BY: MJZ | CHECKED BY: JPL | JULY 2020

Weston & SampsonSM



ATTACHMENT A

Boring Logs

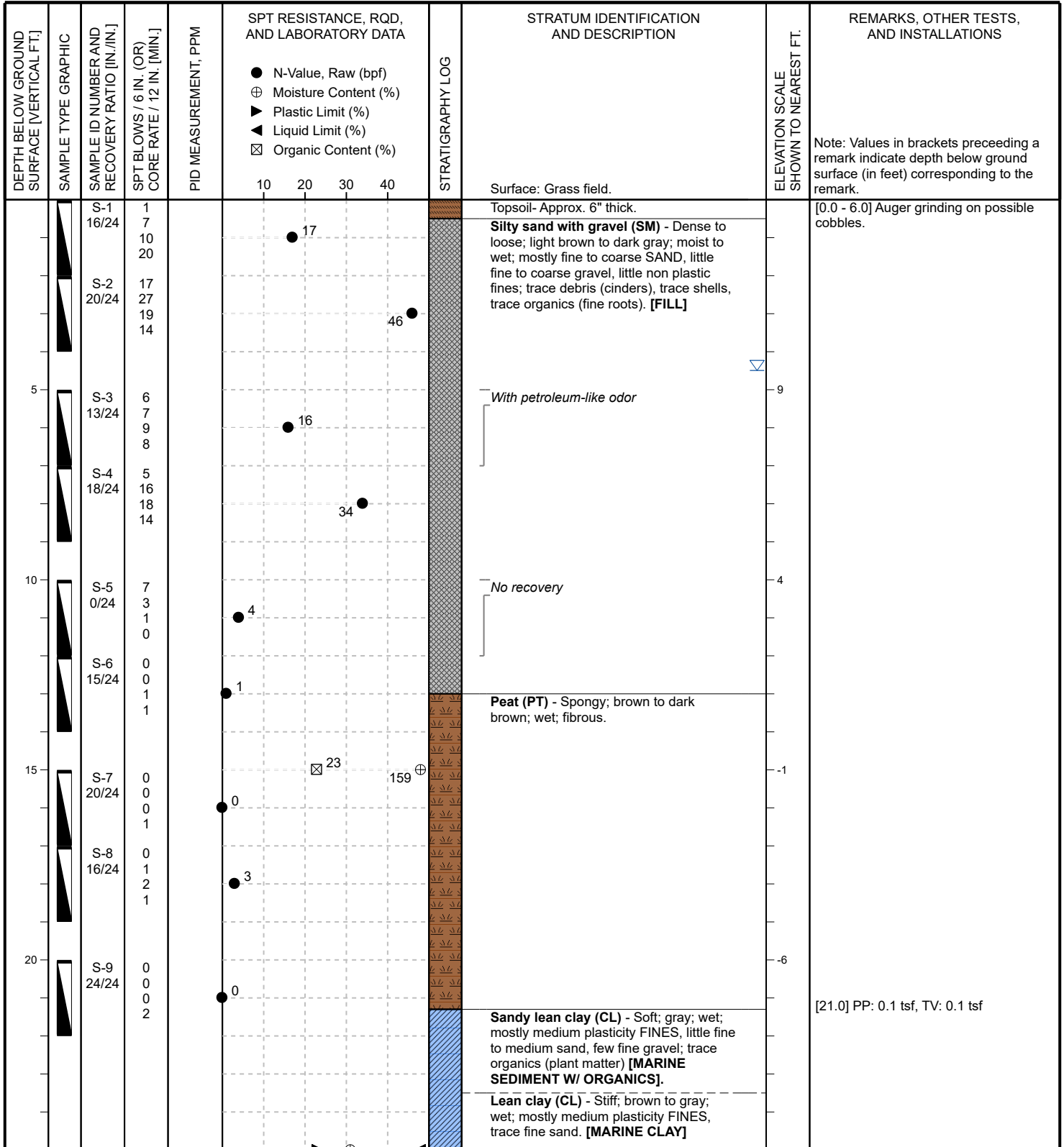
CONTRACTOR: Technical Drilling Services, Inc.	BORING LOCATION: See site plan	DATE START: June 15, 2020
FOREMAN: M. Kelly	ADVANCE METHOD: Hollow-Stem Auger Drilling	DATE FINISH: June 15, 2020
LOGGED BY: B. Goffin, EIT	AUGER DIAMETER: 4-1/4" ID (Stem), 7-5/8" OD (Flights)	GROUND EL: 14.0 ± (Boston City Base)
CHECKED BY: M. Zanchi, EIT	SUPPORT CASING: N/A	FINAL DEPTH: 27.0 ft.
EQUIPMENT: Geoprobe 7822	CORING METHOD: N/A	GRID COORDS: N/A
SPT HAMMER: Automatic (140-lb.)	BACKFILL MATERIAL: Drill Cuttings	GRID SYSTEM: N/A



Refer to the attached index sheets for important information about this log including general notes, legends, and guidance on description methods and procedures.

DEPTH BELOW GROUND SURFACE [VERTICAL FT.]	SAMPLE TYPE GRAPHIC	SAMPLE ID NUMBER AND RECOVERY RATIO [IN./IN.]	SPT BLOWS / 6 IN. (OR) CORE RATE / 12 IN. [MIN.]	PID MEASUREMENT, PPM	SPT RESISTANCE, RQD, AND LABORATORY DATA ● N-Value, Raw (bpf) ⊕ Moisture Content (%) ▼ Plastic Limit (%) ▲ Liquid Limit (%) ☒ Organic Content (%)	STRATIGRAPHY LOG	STRATUM IDENTIFICATION AND DESCRIPTION	ELEVATION SCALE SHOWN TO NEAREST FT.	REMARKS, OTHER TESTS, AND INSTALLATIONS
		S-10 24/24	0 3 6 7		● 9				[25.0] PP: 3.5 tsf, TV: 0.5 tsf
30								-16	
35								-21	
40								-26	
45								-31	
50								-36	
									Exploration ended at 27.0 ft.

CONTRACTOR: Technical Drilling Services, Inc.	BORING LOCATION: See site plan	DATE START: June 18, 2020
FOREMAN: M. Kelly	ADVANCE METHOD: Rotary Wash Drilling	DATE FINISH: June 18, 2020
LOGGED BY: S. Wuebbolt, EIT	AUGER DIAMETER: N/A	GROUND EL: 15.0 ± (Boston City Base)
CHECKED BY: M. Zanchi, EIT	SUPPORT CASING: Driven Flush-Joint Casing (4" ID)	FINAL DEPTH: 18.3 ft. (Refusal)
EQUIPMENT: Geoprobe 7822	CORING METHOD: N/A	GRID COORDS: N/A
SPT HAMMER: Automatic (140-lb.)	BACKFILL MATERIAL: Drill Cuttings	GRID SYSTEM: N/A

DEPTH BELOW GROUND SURFACE [VERTICAL FT.]	SAMPLE TYPE GRAPHIC	SAMPLE ID NUMBER AND RECOVERY RATIO [IN./IN.]	SPT BLOWS / 6 IN. (OR) CORE RATE / 12 IN. [MIN.]	PID MEASUREMENT, PPM	SPT RESISTANCE, RQD, AND LABORATORY DATA		STRATIGRAPHY LOG	STRATUM IDENTIFICATION AND DESCRIPTION	ELEVATION SCALE SHOWN TO NEAREST FT.	REMARKS, OTHER TESTS, AND INSTALLATIONS
					● N-Value, Raw (bpf)	⊕ Moisture Content (%)				
0					10 20 30 40			Surface: Grass field.		
0.2		S-1 17/24	6 20 18 15	0.2		38		Topsoil- Approx. 7" thick.		
6.3		S-2 15/24	15 10 9 13	6.3		19		Silty sand with gravel (SM) - Dense to medium dense; dark brown to gray; moist to wet; mostly fine to coarse SAND, some non plastic fines, little fine to coarse gravel; petroleum-like odor; trace debris (cinders, wood), trace organics (plant matter). [FILL]		[1.0 - 14.0] Intermittent roller bit grinding on possible cobbles.
110.0				110.0				2" piece of wood/lumber with creosote-like odor in sampler		
								Slag and glass fragments observed in wash fluid		
0.4		S-3 11/24	1 4 2 2	0.4		6		Silty gravel with sand (GM) - Loose; gray; wet; some fine to coarse GRAVEL, some non plastic fines, little fine to medium sand; occasional debris (concrete, wood). [FILL]		
								Wood fragments observed in wash fluid		
0.3		S-4 13/24	27 39 36 42	0.3		>> 75		Well graded sand with silt and gravel (SW-SM) - Dense to very dense; brown; wet; mostly fine to coarse SAND, some fine to coarse gravel, few non plastic fines. [GLACIAL TILL]		[15.9 - 17.0] Roller bit grinding and slow drilling on possible boulder.
		S-5 6/8	80 100/2							Sampler and casing refusal at 18.3 ft. (exploration ended).

CONTRACTOR: Technical Drilling Services, Inc.	BORING LOCATION: See site plan	DATE START: June 17, 2020
FOREMAN: M. Kelly	ADVANCE METHOD: Rotary Wash Drilling	DATE FINISH: June 17, 2020
LOGGED BY: B. Goffin, EIT	AUGER DIAMETER: N/A	GROUND EL: 14.0 ± (Boston City Base)
CHECKED BY: M. Zanchi, EIT	SUPPORT CASING: Driven Flush-Joint Casing (4" ID)	FINAL DEPTH: 22.0 ft.
EQUIPMENT: Geoprobe 7822	CORING METHOD: N/A	GRID COORDS: N/A
SPT HAMMER: Automatic (140-lb.)	BACKFILL MATERIAL: Drill Cuttings	GRID SYSTEM: N/A

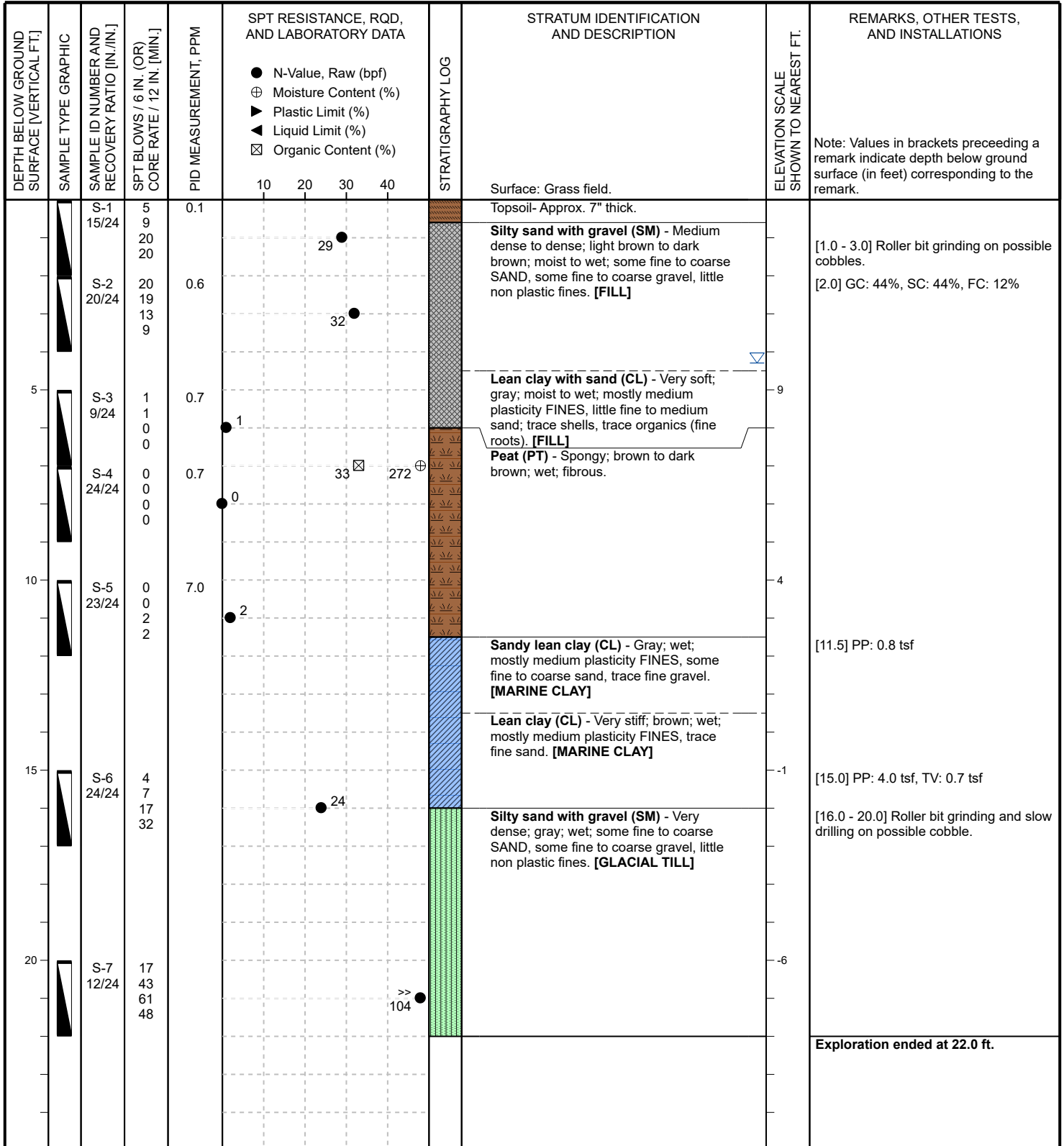

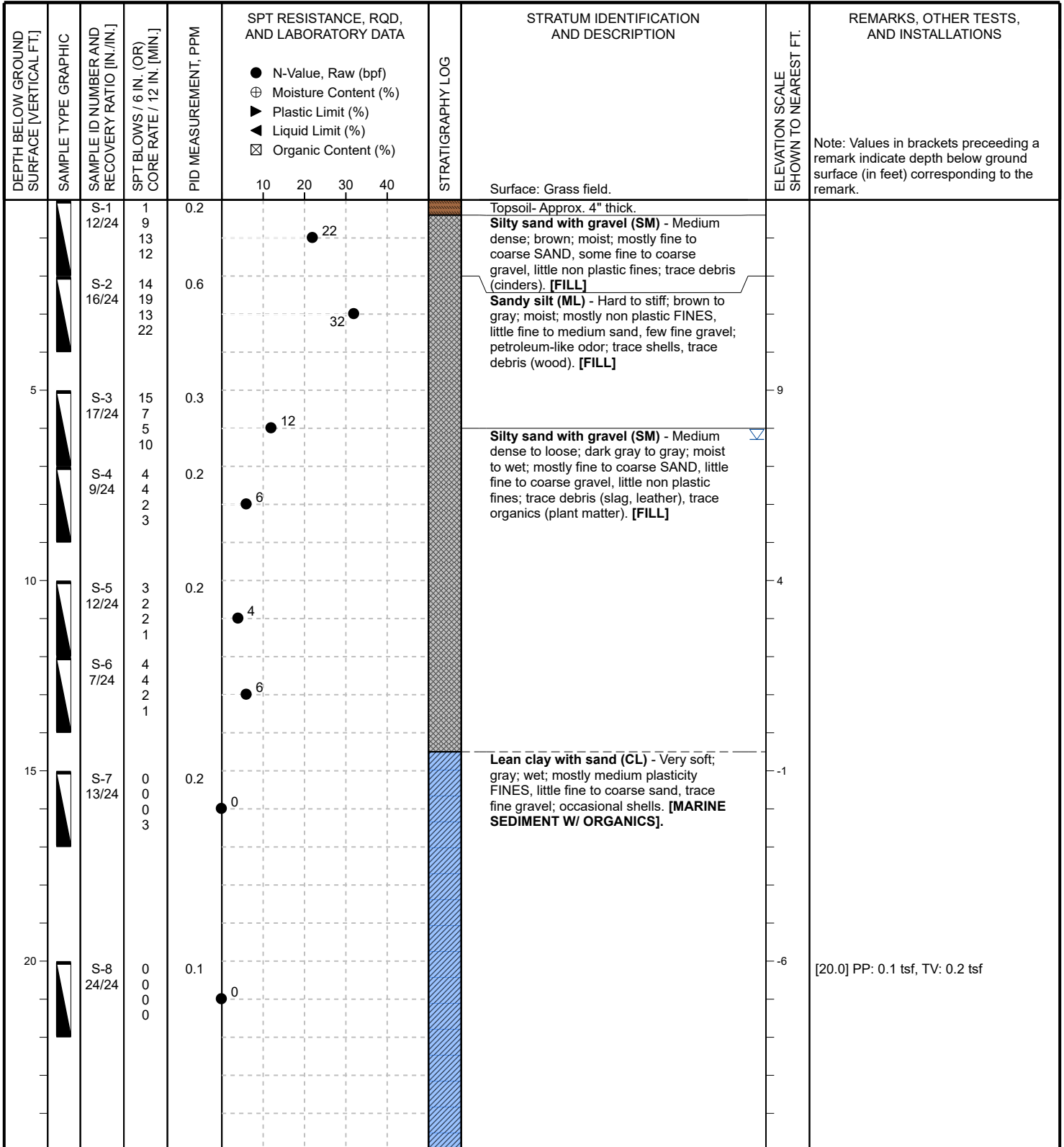

CONTRACTOR: Technical Drilling Services, Inc.	BORING LOCATION: See site plan	DATE START: June 16, 2020
FOREMAN: M. Kelly	ADVANCE METHOD: Rotary Wash Drilling	DATE FINISH: June 17, 2020
LOGGED BY: S. Wuebbolt, EIT	AUGER DIAMETER: N/A	GROUND EL: 14.0 ± (Boston City Base)
CHECKED BY: M. Zanchi, EIT	SUPPORT CASING: Driven Flush-Joint Casing (4" ID)	FINAL DEPTH: 42.0 ft.
EQUIPMENT: Geoprobe 7822	CORING METHOD: N/A	GRID COORDS: N/A
SPT HAMMER: Automatic (140-lb.)	BACKFILL MATERIAL: Drill Cuttings	GRID SYSTEM: N/A



DEPTH BELOW GROUND SURFACE [VERTICAL FT.]	SAMPLE TYPE GRAPHIC	SAMPLE ID NUMBER AND RECOVERY RATIO [IN./IN.]	SPT BLOWS / 6 IN. (OR) CORE RATE / 12 IN. [MIN.]	PID MEASUREMENT, PPM	SPT RESISTANCE, RQD, AND LABORATORY DATA	STRATIGRAPHY LOG	STRATUM IDENTIFICATION AND DESCRIPTION	ELEVATION SCALE SHOWN TO NEAREST FT.	REMARKS, OTHER TESTS, AND INSTALLATIONS
		S-9 24/24	0 0 0 0	0.2	● 0				[25.0] PP: 0.1 tsf, TV: 0.2 tsf
30		S-10 24/24	0 0 1 3	0.1	● 1		Peat (PT) - Spongy; brown; wet; [MARINE SEDIMENT W/ ORGANICS]. <i>Organic cuttings observed in wash fluid</i>	-16	
35		S-11 22/24	5 10 18 20		● 28		Lean clay (CL) - Very stiff to stiff; gray to brown; wet; mostly medium plasticity FINES, trace fine sand, trace fine gravel. [MARINE CLAY]	-21	[35.0] PP: 4.5 tsf, TV: 0.8 tsf
40		S-12 24/24	3 4 6 7		● 10			-26	[40.0] PP: 2.0 tsf, TV: 0.4 tsf
45								-31	
50								-36	
									Exploration ended at 42.0 ft.

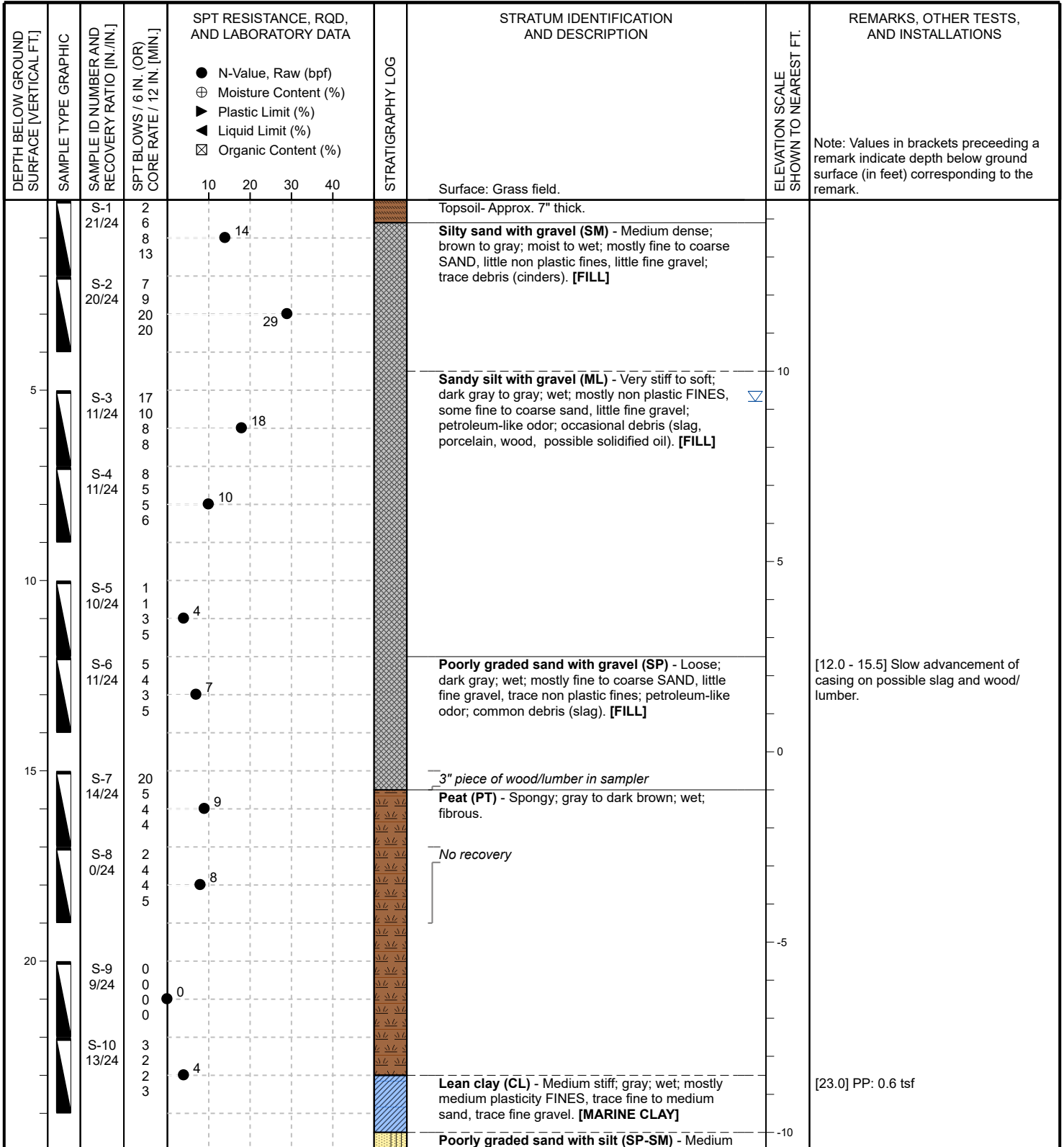

CONTRACTOR: Technical Drilling Services, Inc.	BORING LOCATION: See site plan	DATE START: June 15, 2020
FOREMAN: M. Kelly	ADVANCE METHOD: Rotary Wash Drilling	DATE FINISH: June 15, 2020
LOGGED BY: B. Goffin, EIT	AUGER DIAMETER: N/A	GROUND EL: 14.5 ± (Boston City Base)
CHECKED BY: M. Zanchi, EIT	SUPPORT CASING: Driven Flush-Joint Casing (4" ID)	FINAL DEPTH: 27.0 ft.
EQUIPMENT: Geoprobe 7822	CORING METHOD: N/A	GRID COORDS: N/A
SPT HAMMER: Automatic (140-lb.)	BACKFILL MATERIAL: Drill Cuttings	GRID SYSTEM: N/A

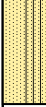

DEPTH BELOW GROUND SURFACE [VERTICAL FT.]	SAMPLE TYPE GRAPHIC	SAMPLE ID NUMBER AND RECOVERY RATIO [IN./IN.]	SPT BLOWS / 6 IN. (OR) CORE RATE / 12 IN. [MIN.]	SPT RESISTANCE, RQD, AND LABORATORY DATA ● N-Value, Raw (bpf) ⊕ Moisture Content (%) ▼ Plastic Limit (%) ▲ Liquid Limit (%) ☒ Organic Content (%)	STRATIGRAPHY LOG	STRATUM IDENTIFICATION AND DESCRIPTION	ELEVATION SCALE SHOWN TO NEAREST FT.	REMARKS, OTHER TESTS, AND INSTALLATIONS
		S-11 11/24	7 7 4 5	● 11		dense; gray; wet; mostly fine to medium SAND, few non plastic fines; [MARINE SAND] .		Note: Values in brackets preceding a remark indicate depth below ground surface (in feet) corresponding to the remark.
30							-15	
35							-20	
40							-25	
45							-30	
50							-35	
								Exploration ended at 27.0 ft.

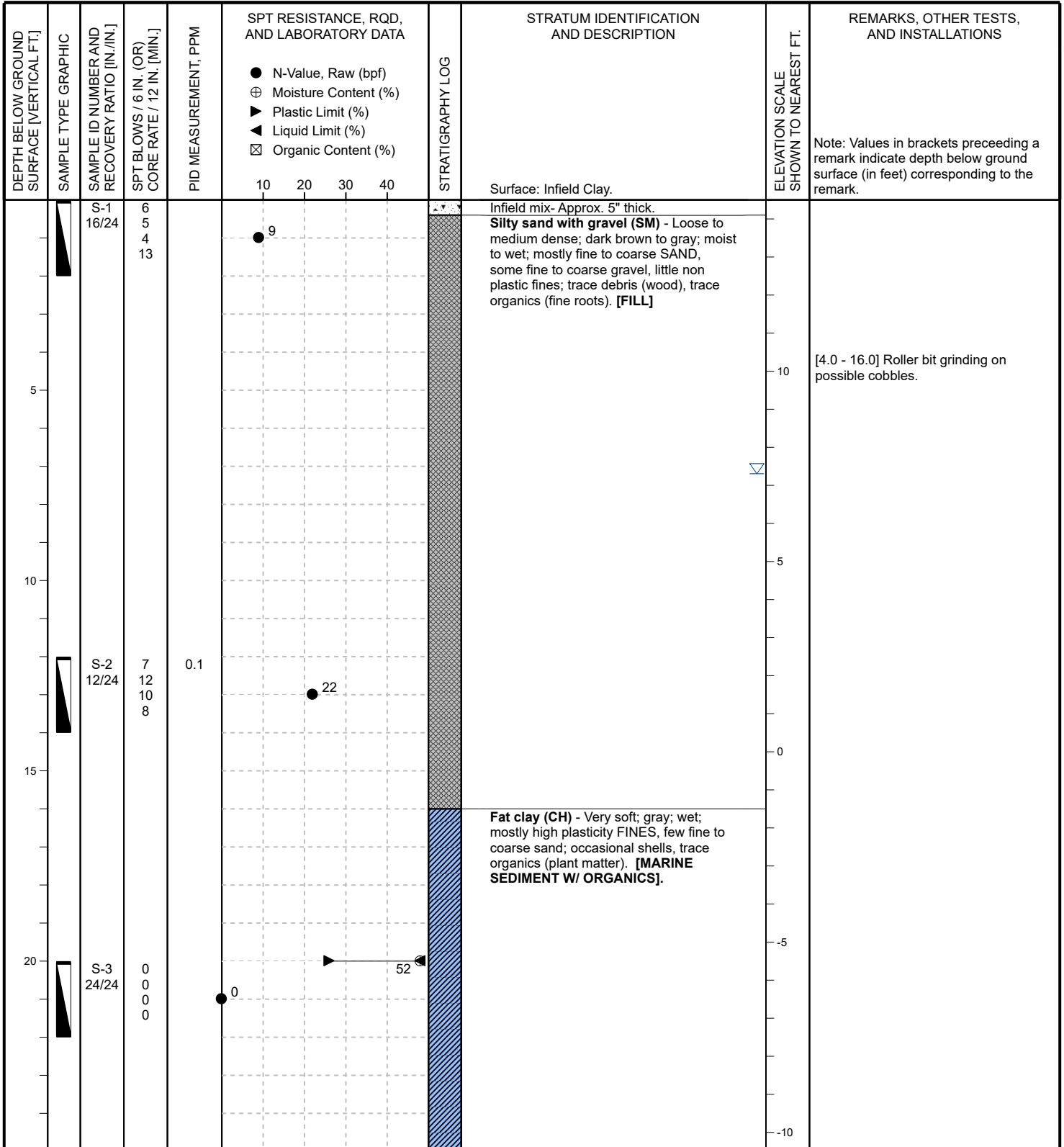

CONTRACTOR: Technical Drilling Services, Inc.	BORING LOCATION: See site plan	DATE START: June 18, 2020
FOREMAN: M. Kelly	ADVANCE METHOD: Rotary Wash Drilling	DATE FINISH: June 18, 2020
LOGGED BY: S. Wuebbolt, EIT	AUGER DIAMETER: N/A	GROUND EL: 14.5 ± (Boston City Base)
CHECKED BY: M. Zanchi, EIT	SUPPORT CASING: Driven Flush-Joint Casing (4" ID)	FINAL DEPTH: 42.0 ft.
EQUIPMENT: Geoprobe 7822	CORING METHOD: N/A	GRID COORDS: N/A
SPT HAMMER: Automatic (140-lb.)	BACKFILL MATERIAL: Drill Cuttings	GRID SYSTEM: N/A



DEPTH BELOW GROUND SURFACE [VERTICAL FT.]	SAMPLE TYPE GRAPHIC	SAMPLE ID NUMBER AND RECOVERY RATIO [IN./IN.]	SPT BLOWS / 6 IN. (OR) CORE RATE / 12 IN. [MIN.]	PID MEASUREMENT, PPM	SPT RESISTANCE, RQD, AND LABORATORY DATA ● N-Value, Raw (bpf) ⊕ Moisture Content (%) ▼ Plastic Limit (%) ▲ Liquid Limit (%) ☒ Organic Content (%)	STRATIGRAPHY LOG	STRATUM IDENTIFICATION AND DESCRIPTION	ELEVATION SCALE SHOWN TO NEAREST FT.	REMARKS, OTHER TESTS, AND INSTALLATIONS Note: Values in brackets preceding a remark indicate depth below ground surface (in feet) corresponding to the remark.
30		S-4 24/24	0 0 0 0	0.3	● 0	STRATIGRAPHY LOG		-15	
35		S-5 24/24	0 0 0 0	0.1	● 0			-20	[35.0] PP: 0.2 tsf, TV: 0.1 tsf
40		S-6 24/24	4 8 11 14	0.2	● 19		Lean clay (CL) - Very stiff; gray to brown; wet; mostly medium plasticity FINES, trace fine sand. [MARINE CLAY]	-25	[38.0] Change in drilling rate. [40.0] PP: 3.0 tsf, TV: 0.4 tsf
45								-30	
50								-35	
									Exploration ended at 42.0 ft.

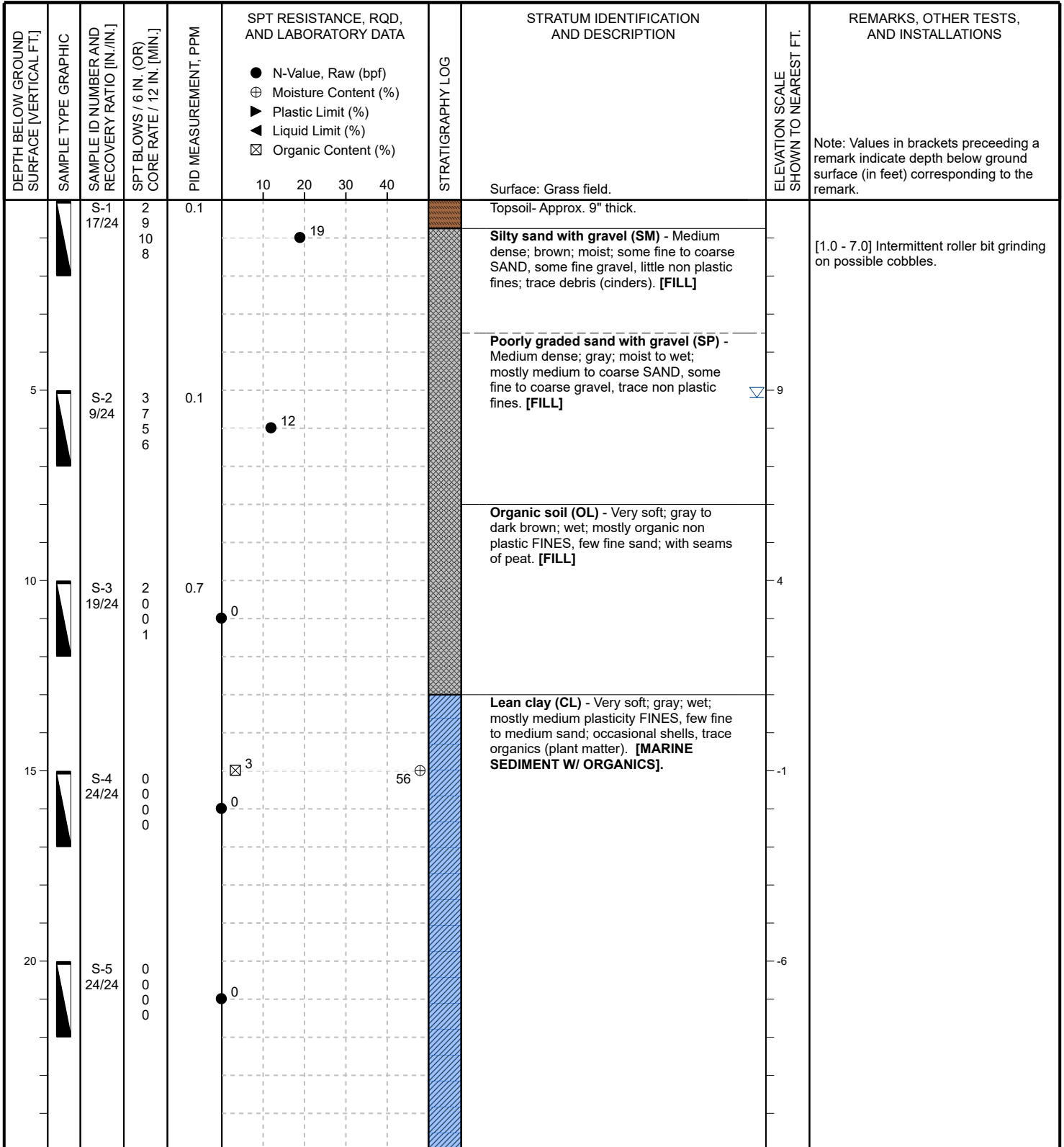

CONTRACTOR: Technical Drilling Services, Inc.	BORING LOCATION: See site plan	DATE START: June 17, 2020
FOREMAN: M. Kelly	ADVANCE METHOD: Rotary Wash Drilling	DATE FINISH: June 18, 2020
LOGGED BY: B. Goffin, EIT	AUGER DIAMETER: N/A	GROUND EL: 14.0 ± (Boston City Base)
CHECKED BY: M. Zanchi, EIT	SUPPORT CASING: Driven Flush-Joint Casing (4" ID)	FINAL DEPTH: 42.0 ft.
EQUIPMENT: Geoprobe 7822	CORING METHOD: N/A	GRID COORDS: N/A
SPT HAMMER: Automatic (140-lb.)	BACKFILL MATERIAL: Drill Cuttings	GRID SYSTEM: N/A

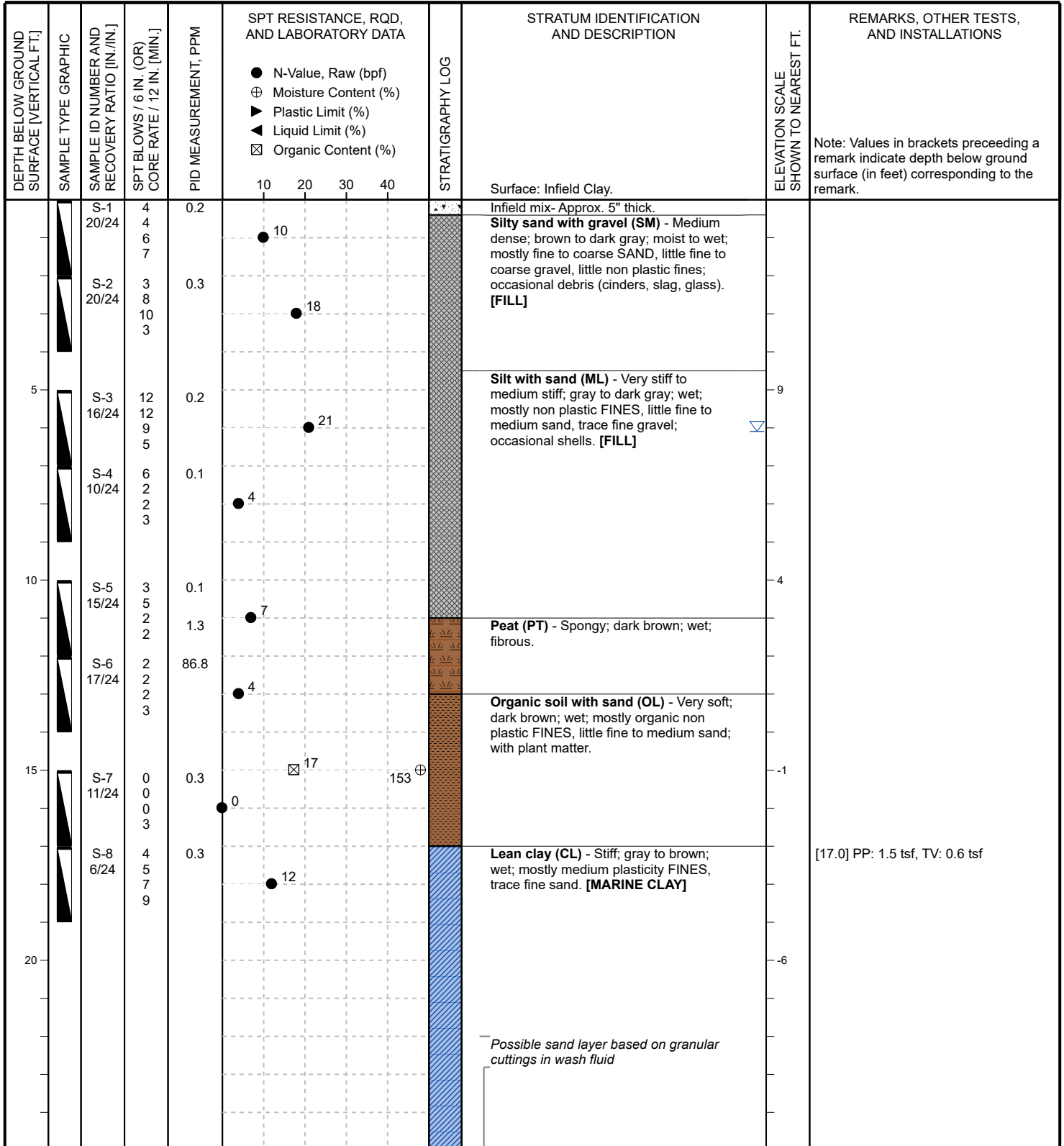

DEPTH BELOW GROUND SURFACE [VERTICAL FT.]	SAMPLE TYPE GRAPHIC	SAMPLE ID NUMBER AND RECOVERY RATIO [IN./IN.]	SPT BLOWS / 6 IN. (OR) CORE RATE / 12 IN. [MIN.]	PID MEASUREMENT, PPM	SPT RESISTANCE, RQD, AND LABORATORY DATA ● N-Value, Raw (bpf) ⊕ Moisture Content (%) ▼ Plastic Limit (%) ▲ Liquid Limit (%) ☒ Organic Content (%)	STRATIGRAPHY LOG	STRATUM IDENTIFICATION AND DESCRIPTION	ELEVATION SCALE SHOWN TO NEAREST FT.	REMARKS, OTHER TESTS, AND INSTALLATIONS
					10 20 30 40				
							Organic cuttings observed in wash fluid		
30		S-6 0/24	4 6 5 6		● 11		Lean clay (CL) - Stiff; gray to brown; wet; mostly medium plasticity FINES, trace fine sand. [MARINE CLAY] No recovery	-16	
35		S-7 21/24	4 1 5 6		● 6		Silty sand (SM) - Loose; brown; wet; mostly fine to medium SAND, little non plastic fines; [MARINE SAND]. Granular cuttings observed in wash fluid	-21	
40		S-8 23/24	2 1 3 2		● 4		Lean clay (CL) - Medium stiff; gray; wet; mostly medium plasticity FINES, few fine to medium sand. [MARINE CLAY]	-26	[40.0] PP: 1.2 tsf, TV: 0.3 tsf
45								-31	Exploration ended at 42.0 ft.
50								-36	

CONTRACTOR: Technical Drilling Services, Inc.	BORING LOCATION: See site plan	DATE START: June 16, 2020
FOREMAN: M. Kelly	ADVANCE METHOD: Rotary Wash Drilling	DATE FINISH: June 16, 2020
LOGGED BY: S. Wuebbolt, EIT	AUGER DIAMETER: N/A	GROUND EL: 14.0 ± (Boston City Base)
CHECKED BY: M. Zanchi, EIT	SUPPORT CASING: Driven Flush-Joint Casing (4" ID)	FINAL DEPTH: 27.0 ft.
EQUIPMENT: Geoprobe 7822	CORING METHOD: N/A	GRID COORDS: N/A
SPT HAMMER: Automatic (140-lb.)	BACKFILL MATERIAL: Drill Cuttings	GRID SYSTEM: N/A



DEPTH BELOW GROUND SURFACE [VERTICAL FT.]	SAMPLE TYPE GRAPHIC	SAMPLE ID NUMBER AND RECOVERY RATIO [IN./IN.]	SPT BLOWS / 6 IN. (OR) CORE RATE / 12 IN. [MIN.]	PID MEASUREMENT, PPM	SPT RESISTANCE, RQD, AND LABORATORY DATA ● N-Value, Raw (bpf) ⊕ Moisture Content (%) ▼ Plastic Limit (%) ▲ Liquid Limit (%) ☒ Organic Content (%)	STRATIGRAPHY LOG	STRATUM IDENTIFICATION AND DESCRIPTION	ELEVATION SCALE SHOWN TO NEAREST FT.	REMARKS, OTHER TESTS, AND INSTALLATIONS
		S-9 23/24	5 5 6 8		● 11				[25.0] PP: 2.5 tsf, TV: 0.4 tsf
30								-16	
35								-21	
40								-26	
45								-31	
50								-36	
									Exploration ended at 27.0 ft.

GUIDE TO SUBSURFACE EXPLORATION LOGS



INDEX SHEET 1 GENERAL INFORMATION

GENERAL NOTES AND USE OF LOGS

- 1.) Explorations were made by ordinary and conventional methods and with care adequate for Weston & Sampson's study and/or design purposes. The exploration logs are part of a specific report prepared by Weston & Sampson for the referenced project and client, and are an integral part of that report. Information and interpretations are subject to the explanations and limitations stated in the report. Weston & Sampson is not responsible for any interpretations, assumptions, projections, or interpolations made by others.
- 2.) Exploration logs represent general conditions observed at the point of exploration on the date(s) stated. Boundary lines separating soil and rock layers (strata) represent approximate boundaries only and are shown as solid lines where observed and dashed lines where inferred based on drilling action. Actual transitions may be gradual and changes may occur over time.
- 3.) Soil and rock descriptions are based on visual-manual examination of recovered samples, direct observation in test pits (when permissible), and laboratory testing (when conducted).
- 4.) Water level observations were made at the times and under the conditions stated. Fluctuations should be expected to vary with seasons and other factors. Use of fluids during drilling may affect water level observations. The absence of water level observations does not necessarily mean the exploration was dry or that subsurface water will not be encountered during construction.
- 5.) Standard split spoon samplers may not recover particles with any dimension larger than 1-3/8 inches. Reported gravel conditions or poor sample recovery may not reflect actual in-situ conditions.
- 6.) Sections of this guide provide a general overview of Weston & Sampson's practices and procedures for *identifying* and *describing* soil and rock. These procedures are predominantly based on ASTM D2488, *Standard Practice for Description and Identification of Soils (Visual-Manual Procedures)*, the International Society of Rock Mechanics (ISRM) standards, and the *Engineering Geology Field Manual* published by the Bureau of Reclamation. Not all aspects of this guide relating to description and identification procedures of soil and rock may be applicable in all circumstances.

SAMPLER GRAPHICS

- Split Spoon (Standard)
2" OD, 1-3/8" ID
- Split Spoon (Oversize)
3" OD, 2-3/8" ID
- Shelby or Piston Tube
3" OD, 2-7/8" ID
- Double-Tube Rock Core Barrel
2" Core Diameter
- Direct Push with Acetate Liner
Various Liner Sizes
- Auger Sample
(from cuttings or hand auger)
- Grab Sample
(manual, from discrete point)
- Composite Sample
(multiple grab samples)

WELL GRAPHICS

- Cement concrete seal around casing or riser pipe
- Bentonite seal around casing or riser pipe
- Cement grout seal around casing or riser pipe
- Soil backfill around riser pipe or beneath screen
- Gravel backfill around screen or riser pipe
- Sand backfill around screen or riser pipe (filter sand)
- Solid-wall riser; Sch. 40 PVC, 1" ID unless noted otherwise
- Slotted screen; Sch. 40 PVC, 1" ID with machined slots

CAVING / SEEPAGE TERMS

The following caving and/or seepage terms may appear on a test pit log.

Caving Term	Criteria
Minor.....	less than 1 cubic ft.
Moderate.....	1 to 3 cubic ft.
Severe.....	greater than 3 cubic ft.

Seepage Term	Criteria
Slow.....	less than 1 gpm
Moderate.....	1 to 3 gpm
Fast.....	greater than 3 gpm

KEY TO WATER LEVELS

- Observed in exploration during advancement.
- Measured in exploration at completion, prior to backfilling or well installation.
- Measured in exploration after the stated stabilization period, prior to backfilling, or in well installation if noted.

DEFINITIONS OF COMMON TERMS

Sample Recovery Ratio - The length of material recovered in a drive or push type sampler over the length of sampler penetration, in inches (e.g. 18/24).

Standard Penetration Test (SPT) - An in-situ test where a standard split-spoon sampler is driven a distance of 12 or 18 inches (after an initial 6-inch seating interval) using a 140-lb. hammer falling 30 inches for each blow.

SPT Blows - The number of hammer blows required to drive a split-spoon sampler each consecutive 6-inch interval during a *Standard Penetration Test*. If no discernable advancement of a split spoon sampler is made after 50 consecutive hammer blows, 50/X indicates *sampler refusal* and is the number of blows required to drive the sampler X inches.

SPT N-Value (N) - The uncorrected blow count representation of a soil's penetration resistance over a 12-inch interval after an initial 6-in. seating interval, reported in blows per foot (bpf). The N-value is correlated to soil engineering properties.

Auger Refusal - No discernable advancement of the auger over a period of 5 minutes with full rig down pressure applied.

Casing Refusal (Driven) - Casing penetration of less than 6 inches after a minimum 50 blows of a drop hammer weighing 300 lbs. or a minimum 100 blows of a drop hammer weighing 140 lbs.

PID Measurement - A measurement (electronic reading) taken in the field using a photoionization detector (PID) to detect the presence of volatile organic compounds in a soil sample. Values are reported as benzene equivalent units in parts per million (ppm) unless noted otherwise.

Rock Quality Designation (RQD) - A qualitative index measure of the degree of jointing and fracture of a rock core taken from a borehole. The RQD is defined as the sum length of solid core pieces 4 inches or longer divided by the run (cored) length, expressed as a percentage. Higher RQD values may indicate fewer joints and fractures in the rock mass.

Fill (Made Ground) - A deposit of soil and/or artificial waste materials that has been placed or altered by human processes.

LABORATORY TESTS AND FIELD MEASUREMENTS

MC.....	Moisture Content	IC.....	1D Incremental Consolidation
OC.....	Organic Content	VS.....	Laboratory Vane Shear
PL.....	Plastic Limit	US.....	Unconfined Compression
LL.....	Liquid Limit	TC.....	Triaxial Compression
GC.....	Gravel Content	PP.....	Pocket (Hand) Penetrometer
SC.....	Sand Content	TV.....	Torvane (Hand Vane)
FC.....	Fines Content	PID.....	Photoionization Detector
DS.....	Direct Shear	FID.....	Flame Ionization Detector

BORING ADVANCEMENT METHODS

Hollow-Stem Auger Drilling - Utilizes continuous flight auger sections with hollow stems to advance the borehole. Drill rods and a plug are inserted into the auger stem to prevent the entrance of soil cuttings into the augers.

Rotary Wash Drilling - Utilizes downward pressure and rotary action applied to a non-coring bit while washing the cuttings to the surface using a circulating fluid injected down the drill rods. The borehole is supported with either steel casing or the drilling fluid. Where a casing is used, the borehole is advanced sequentially by driving the casing to the desired depth and then cleaning out the casing. The process of driving and cleaning the casing is commonly referred to as the 'drive-and-wash' technique.

Continuous Sampling - Includes a variety of methods and procedures during which the borehole is advanced via continuous recovery of soil samples. *Direct Push* sampling is a common method that uses static downward pressure combined with percussive energy to drive a steel mandrel into the ground at continuous intervals while recovering soil samples in disposable acetate liners.

Rock Coring - Utilizes downward pressure and rotary action applied to a core barrel equipped with a diamond-set or tungsten carbide coring bit. During conventional coring, the entire barrel is retrieved from the hole upon completion of a core run. Wireline coring allows for removal of the inner barrel assembly containing the actual core while the drill rods and outer barrel remain in the hole. Various types and sizes of core barrels and bits are used.

GUIDE TO SUBSURFACE EXPLORATION LOGS



INDEX SHEET 2 SOIL DESCRIPTION

SOIL CONSTITUENTS

Naturally occurring soils consist of one or more of the following matrix constituents defined in terms of particle size.

Constituent	U.S. Sieve Size	Observed Size (in.)
Gravel (Coarse)	3/4 in. - 3 in.	3/4 - 3
Gravel (Fine)	No. 4 - 3/4 in.	1/5 - 3/4
Sand (Coarse)	No. 10 - No. 40	1/16 - 1/5
Sand (Medium)	No. 40 - No. 10	1/64 - 1/16
Sand (Fine)	No. 200 - No. 40	1/300 - 1/64
Fines (Silt or Clay)	Smaller than No. 200	Less than 1/300

SOIL IDENTIFICATION

Soil identification refers to the grouping of soils with similar physical characteristics into a category defined by a **group name** and corresponding **group symbol** based on estimation of the matrix soil constituents to the nearest 5% and simple manual tests. Proportions of cobbles, boulders, and other non-matrix soil materials are not considered during this procedure but are included in the overall soil description if observed or thought to be present. Refer to the following descriptions and tables adapted from ASTM D2488.

Coarse-Grained Soil - Coarse-grained soils contain fewer than 50% fines and are identified based on the following table.

Primary Constituent	Fines Percent	Type of Fines and Gradation	Group Symbol	Group Name ⁽¹⁾	
GRAVEL	≤ 5%	well graded	GW	Well graded gravel	
		poorly graded	GP	Poorly graded gravel	
	10%	clayey well graded	GW-GC	Well graded gravel with clay fines	
		poorly graded	GP-GC	Poorly graded gravel with clay fines	
% sand	10%	silty well graded	GW-GM	Well graded gravel with silt fines	
		poorly graded	GP-GM	Poorly graded gravel with silt fines	
SAND	15% to 45%	clay fines	GC	Clayey gravel	
		silt fines	GM	Silty gravel	
	≤ 5%	well graded	SW	Well graded sand	
		poorly graded	SP	Poorly graded sand	
	% sand	10%	clayey well graded	SW-SC	Well graded sand with clay fines
			poorly graded	SP-SC	Poorly graded sand with clay fines
% gravel	10%	silty well graded	SW-SM	Well graded sand with silt fines	
		poorly graded	SP-SM	Poorly graded sand with silt fines	
15% to 45%	clay fines	SC	Clayey sand		
	silt fines	SM	Silty sand		

⁽¹⁾ If soil is a gravel and contains 15% or more sand, add "with sand" to the group name. If soil is a sand and contains 15% of more gravel, add "with gravel" to the group name.

Inorganic Fine-Grained Soil - Fine-grained soils contain 50% or more fines and are identified based on the following table.

Plasticity Criteria	Dry Strength	Coarse Fraction S = Sand, G = Gravel	Group Symbol	Group Name ⁽¹⁾
Medium	Medium to high	< 15% S + G	CL	Lean clay
		≥ 30% % S ≥ % G	CL	Sandy lean clay
		S + G % S < % G	CL	Gravelly lean clay
Non-plastic	None to low	< 15% S + G	ML	Silt
		≥ 30% % S ≥ % G	ML	Sandy silt
		S + G % S < % G	ML	Gravelly silt
High	High to very high	< 15% S + G	CH	Fat clay
		≥ 30% % S ≥ % G	CH	Sandy fat clay
		S + G % S < % G	CH	Gravelly fat clay
Low to Medium	Low to medium	< 15% S + G	MH	Elastic silt
		≥ 30% % S ≥ % G	MH	Sandy elastic silt
		S + G % S < % G	MH	Gravelly elastic silt

⁽¹⁾ If soil contains 15% to 25% sand or gravel, add "with sand" or "with gravel" to the group name.

Organic Fine-Grained Soil - Fine-grained soils that contain enough organic particles to influence the soil properties are identified as Organic Soil and assigned the group symbol **OL** or **OH**.

Highly Organic Soil (Peat) - Soils composed primarily of plant remains in various stages of decomposition are identified as Peat and given the group symbol **PT**. Peat usually has an organic odor, a dark brown to black color, and a texture ranging from fibrous (original plant structure intact or mostly intact) to amorphous (plant structure decomposed to fine particles).

SOIL DESCRIPTION

Soils are described in the following general sequence. Deviations may occur in some instances.

Identification Components

(1) Group Name and Group Symbol

Description Components

- (2) Consistency (Fine-Grained) or Apparent Density (Coarse-Grained)
- (3) Color (*note, the term "to" may be used to indicate a gradational change*)
- (4) Soil Moisture
- (5) Matrix Soil Constituents (Gravel, Sand, Fines)
 - ↳ Proportion (*by weight*), particle size, plasticity of fines, angularity, etc.
- (6) Non-Matrix Soil Materials and Proportions (*by volume*)
- (7) Other Descriptive Information (Unusual Odor, Structure, Texture, etc.)
- (8) [Geologic Formation Name or Soil Survey Unit]

SPT N-VALUE CORRELATIONS

Consistency	SPT N-Value	Apparent Density	SPT N-Value
Very soft	0 - 2	Very loose	0 - 5
Soft	2 - 4	Loose	5 - 10
Medium stiff	4 - 8	Medium dense	10 - 30
Stiff	8 - 15	Dense	30 - 50
Very stiff	15 - 30	Very dense	> 50
Hard	> 30		

SOIL MOISTURE

Dry..... Apparent absence of moisture; dry to the touch.
Moist..... Damp but no visible water.
Wet..... Visible free water; saturated.

PROPORTIONS / PERCENTAGES

Proportions of gravel, sand, and fines (excluding cobbles, boulders, and other constituents) are stated in the following terms indicating a range of percentages **by weight** (to nearest 5%) of the minus 3-in. soil fraction and add up to 100%. Proportions of cobbles, boulders, and other non-matrix soil materials including artificial debris, roots, plant fibers, etc. are stated in the following terms indicating a range of percentages **by volume** (to the nearest 5%) of the total soil.

Mostly 50% - 100%	Numerous 40% - 50%
Some 30% - 45%	Common 25% - 35%
Little 15% - 25%	Occasional 10% - 20%
Few 5% - 10%	Trace Less than 5%
Trace Less than 5%	

PLASTICITY (FINES ONLY)

Non-plastic..... Dry specimen ball falls apart easily. Cannot be rolled into thread at any moisture content.
Low..... Dry specimen ball easily crushed with fingers. Can be rolled into 1/8-in. thread with some difficulty.
Medium..... Difficult to crush dry specimen ball with fingers. Easily rolled into 1/8-in. thread.
High..... Cannot crush dry specimen ball with fingers. Easily rolled and re-rolled into 1/8-in. thread.

COBBLES AND BOULDERS

Cobbles - Particles of rock that will pass a 12-in. square opening and be retained on a 3-in. sieve.
Boulders - Particles of rock that will not pass a 12-in. square opening.

Note: Where the percentage (by volume) of cobbles and/or boulders cannot be accurately or reliably estimated, the terms "with cobbles", "with boulders", or "with cobbles and boulders" may be used to indicate observed or inferred presence.

GUIDE TO SUBSURFACE EXPLORATION LOGS



INDEX SHEET 3 ROCK DESCRIPTION

ROCK DEFINITION

Where reported on an exploration log, *rock* is defined as any naturally formed aggregate of mineral matter occurring in larges masses or fragments. This definition of rock should not be taken as a replacement for any definitions relating to rock and/or rock excavation defined in construction documents. Intensely weathered or decomposed rock that is friable and can be reduced to gravel size particles or smaller by normal hand pressure is identified and described as soil. Poorly indurated formational materials which display both rock-like and soil-like properties are identified and described as rock followed by the soil description. In such cases, the term "poorly indurated" or "weakly cemented" is added to the rock name (e.g. weakly cemented sandstone).

ROCK IDENTIFICATION

Rock is identified by a combination of *rock type* (igneous, metamorphic, or sedimentary) followed by the the *rock name* (e.g. granite, schist, sandstone).

ROCK DESCRIPTION

Rock descriptions are presented in the following general sequence. The detail of description is dictated by the complexity and objectives of the project.

Identification Components

(1) Rock Type and Name

Description Components

- (2) Rock Grain Size (*for clastic sedimentary rock*)
- (3) Crystal Size (*for igneous and metamorphic rock*)
- (4) Bedding Spacing (*for sedimentary rock*)
- (5) Color
- (6) Hardness and Weathering Descriptors
- (7) Fracture Density
- (8) [Geologic Formation Name]

ROCK QUALITY DESIGNATION

$$RQD (\%) = \frac{\sum \text{Length of intact core pieces} \geq 4 \text{ inches}}{\text{Total length of core run (inches)}} \times 100$$

The RQD should correlate with the fracture density in most cases. Higher RDQ values generally indicate fewer joints and fractures.

GRAIN / CRYSTAL SIZE

Grain Size for Clastic Sedimentary Rock

The names of clastic sedimentary rocks are generally based on their predominant clast or grain size (e.g. fine sandstone, medium sandstone, coarse gravel conglomerate, cobble conglomerate, siltstone, claystone).

Crystal Size for Igneous and Metamorphic Rock

Grain Size Description	Average Crystal Size (in.)
Very coarse grained (pegmatitic)	Greater than or equal to 3/8
Coarse-grained	Between 3/16 and 3/8
Medium-grained	Between 1/32 and 3/16
Fine-grained	Between 1/250 and 1/32
Aphanitic	Less than or equal to 1/250

BEDDING SPACING

Bedding Description	Thickness / Spacing
Massive	Less than 10 ft.
Very thickly bedded	3 ft. to 10 ft.
Thickly bedded	1 ft. to 3 ft.
Moderately bedded	4 in. to 1 ft.
Thinly bedded	1 in. to 4 in.
Very thinly bedded	1/4 in. to 1 in.
Laminated	Less than 1/4 in.

Note: Bedding is generally only applicable to sedimentary or bedded volcanic rocks.

HARDNESS

Hardness	Criteria
Extremely hard	Cannot be scratched with a pocketknife or sharp pick. Can only be chipped with repeated heavy hammer blows.
Very hard	Cannot be scratched with a pocketknife or sharp pick with difficulty. Breaks with repeated heavy hammer blows.
Hard	Can be scratched with with a pocketknife or sharp pick with difficulty. Breaks with heavy hammer blows.
Moderately hard	Can be scratched with a pocketknife or sharp pick with light or moderate pressure. Breaks with moderate hammer blows.
Moderately soft	Can be grooved 1/16 in. deep with a pocketknife or sharp pick with moderate or heavy pressure. Breaks with light hammer blow or heavy manual pressure.
Soft	Can be grooved or gouged easily with a pocketknife or sharp pick. Breaks with light to moderate manual pressure.
Very soft	Can be readily indented, grooved, or gouged with fingernail, or carved with a pocketknife. Breaks with light manual pressure.

WEATHERING (INTACT ROCK)

Weathering Description	Discoloration and/or Oxidation	General Characteristics
Fresh	Body of rock and fracture surfaces are not discolored or oxidized.	Rock texture unchanged. Hammer rings when crystalline rocks are struck.
Slightly weathered	Discoloration or oxidation limited to surface of, or short distance from, fractures. Most surfaces exhibit minor to complete discoloration.	Rock texture preserved. Hammer rings when crystalline rocks are struck. Body of rock not weakened.
Moderately weathered	Discoloration or oxidation extends usually throughout. Fe-Mg minerals appear rusty. All fracture surfaces are discolored or oxidized.	Rock texture generally preserved. Hammer does not ring when rock is struck. Body of rock slightly weakened.
Intensely weathered	Discoloration or oxidation throughout. Feldspar and Fe-Mg minerals altered to clay to some extent. All fracture surfaces are discolored or oxidized and friable.	Rock texture altered by chemical disintegration. Can usually be broken with moderate to heavy manual pressure or by light hammer blow . Body of rock is significantly weakened.
Decomposed	Discoloration or oxidation throughout but resistant minerals such as quartz may be unaltered. All feldspar and Fe-Mg minerals are completely altered to clay.	Resembles a soil; partial or complete remnant rock structure may be preserved. Can be granulated by hand. Resistant minerals may present as stringers or dikes.

FRACTURE DENSITY

Description	Observed Fracture Density
Unfractured	No fractures
Very slightly fractured	Core lengths greater than 3 ft.
Slightly fractured	Core lengths mostly from 1 ft. to 3 ft.
Moderately fractured	Core lengths mostly from 4 in. to 1 ft.
Intensely fractured	Core lengths mostly from 1 in. to 4 in.
Very intensely fractured	Mostly chips and fragments

Note: Fracture density is based on the fracture spacing in recovered core, measured along the core axis (excluding mechanical breaks).

ATTACHMENT B

Test Pit Logs

CONTRACTOR: Technical Drilling Services, Inc.	TEST PIT LOCATION: See site plan	DATE START: June 17, 2020
OPERATOR: D. Watson	PLAN DIMENSIONS: Length: 11.0 ft. , Width: 2.5 ft.	DATE FINISH: June 17, 2020
LOGGED BY: S. Wuebbolt, EIT	SEEPAGE REMARKS: Slow Seepage Below 3.8 ft.	GROUND EL: 14.0 ± (Boston City Base)
CHECKED BY: M. Zanchi, EIT	CAVING REMARKS: Moderate Caving Below 3.5 ft.	FINAL DEPTH: 6.2 ft.
EQUIPMENT: Ford New Holland 555E Backhoe	BACKFILL MATERIAL: Excavated Soil	GRID COORDS: N/A
BUCKET TYPE: Toothed, 24-in. (6.4 cubic-ft.)	OTHER COMMENTS:	GRID SYSTEM: N/A

DEPTH BELOW GROUND SURFACE [VERTICAL FT.]	SAMPLE TYPE GRAPHIC	PID MEASUREMENT, PPM	STRATIGRAPHY LOG	STRATUM IDENTIFICATION AND DESCRIPTION	ELEVATION SCALE SHOWN TO NEAREST FT.	REMARKS, OTHER TESTS, AND INSTALLATIONS
				Surface: Grass field. Topsoil- Approx. 6" thick.		Note: Values in brackets preceding a remark indicate depth below ground surface (in feet) corresponding to the remark.
	G	0.8		Poorly graded sand with silt and gravel (SP-SM) - Brown; moist to wet; mostly fine to coarse SAND, some fine to coarse gravel, few non plastic fines; occasional cobbles; trace boulders; trace debris (glass, slag, possible leather). [FILL]		
	G	0.9				
5	G	186.3		Lean clay with sand (CL) - Dark brown; wet; mostly medium plasticity FINES, little fine to coarse sand, few fine to coarse gravel; petroleum-like odor; occasional shells. [FILL]	9	
						Exploration ended at 6.2 ft.



Figure 1: Completed Test Pit - View 1



Figure 2: Completed Test Pit - View 2

CONTRACTOR: Technical Drilling Services, Inc.	TEST PIT LOCATION: See site plan	DATE START: June 17, 2020
OPERATOR: D. Watson	PLAN DIMENSIONS: Length: 13.3 ft. , Width: 2.7 ft.	DATE FINISH: June 17, 2020
LOGGED BY: S. Wuebbolt, EIT	SEEPAGE REMARKS: Slow Seepage Below 6.3 ft.	GROUND EL: 14.0 ± (Boston City Base)
CHECKED BY: M. Zanchi, EIT	CAVING REMARKS: Moderate Caving Below 6.0 ft.	FINAL DEPTH: 11.0 ft.
EQUIPMENT: Ford New Holland 555E Backhoe	BACKFILL MATERIAL: Excavated Soil	GRID COORDS: N/A
BUCKET TYPE: Toothed, 24-in. (6.4 cubic-ft.)	OTHER COMMENTS:	GRID SYSTEM: N/A

DEPTH BELOW GROUND SURFACE [VERTICAL FT.]	SAMPLE TYPE GRAPHIC	PID MEASUREMENT, PPM	STRATIGRAPHY LOG	STRATUM IDENTIFICATION AND DESCRIPTION	ELEVATION SCALE SHOWN TO NEAREST FT.	REMARKS, OTHER TESTS, AND INSTALLATIONS
				Surface: Grass field. Topsoil- Approx. 13" thick.		
	G	0.3				
	G	0.4		Silty sand (SM) - Dark brown; moist; mostly fine to coarse SAND, little non plastic fines, few fine to coarse gravel; occasional cobbles; trace boulders. [FILL]		[2.0 - 4.5] Moderately difficult excavation.
	G	2.3				
5				Silty sand with gravel (SM) - Dark brown; moist to wet; mostly fine to coarse SAND, some fine to coarse gravel, little non plastic fines; petroleum-like odor; occasional debris (glass, possible cinders and coal). [FILL]	9	[4.5 - 6.0] Difficult excavation.
	G	13.5				
	G	1.2		Lean clay with sand (CL) - Gray; wet; mostly medium plasticity FINES, little fine sand; occasional shells. [FILL]		

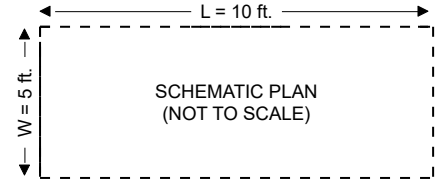

Figure 1: Completed Test Pit - View 1



Figure 2: Completed Test Pit - View 2

CONTRACTOR: Technical Drilling Services, Inc. DATE START: June 17, 2020
 OPERATOR: D. Watson DATE FINISH: June 17, 2020
 LOGGED BY: S. Wuebbolt, EIT GROUND EL: 14.0 ± (Boston City Base)
 CHECKED BY: M. Zanchi, EIT FINAL DEPTH: 11.0 ft.
 EQUIPMENT: Ford New Holland 555E Backhoe LOCATION: See Attached Plan
 BUCKET TYPE: N/A GRID SYSTEM: N/A



DEPTH BELOW GROUND SURFACE [VERTICAL FT.]	SAMPLE TYPE GRAPHIC	PID MEASUREMENT, PPM	STRATIGRAPHY LOG	STRATUM IDENTIFICATION AND DESCRIPTION	ELEVATION SCALE SHOWN TO NEAREST FT.	REMARKS, OTHER TESTS, AND INSTALLATIONS
15	G	1.4		<p>Sandy lean clay with gravel (CL) - Gray; wet; mostly medium plasticity FINES, some fine to coarse sand, little fine to coarse gravel; numerous debris (porcelain, cinders, wood, coal); numerous shells. [FILL]</p>	-1	<p>Note: Values in brackets preceding a remark indicate depth below ground surface (in feet) corresponding to the remark.</p> <p>Exploration ended at 11.0 ft.</p>



CONTRACTOR: Technical Drilling Services, Inc.	TEST PIT LOCATION: See site plan	DATE START: June 17, 2020
OPERATOR: D. Watson	PLAN DIMENSIONS: Length: 11.0 ft. , Width: 2.5 ft.	DATE FINISH: June 17, 2020
LOGGED BY: S.Wuebbolt, EIT	SEEPAGE REMARKS: Slow Seepage Below 6.8 ft.	GROUND EL: 14.0 ± (Boston City Base)
CHECKED BY: M. Zanchi, EIT	CAVING REMARKS: Minor Caving Below 3.0 ft.	FINAL DEPTH: 6.8 ft.
EQUIPMENT: Ford New Holland 555E Backhoe	BACKFILL MATERIAL: Excavated Soil	GRID COORDS: N/A
BUCKET TYPE: Toothed, 24-in. (6.4 cubic-ft.)	OTHER COMMENTS:	GRID SYSTEM: N/A

DEPTH BELOW GROUND SURFACE [VERTICAL FT.]	SAMPLE TYPE GRAPHIC	PID MEASUREMENT, PPM	STRATIGRAPHY LOG	STRATUM IDENTIFICATION AND DESCRIPTION	ELEVATION SCALE SHOWN TO NEAREST FT.	REMARKS, OTHER TESTS, AND INSTALLATIONS
				Surface: Grass field. Topsoil- Approx. 12" thick.		Note: Values in brackets preceding a remark indicate depth below ground surface (in feet) corresponding to the remark.
	G	0.3		Silty sand with gravel (SM) - Brown; moist; mostly fine to medium SAND, some fine to coarse gravel, little non plastic fines; common cobbles. [FILL]		
	G	0.2			9	[4.0 - 6.8] Moderately difficult excavation.
5	G	0.2		Poorly graded sand with silt and gravel (SP-SM) - Gray; moist to wet; mostly fine to coarse SAND, little fine to coarse gravel, few non plastic fines; numerous debris (cinders, ash). [FILL]		
						Exploration ended at 6.8 ft.



Figure 1: Completed Test Pit - View 1



Figure 2: Completed Test Pit - View 2

CONTRACTOR: Technical Drilling Services, Inc.	TEST PIT LOCATION: See site plan	DATE START: June 17, 2020
OPERATOR: D. Watson	PLAN DIMENSIONS: Length: 11.7 ft. , Width: 2.9 ft.	DATE FINISH: June 17, 2020
LOGGED BY: S. Wuebbolt, EIT	SEEPAGE REMARKS: Slow Seepage Below 6.4 ft.	GROUND EL: 13.0 ± (Boston City Base)
CHECKED BY: M. Zanchi, EIT	CAVING REMARKS: Minor Caving Below 6.0 ft.	FINAL DEPTH: 8.7 ft.
EQUIPMENT: Ford New Holland 555E Backhoe	BACKFILL MATERIAL: Excavated Soil	GRID COORDS: N/A
BUCKET TYPE: Toothed, 24-in. (6.4 cubic-ft.)	OTHER COMMENTS:	GRID SYSTEM: N/A

DEPTH BELOW GROUND SURFACE [VERTICAL FT.]	SAMPLE TYPE GRAPHIC	PID MEASUREMENT, PPM	STRATIGRAPHY LOG	STRATUM IDENTIFICATION AND DESCRIPTION	ELEVATION SCALE SHOWN TO NEAREST FT.	REMARKS, OTHER TESTS, AND INSTALLATIONS
				Surface: Grass field.		
	G	0.5		Topsoil- Approx. 7" thick.		
	G	0.5		Poorly graded sand with silt and gravel (SP-SM) - Dark brown; moist; mostly fine to coarse SAND, some fine to coarse gravel, few non plastic fines; trace cobbles; trace debris (cinders, slag, glass, wood, fabric). [FILL] <u>Buried metal cable observed at approximately 1.5 ft</u>		[2.0 - 8.7] Moderately difficult excavation.
5	G	0.4		Lean clay with sand (CL) - Gray; moist to wet; mostly medium plasticity FINES, little fine to coarse sand, few fine to coarse gravel; occasional debris (cinders, glass, brick). [FILL]	8	
						Exploration ended at 8.7 ft.



Figure 1: Completed Test Pit - View 1



Figure 2: Completed Test Pit - View 2

CONTRACTOR: Technical Drilling Services, Inc.	TEST PIT LOCATION: See site plan	DATE START: June 17, 2020
OPERATOR: D. Watson	PLAN DIMENSIONS: Length: 11.8 ft. , Width: 2.3 ft.	DATE FINISH: June 17, 2020
LOGGED BY: S.Wuebbolt, EIT	SEEPAGE REMARKS: No Seepage Observed	GROUND EL: 15.0 ± (Boston City Base)
CHECKED BY: M. Zanchi, EIT	CAVING REMARKS: Minor Caving Below 4.0 ft.	FINAL DEPTH: 7.7 ft.
EQUIPMENT: Ford New Holland 555E Backhoe	BACKFILL MATERIAL: Excavated Soil	GRID COORDS: N/A
BUCKET TYPE: Toothed, 24-in. (6.4 cubic-ft.)	OTHER COMMENTS:	GRID SYSTEM: N/A

DEPTH BELOW GROUND SURFACE [VERTICAL FT.]	SAMPLE TYPE GRAPHIC	PID MEASUREMENT, PPM	STRATIGRAPHY LOG	STRATUM IDENTIFICATION AND DESCRIPTION	ELEVATION SCALE SHOWN TO NEAREST FT.	REMARKS, OTHER TESTS, AND INSTALLATIONS
				Surface: Grass field. Topsoil- Approx. 6" thick.		
	G	0.7		Silty sand with gravel (SM) - Brown; moist; mostly fine to medium SAND, little non plastic fines, little fine to coarse gravel; occasional cobbles; trace boulders; occasional roots. [FILL]		[0.0 - 3.0] Moderately difficult excavation.
	G	0.6		Poorly graded sand with silt and gravel (SP-SM) - Brown; moist; mostly fine to coarse SAND, some fine to coarse gravel, few non plastic fines; occasional conglomerate cobbles; trace boulders; occasional debris (cinders, slag, glass, brick). [FILL]		[3.0 - 4.0] Difficult excavation.
	G	0.5		Silt (ML) - Gray; moist; mostly non plastic FINES, few fine to medium sand. [FILL]		
5					10	
	G	0.8		Peat (PT) - Spongy; dark brown; moist; fibrous.		
						Exploration ended at 7.7 ft.



Figure 1: Completed Test Pit - View 1



Figure 2: Completed Test Pit - View 2

ATTACHMENT C

Geotechnical Laboratory Test Results



Client:	Weston & Sampson Engineers		
Project:	McConnell Park		
Location:	Boston, MA	Project No:	GTX-312010
Boring ID:	---	Sample Type:	---
Sample ID:	---	Test Date:	07/14/20
Depth :	---	Test Id:	564072
		Tested By:	cam
		Checked By:	jsc

Moisture, Ash, and Organic Matter - ASTM D2974

Boring ID	Sample ID	Depth	Description	Moisture Content, %	Ash Content, %	Organic Matter, %
B-1	S-7	15-17	Moist, very dark grayish brown silt with organics	159	77.1	22.9
B-3	S-4	6-8	Moist, very dark brown silt with organics	272	66.9	33.1
B-7	S-4	15-17	Moist, dark gray clay	56	96.6	3.4
B-8	S-7	15-17	Moist, very dark brown silt with organics	153	82.6	17.4

Notes: Moisture content determined by Method A and reported as a percentage of oven-dried mass; dried to a constant mass at temperature of 105° C
 Ash content and organic matter determined by Method C; dried to constant mass at temperature 440° C



Client: Weston & Sampson Engineers	Project No: GTX-312010
Project: McConnell Park	
Location: Boston, MA	
Boring ID: B-3	Sample Type: jar
Sample ID: S-2	Test Date: 07/15/20
Depth: 2-4	Test Id: 564068
Test Comment: ---	Tested By: ckg
Visual Description: Moist, grayish brown silty gravel with sand	Checked By: jsc
Sample Comment: ---	

Particle Size Analysis - ASTM D422

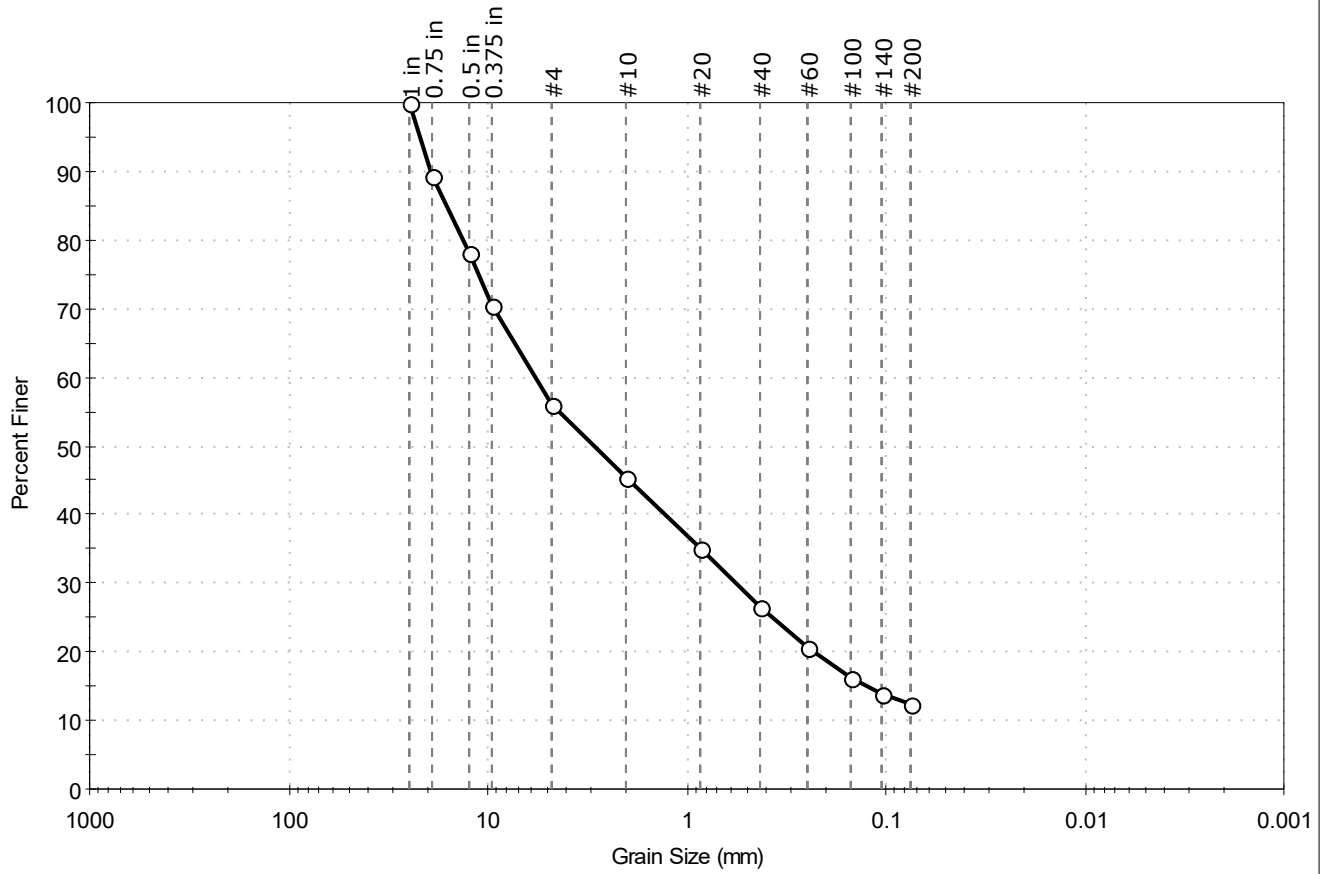

% Cobble	% Gravel	% Sand	% Silt & Clay Size
—	43.9	43.8	12.3

Sieve Name	Sieve Size, mm	Percent Finer	Spec. Percent	Complies
1 in	25.00	100		
0.75 in	19.00	89		
0.5 in	12.50	78		
0.375 in	9.50	71		
#4	4.75	56		
#10	2.00	46		
#20	0.85	35		
#40	0.42	26		
#60	0.25	21		
#100	0.15	16		
#140	0.11	14		
#200	0.075	12		

<u>Coefficients</u>	
D ₈₅ = 16.1687 mm	D ₃₀ = 0.5662 mm
D ₆₀ = 5.7223 mm	D ₁₅ = 0.1249 mm
D ₅₀ = 2.8859 mm	D ₁₀ = N/A
C _u = N/A	C _c = N/A

<u>Classification</u>	
ASTM	N/A
AASHTO	Stone Fragments, Gravel and Sand (A-1-a (0))

<u>Sample/Test Description</u>
Sand/Gravel Particle Shape : ROUNDED
Sand/Gravel Hardness : HARD



Client: Weston & Sampson Engineers	Project No: GTX-312010
Project: McConnell Park	
Location: Boston, MA	
Boring ID: B-1	Sample Type: jar
Sample ID: S-10	Test Date: 07/17/20
Depth: 25-27	Test Id: 564066
Test Comment: ---	Tested By: cam
Visual Description: Moist, dark grayish brown clay	Checked By: jsc
Sample Comment: ---	

Atterberg Limits - ASTM D4318

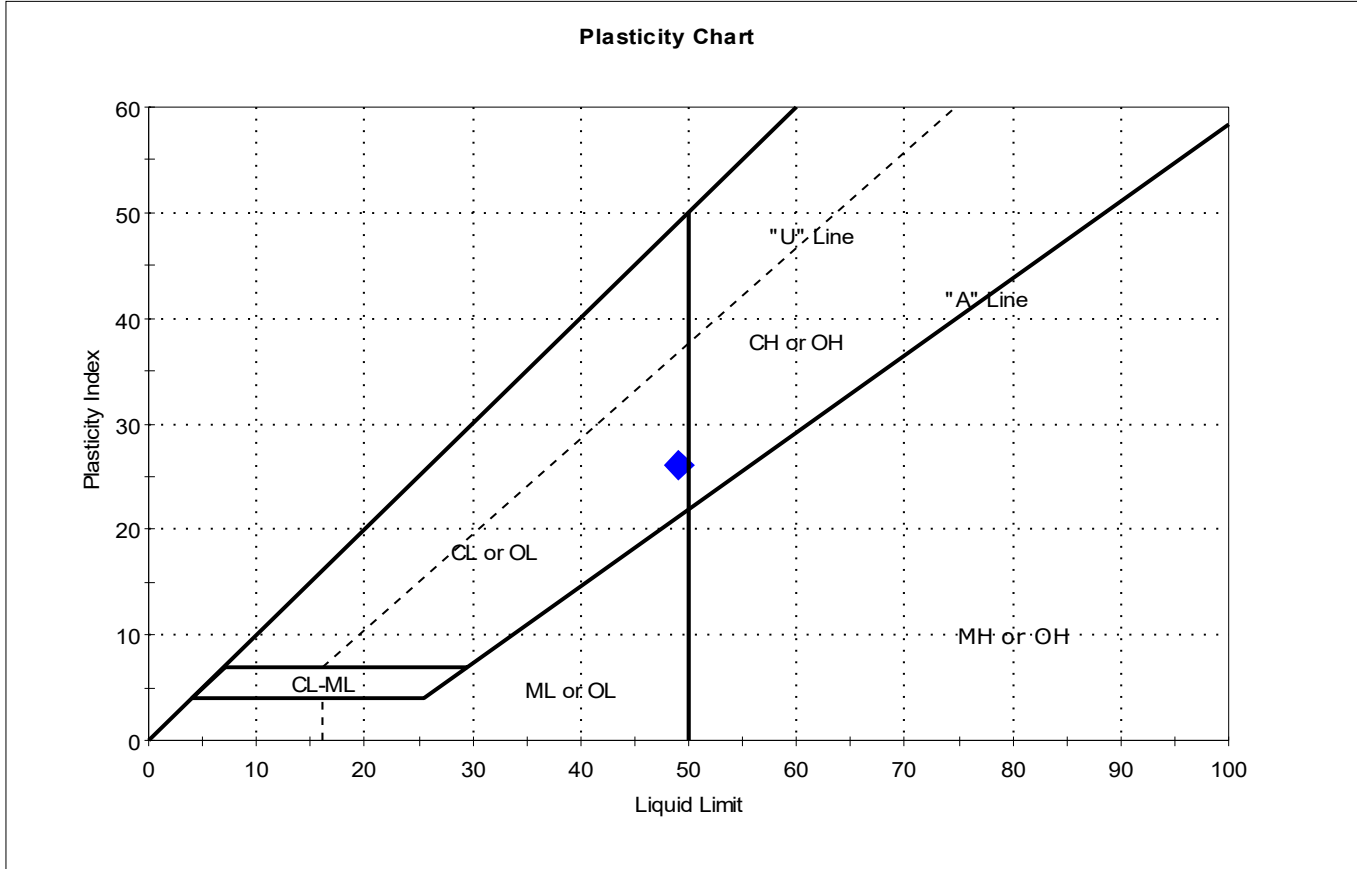

Symbol	Sample ID	Boring	Depth	Natural Moisture Content, %	Liquid Limit	Plastic Limit	Plasticity Index	Liquidity Index	Soil Classification
◆	S-10	B-1	25-27	31	49	23	26	0.3	

Sample Prepared using the WET method

Dry Strength: VERY HIGH

Dilatancy: SLOW

Toughness: LOW



Client: Weston & Sampson Engineers	Project No: GTX-312010
Project: McConnell Park	
Location: Boston, MA	
Boring ID: B-6	Sample Type: jar
Sample ID: S-3	Test Date: 07/17/20
Depth: 20-22	Test Id: 564067
Test Comment: ---	Tested By: cam
Visual Description: Moist, dark gray clay	Checked By: jsc
Sample Comment: ---	

Atterberg Limits - ASTM D4318

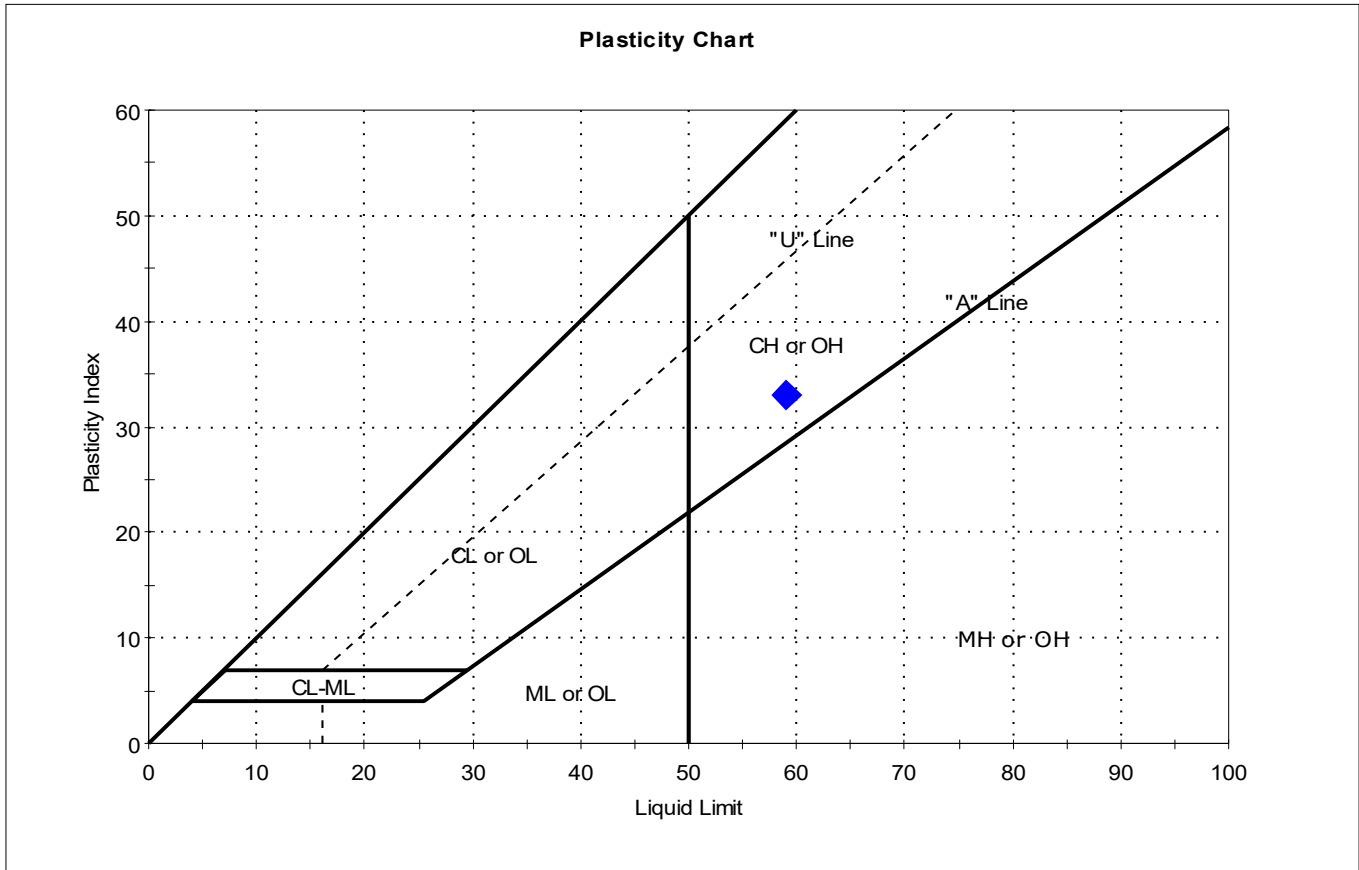

Symbol	Sample ID	Boring	Depth	Natural Moisture Content, %	Liquid Limit	Plastic Limit	Plasticity Index	Liquidity Index	Soil Classification
◆	S-3	B-6	20-22	52	59	26	33	0.8	

Sample Prepared using the WET method

Dry Strength: HIGH
 Dilatancy: SLOW
 Toughness: LOW

ATTACHMENT D

Important Information about This Geotechnical-Engineering Report

Important Information about This

Geotechnical-Engineering Report

Subsurface problems are a principal cause of construction delays, cost overruns, claims, and disputes.

While you cannot eliminate all such risks, you can manage them. The following information is provided to help.

The Geoprofessional Business Association (GBA) has prepared this advisory to help you – assumedly a client representative – interpret and apply this geotechnical-engineering report as effectively as possible. In that way, you can benefit from a lowered exposure to problems associated with subsurface conditions at project sites and development of them that, for decades, have been a principal cause of construction delays, cost overruns, claims, and disputes. If you have questions or want more information about any of the issues discussed herein, contact your GBA-member geotechnical engineer. Active engagement in GBA exposes geotechnical engineers to a wide array of risk-confrontation techniques that can be of genuine benefit for everyone involved with a construction project.

Understand the Geotechnical-Engineering Services Provided for this Report

Geotechnical-engineering services typically include the planning, collection, interpretation, and analysis of exploratory data from widely spaced borings and/or test pits. Field data are combined with results from laboratory tests of soil and rock samples obtained from field exploration (if applicable), observations made during site reconnaissance, and historical information to form one or more models of the expected subsurface conditions beneath the site. Local geology and alterations of the site surface and subsurface by previous and proposed construction are also important considerations. Geotechnical engineers apply their engineering training, experience, and judgment to adapt the requirements of the prospective project to the subsurface model(s). Estimates are made of the subsurface conditions that will likely be exposed during construction as well as the expected performance of foundations and other structures being planned and/or affected by construction activities.

The culmination of these geotechnical-engineering services is typically a geotechnical-engineering report providing the data obtained, a discussion of the subsurface model(s), the engineering and geologic engineering assessments and analyses made, and the recommendations developed to satisfy the given requirements of the project. These reports may be titled investigations, explorations, studies, assessments, or evaluations. Regardless of the title used, the geotechnical-engineering report is an engineering interpretation of the subsurface conditions within the context of the project and does not represent a close examination, systematic inquiry, or thorough investigation of all site and subsurface conditions.

Geotechnical-Engineering Services are Performed for Specific Purposes, Persons, and Projects, and At Specific Times

Geotechnical engineers structure their services to meet the specific needs, goals, and risk management preferences of their clients. A geotechnical-engineering study conducted for a given civil engineer

will not likely meet the needs of a civil-works constructor or even a different civil engineer. Because each geotechnical-engineering study is unique, each geotechnical-engineering report is unique, prepared *solely* for the client.

Likewise, geotechnical-engineering services are performed for a specific project and purpose. For example, it is unlikely that a geotechnical-engineering study for a refrigerated warehouse will be the same as one prepared for a parking garage; and a few borings drilled during a preliminary study to evaluate site feasibility will not be adequate to develop geotechnical design recommendations for the project.

Do not rely on this report if your geotechnical engineer prepared it:

- for a different client;
- for a different project or purpose;
- for a different site (that may or may not include all or a portion of the original site); or
- before important events occurred at the site or adjacent to it; e.g., man-made events like construction or environmental remediation, or natural events like floods, droughts, earthquakes, or groundwater fluctuations.

Note, too, the reliability of a geotechnical-engineering report can be affected by the passage of time, because of factors like changed subsurface conditions; new or modified codes, standards, or regulations; or new techniques or tools. *If you are the least bit uncertain* about the continued reliability of this report, contact your geotechnical engineer before applying the recommendations in it. A minor amount of additional testing or analysis after the passage of time – if any is required at all – could prevent major problems.

Read this Report in Full

Costly problems have occurred because those relying on a geotechnical-engineering report did not read the report in its entirety. Do not rely on an executive summary. Do not read selective elements only. *Read and refer to the report in full.*

You Need to Inform Your Geotechnical Engineer About Change

Your geotechnical engineer considered unique, project-specific factors when developing the scope of study behind this report and developing the confirmation-dependent recommendations the report conveys. Typical changes that could erode the reliability of this report include those that affect:

- the site's size or shape;
- the elevation, configuration, location, orientation, function or weight of the proposed structure and the desired performance criteria;
- the composition of the design team; or
- project ownership.

As a general rule, *always* inform your geotechnical engineer of project or site changes – even minor ones – and request an assessment of their impact. *The geotechnical engineer who prepared this report cannot accept*

responsibility or liability for problems that arise because the geotechnical engineer was not informed about developments the engineer otherwise would have considered.

Most of the “Findings” Related in This Report Are Professional Opinions

Before construction begins, geotechnical engineers explore a site’s subsurface using various sampling and testing procedures. *Geotechnical engineers can observe actual subsurface conditions only at those specific locations where sampling and testing is performed.* The data derived from that sampling and testing were reviewed by your geotechnical engineer, who then applied professional judgement to form opinions about subsurface conditions throughout the site. Actual sitewide-subsurface conditions may differ – maybe significantly – from those indicated in this report. Confront that risk by retaining your geotechnical engineer to serve on the design team through project completion to obtain informed guidance quickly, whenever needed.

This Report’s Recommendations Are Confirmation-Dependent

The recommendations included in this report – including any options or alternatives – are confirmation-dependent. In other words, they are not final, because the geotechnical engineer who developed them relied heavily on judgement and opinion to do so. Your geotechnical engineer can finalize the recommendations *only after observing actual subsurface conditions* exposed during construction. If through observation your geotechnical engineer confirms that the conditions assumed to exist actually do exist, the recommendations can be relied upon, assuming no other changes have occurred. *The geotechnical engineer who prepared this report cannot assume responsibility or liability for confirmation-dependent recommendations if you fail to retain that engineer to perform construction observation.*

This Report Could Be Misinterpreted

Other design professionals’ misinterpretation of geotechnical-engineering reports has resulted in costly problems. Confront that risk by having your geotechnical engineer serve as a continuing member of the design team, to:

- confer with other design-team members;
- help develop specifications;
- review pertinent elements of other design professionals’ plans and specifications; and
- be available whenever geotechnical-engineering guidance is needed.

You should also confront the risk of constructors misinterpreting this report. Do so by retaining your geotechnical engineer to participate in prebid and preconstruction conferences and to perform construction-phase observations.

Give Constructors a Complete Report and Guidance

Some owners and design professionals mistakenly believe they can shift unanticipated-subsurface-conditions liability to constructors by limiting the information they provide for bid preparation. To help prevent the costly, contentious problems this practice has caused, include the complete geotechnical-engineering report, along with any attachments or appendices, with your contract documents, *but be certain to note*

conspicuously that you’ve included the material for information purposes only. To avoid misunderstanding, you may also want to note that “informational purposes” means constructors have no right to rely on the interpretations, opinions, conclusions, or recommendations in the report. Be certain that constructors know they may learn about specific project requirements, including options selected from the report, *only* from the design drawings and specifications. Remind constructors that they may perform their own studies if they want to, and *be sure to allow enough time* to permit them to do so. Only then might you be in a position to give constructors the information available to you, while requiring them to at least share some of the financial responsibilities stemming from unanticipated conditions. Conducting prebid and preconstruction conferences can also be valuable in this respect.

Read Responsibility Provisions Closely

Some client representatives, design professionals, and constructors do not realize that geotechnical engineering is far less exact than other engineering disciplines. This happens in part because soil and rock on project sites are typically heterogeneous and not manufactured materials with well-defined engineering properties like steel and concrete. That lack of understanding has nurtured unrealistic expectations that have resulted in disappointments, delays, cost overruns, claims, and disputes. To confront that risk, geotechnical engineers commonly include explanatory provisions in their reports. Sometimes labeled “limitations,” many of these provisions indicate where geotechnical engineers’ responsibilities begin and end, to help others recognize their own responsibilities and risks. *Read these provisions closely.* Ask questions. Your geotechnical engineer should respond fully and frankly.

Geoenvironmental Concerns Are Not Covered

The personnel, equipment, and techniques used to perform an environmental study – e.g., a “phase-one” or “phase-two” environmental site assessment – differ significantly from those used to perform a geotechnical-engineering study. For that reason, a geotechnical-engineering report does not usually provide environmental findings, conclusions, or recommendations; e.g., about the likelihood of encountering underground storage tanks or regulated contaminants. *Unanticipated subsurface environmental problems have led to project failures.* If you have not obtained your own environmental information about the project site, ask your geotechnical consultant for a recommendation on how to find environmental risk-management guidance.

Obtain Professional Assistance to Deal with Moisture Infiltration and Mold

While your geotechnical engineer may have addressed groundwater, water infiltration, or similar issues in this report, the engineer’s services were not designed, conducted, or intended to prevent migration of moisture – including water vapor – from the soil through building slabs and walls and into the building interior, where it can cause mold growth and material-performance deficiencies. Accordingly, *proper implementation of the geotechnical engineer’s recommendations will not of itself be sufficient to prevent moisture infiltration.* **Confront the risk of moisture infiltration** by including building-envelope or mold specialists on the design team. **Geotechnical engineers are not building-envelope or mold specialists.**



Telephone: 301/565-2733

e-mail: info@geoprofessional.org www.geoprofessional.org

Attachment D - HydroCAD Reports



NOAA Atlas 14, Volume 10, Version 3
Location name: Dorchester, Massachusetts, USA*
Latitude: 42.3089°, Longitude: -71.0519°
Elevation: 8.16 ft**
 * source: ESRI Maps
 ** source: USGS



POINT PRECIPITATION FREQUENCY ESTIMATES

Sanja Perica, Sandra Pavlovic, Michael St. Laurent, Carl Trypaluk, Dale Unruh, Orlan Wilhite

NOAA, National Weather Service, Silver Spring, Maryland

[PF tabular](#) | [PF graphical](#) | [Maps & aerials](#)

PF tabular

PDS-based point precipitation frequency estimates with 90% confidence intervals (in inches)¹										
Duration	Average recurrence interval (years)									
	1	2	5	10	25	50	100	200	500	1000
5-min	0.301 (0.247-0.366)	0.373 (0.306-0.453)	0.490 (0.400-0.599)	0.587 (0.476-0.723)	0.721 (0.562-0.942)	0.820 (0.625-1.10)	0.927 (0.682-1.31)	1.06 (0.720-1.52)	1.25 (0.812-1.88)	1.41 (0.893-2.18)
10-min	0.426 (0.350-0.518)	0.528 (0.433-0.642)	0.694 (0.567-0.848)	0.832 (0.675-1.02)	1.02 (0.796-1.34)	1.16 (0.885-1.56)	1.31 (0.966-1.86)	1.49 (1.02-2.16)	1.77 (1.15-2.67)	2.00 (1.26-3.09)
15-min	0.501 (0.412-0.609)	0.621 (0.510-0.756)	0.816 (0.667-0.999)	0.978 (0.794-1.21)	1.20 (0.937-1.57)	1.37 (1.04-1.84)	1.55 (1.14-2.19)	1.76 (1.20-2.54)	2.08 (1.35-3.14)	2.35 (1.49-3.63)
30-min	0.683 (0.561-0.830)	0.847 (0.695-1.03)	1.12 (0.911-1.36)	1.34 (1.09-1.65)	1.64 (1.28-2.15)	1.87 (1.42-2.52)	2.11 (1.56-2.99)	2.41 (1.64-3.48)	2.85 (1.86-4.30)	3.23 (2.05-4.99)
60-min	0.864 (0.710-1.05)	1.07 (0.880-1.31)	1.41 (1.16-1.73)	1.70 (1.38-2.09)	2.08 (1.63-2.73)	2.37 (1.81-3.19)	2.68 (1.98-3.80)	3.06 (2.09-4.42)	3.63 (2.36-5.47)	4.11 (2.60-6.35)
2-hr	1.11 (0.917-1.34)	1.39 (1.15-1.68)	1.86 (1.53-2.25)	2.24 (1.83-2.74)	2.77 (2.18-3.61)	3.16 (2.42-4.24)	3.59 (2.67-5.06)	4.12 (2.82-5.89)	4.93 (3.22-7.36)	5.64 (3.58-8.61)
3-hr	1.29 (1.07-1.55)	1.62 (1.35-1.95)	2.17 (1.79-2.62)	2.62 (2.14-3.19)	3.24 (2.55-4.20)	3.69 (2.84-4.93)	4.19 (3.13-5.89)	4.82 (3.30-6.86)	5.78 (3.78-8.58)	6.62 (4.21-10.1)
6-hr	1.69 (1.41-2.01)	2.10 (1.75-2.52)	2.78 (2.31-3.34)	3.35 (2.76-4.05)	4.13 (3.27-5.30)	4.70 (3.64-6.21)	5.33 (3.98-7.40)	6.10 (4.20-8.60)	7.30 (4.79-10.7)	8.33 (5.31-12.5)
12-hr	2.19 (1.84-2.59)	2.69 (2.26-3.20)	3.51 (2.94-4.19)	4.19 (3.48-5.04)	5.13 (4.09-6.53)	5.83 (4.53-7.62)	6.58 (4.93-9.03)	7.50 (5.19-10.5)	8.90 (5.86-12.9)	10.1 (6.46-15.0)
24-hr	2.65 (2.24-3.12)	3.28 (2.77-3.87)	4.31 (3.62-5.10)	5.16 (4.31-6.15)	6.33 (5.08-8.00)	7.19 (5.63-9.35)	8.14 (6.15-11.1)	9.31 (6.47-12.9)	11.1 (7.35-16.0)	12.7 (8.15-18.6)
2-day	3.01 (2.57-3.53)	3.81 (3.24-4.46)	5.11 (4.33-6.01)	6.19 (5.20-7.33)	7.67 (6.20-9.66)	8.76 (6.91-11.3)	9.96 (7.61-13.6)	11.5 (8.02-15.8)	14.0 (9.29-20.0)	16.2 (10.4-23.6)
3-day	3.30 (2.83-3.85)	4.16 (3.56-4.86)	5.57 (4.73-6.52)	6.73 (5.68-7.94)	8.33 (6.76-10.5)	9.50 (7.53-12.3)	10.8 (8.29-14.7)	12.5 (8.73-17.0)	15.3 (10.1-21.6)	17.7 (11.4-25.6)
4-day	3.58 (3.07-4.17)	4.47 (3.83-5.20)	5.92 (5.04-6.91)	7.11 (6.02-8.37)	8.77 (7.13-11.0)	9.97 (7.92-12.8)	11.3 (8.70-15.3)	13.1 (9.15-17.7)	15.9 (10.6-22.4)	18.5 (11.9-26.5)
7-day	4.35 (3.75-5.03)	5.26 (4.53-6.09)	6.76 (5.79-7.85)	8.00 (6.80-9.35)	9.70 (7.93-12.0)	10.9 (8.73-13.9)	12.3 (9.51-16.5)	14.1 (9.93-19.0)	17.1 (11.4-23.8)	19.7 (12.8-28.0)
10-day	5.05 (4.38-5.82)	5.99 (5.18-6.91)	7.52 (6.47-8.70)	8.79 (7.50-10.2)	10.5 (8.63-13.0)	11.8 (9.43-14.9)	13.2 (10.2-17.5)	15.0 (10.6-20.1)	17.9 (12.0-24.8)	20.5 (13.3-29.0)
20-day	7.08 (6.17-8.10)	8.10 (7.05-9.28)	9.77 (8.46-11.2)	11.2 (9.58-12.9)	13.1 (10.7-15.8)	14.5 (11.5-17.9)	16.0 (12.2-20.6)	17.7 (12.6-23.4)	20.3 (13.6-27.8)	22.4 (14.6-31.3)
30-day	8.75 (7.66-9.97)	9.84 (8.59-11.2)	11.6 (10.1-13.3)	13.1 (11.3-15.1)	15.1 (12.4-18.1)	16.7 (13.3-20.4)	18.3 (13.9-23.1)	19.9 (14.2-26.1)	22.2 (15.0-30.2)	24.0 (15.6-33.3)
45-day	10.8 (9.52-12.3)	12.0 (10.5-13.6)	13.9 (12.1-15.8)	15.5 (13.4-17.7)	17.6 (14.5-21.0)	19.3 (15.4-23.4)	21.0 (15.9-26.2)	22.6 (16.2-29.4)	24.6 (16.7-33.2)	26.1 (17.0-36.0)
60-day	12.6 (11.1-14.3)	13.8 (12.2-15.7)	15.8 (13.8-18.0)	17.4 (15.1-19.9)	19.7 (16.3-23.3)	21.5 (17.2-25.9)	23.2 (17.6-28.7)	24.8 (17.8-32.0)	26.7 (18.1-35.7)	27.9 (18.3-38.3)

¹ Precipitation frequency (PF) estimates in this table are based on frequency analysis of partial duration series (PDS). Numbers in parenthesis are PF estimates at lower and upper bounds of the 90% confidence interval. The probability that precipitation frequency estimates (for a given duration and average recurrence interval) will be greater than the upper bound (or less than the lower bound) is 5%. Estimates at upper bounds are not checked against probable maximum precipitation (PMP) estimates and may be higher than currently valid PMP values. Please refer to NOAA Atlas 14 document for more information.

[Back to Top](#)

PF graphical



LEGEND:







-  IMPERVIOUS AREA
(CN = 98)
-  DIRT BASEBALL FIELD
(CN = 77)
-  LANDSCAPED/GRASSED AREA
(CN = 39)
-  SUBCATCHMENT LABEL
-  POND
-  POINT OF INTEREST
-  FLOW PATH









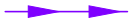
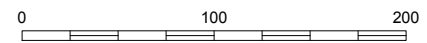

FIGURE 1
MCCONNELL PARK
BOSTON, MASSACHUSETTS
PRE-DEVELOPMENT DRAINAGE MAP
SCALE: 1"=100'





LEGEND:

-  IMPERVIOUS AREA
(CN = 98)
-  DIRT BASEBALL FIELD
(CN = 77)
-  LANDSCAPED/GRASSED AREA
(CN = 39)
-  RUBBER PLAYGROUND
SURFACE (CN = 39)
-  SUBCATCHMENT LABEL
-  POND
-  POINT OF INTEREST
-  FLOW PATH

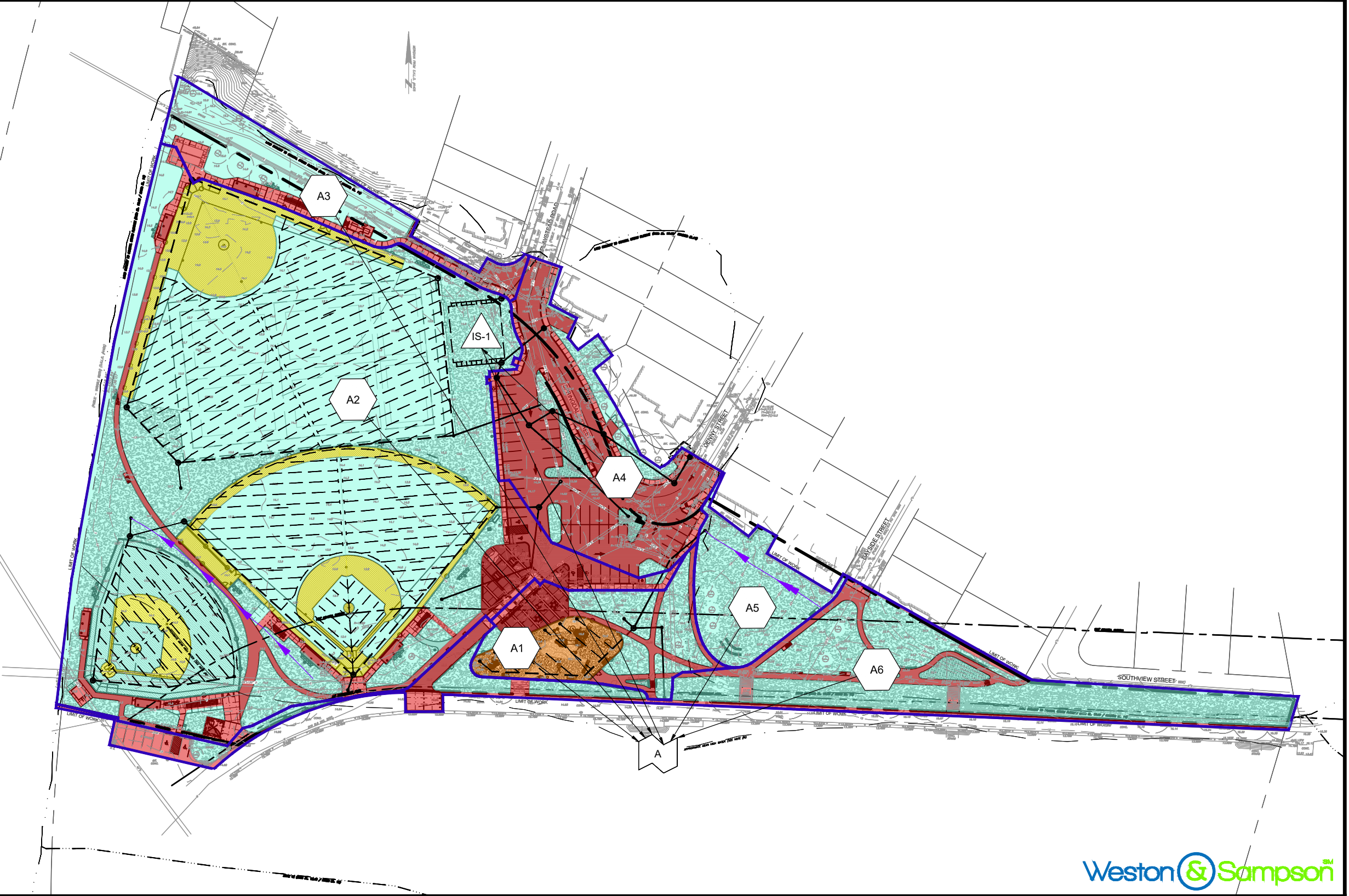
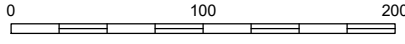
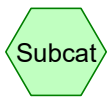
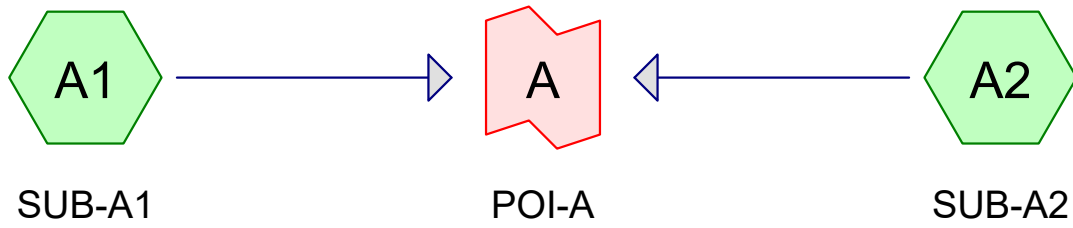

FIGURE 1
MCCONNELL PARK
BOSTON, MASSACHUSETTS
POST -DEVELOPMENT DRAINAGE MAP
SCALE: 1"=100'



McConnell Park
Boston, MA
Stormwater Discharge Summary Table
21-Oct-20

Analysis Point	24 Hr Storm	Peak Discharge (cfs)	
		Pre-Development	Post-Development
A	2yr	0.87	0.35
	10yr	6.00	3.88
	25yr	10.69	7.75
	100yr	18.98	17.58



Subcat



Reach

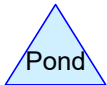

Pond



Link

HydroCAD-EX

Prepared by Weston & Sampson

HydroCAD® 10.10-3a s/n 00455 © 2020 HydroCAD Software Solutions LLC

Printed 10/20/2020

Page 2

Rainfall Events Listing

Event#	Event Name	Storm Type	Curve	Mode	Duration (hours)	B/B	Depth (inches)	AMC
1	2-Year	Type III 24-hr		Default	24.00	1	3.28	2
2	10-Year	Type III 24-hr		Default	24.00	1	5.16	2
3	25-Year	Type III 24-hr		Default	24.00	1	6.33	2
4	100-Year	Type III 24-hr		Default	24.00	1	8.14	2

HydroCAD-EX

Prepared by Weston & Sampson

HydroCAD® 10.10-3a s/n 00455 © 2020 HydroCAD Software Solutions LLC

Printed 10/20/2020

Page 3

Area Listing (all nodes)

Area (sq-ft)	CN	Description (subcatchment-numbers)
207,779	39	>75% Grass cover, Good, HSG A (A1, A2)
38,965	77	Fallow, bare soil, HSG A (A1)
58,865	98	Paved parking, HSG A (A1, A2)
305,609	55	TOTAL AREA

HydroCAD-EX

Prepared by Weston & Sampson

HydroCAD® 10.10-3a s/n 00455 © 2020 HydroCAD Software Solutions LLC

Printed 10/20/2020

Page 4

Soil Listing (all nodes)

Area (sq-ft)	Soil Group	Subcatchment Numbers
305,609	HSG A	A1, A2
0	HSG B	
0	HSG C	
0	HSG D	
0	Other	
305,609		TOTAL AREA

HydroCAD-EX

Prepared by Weston & Sampson

HydroCAD® 10.10-3a s/n 00455 © 2020 HydroCAD Software Solutions LLC

Printed 10/20/2020

Page 5

Ground Covers (all nodes)

HSG-A (sq-ft)	HSG-B (sq-ft)	HSG-C (sq-ft)	HSG-D (sq-ft)	Other (sq-ft)	Total (sq-ft)	Ground Cover
207,779	0	0	0	0	207,779	>75% Grass cover, Good
38,965	0	0	0	0	38,965	Fallow, bare soil
58,865	0	0	0	0	58,865	Paved parking
305,609	0	0	0	0	305,609	TOTAL AREA

HydroCAD-EX

Prepared by Weston & Sampson

HydroCAD® 10.10-3a s/n 00455 © 2020 HydroCAD Software Solutions LLC

Type III 24-hr 2-Year Rainfall=3.28"

Printed 10/20/2020

Page 6

Time span=0.00-72.00 hrs, dt=0.05 hrs, 1441 points
Runoff by SCS TR-20 method, UH=SCS, Weighted-CN
Reach routing by Dyn-Stor-Ind method - Pond routing by Dyn-Stor-Ind method

SubcatchmentA1: SUB-A1

Runoff Area=260,424 sf 18.83% Impervious Runoff Depth=0.31"
Flow Length=235' Tc=11.6 min CN=56 Runoff=0.81 cfs 6,623 cf

SubcatchmentA2: SUB-A2

Runoff Area=45,185 sf 21.76% Impervious Runoff Depth=0.19"
Tc=6.0 min CN=52 Runoff=0.06 cfs 726 cf

Link A: POI-A

Inflow=0.87 cfs 7,349 cf
Primary=0.87 cfs 7,349 cf

Total Runoff Area = 305,609 sf Runoff Volume = 7,349 cf Average Runoff Depth = 0.29"
80.74% Pervious = 246,744 sf 19.26% Impervious = 58,865 sf

Summary for Subcatchment A1: SUB-A1

Runoff = 0.81 cfs @ 12.38 hrs, Volume= 6,623 cf, Depth= 0.31"

Runoff by SCS TR-20 method, UH=SCS, Weighted-CN, Time Span= 0.00-72.00 hrs, dt= 0.05 hrs
 Type III 24-hr 2-Year Rainfall=3.28"

Area (sf)	CN	Description
49,035	98	Paved parking, HSG A
38,965	77	Fallow, bare soil, HSG A
172,424	39	>75% Grass cover, Good, HSG A
260,424	56	Weighted Average
211,389		81.17% Pervious Area
49,035		18.83% Impervious Area

Tc (min)	Length (feet)	Slope (ft/ft)	Velocity (ft/sec)	Capacity (cfs)	Description
9.7	50	0.0050	0.09		Sheet Flow, Sheet
1.9	185	0.0100	1.61		Grass: Short n= 0.150 P2= 3.28" Shallow Concentrated Flow, Shallow
11.6	235	Total			Unpaved Kv= 16.1 fps

Subcatchment A1: SUB-A1

Hydrograph

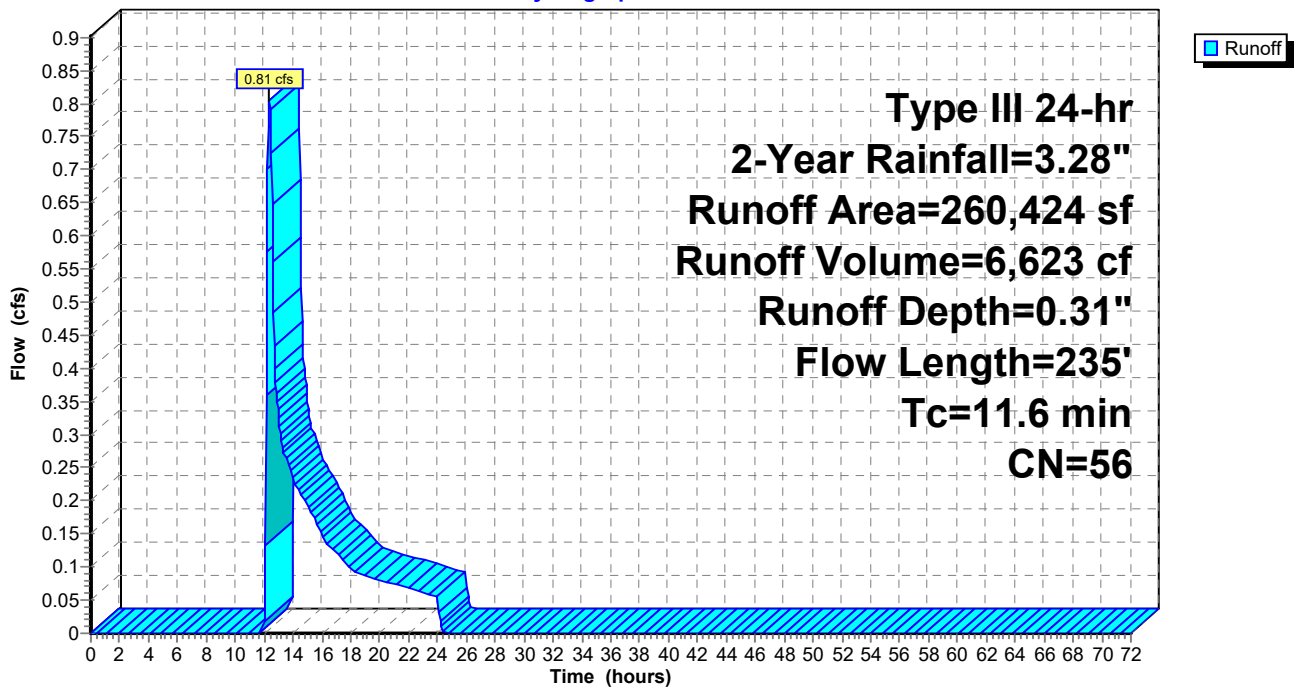

Summary for Subcatchment A2: SUB-A2

Runoff = 0.06 cfs @ 12.39 hrs, Volume= 726 cf, Depth= 0.19"

Runoff by SCS TR-20 method, UH=SCS, Weighted-CN, Time Span= 0.00-72.00 hrs, dt= 0.05 hrs
 Type III 24-hr 2-Year Rainfall=3.28"

Area (sf)	CN	Description
9,830	98	Paved parking, HSG A
35,355	39	>75% Grass cover, Good, HSG A
45,185	52	Weighted Average
35,355		78.24% Pervious Area
9,830		21.76% Impervious Area

Tc (min)	Length (feet)	Slope (ft/ft)	Velocity (ft/sec)	Capacity (cfs)	Description
6.0					Direct Entry, Min Tc=0.1 hrs

Subcatchment A2: SUB-A2

Hydrograph

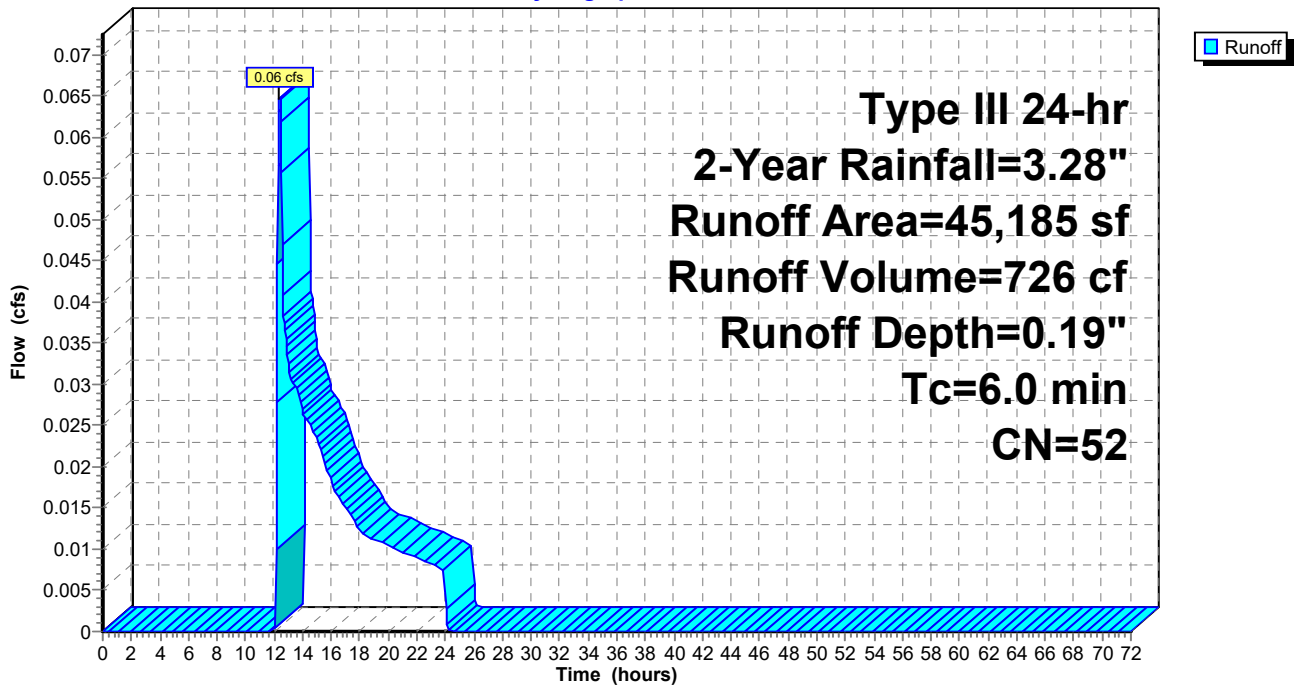

Summary for Link A: POI-A

Inflow Area = 305,609 sf, 19.26% Impervious, Inflow Depth = 0.29" for 2-Year event
Inflow = 0.87 cfs @ 12.38 hrs, Volume= 7,349 cf
Primary = 0.87 cfs @ 12.38 hrs, Volume= 7,349 cf, Atten= 0%, Lag= 0.0 min

Primary outflow = Inflow, Time Span= 0.00-72.00 hrs, dt= 0.05 hrs

Link A: POI-A

Hydrograph

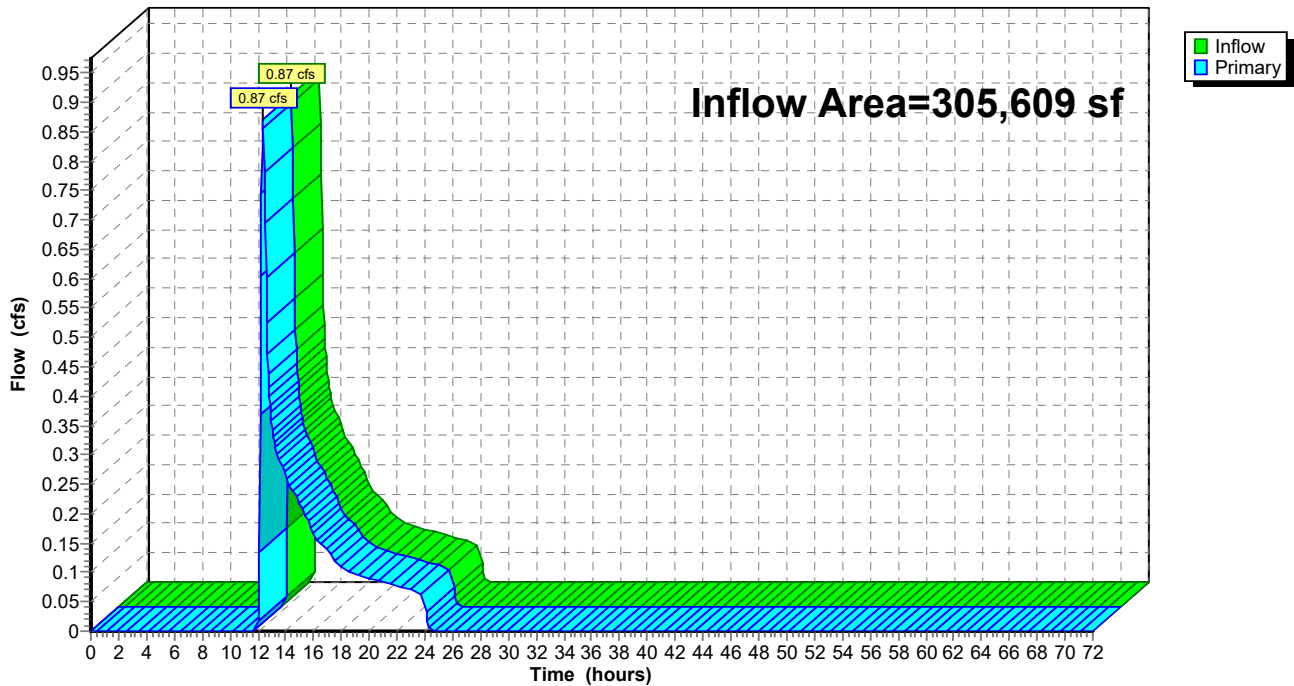

HydroCAD-EX

Prepared by Weston & Sampson

HydroCAD® 10.10-3a s/n 00455 © 2020 HydroCAD Software Solutions LLC

Type III 24-hr 10-Year Rainfall=5.16"

Printed 10/20/2020

Page 10

Time span=0.00-72.00 hrs, dt=0.05 hrs, 1441 points
Runoff by SCS TR-20 method, UH=SCS, Weighted-CN
Reach routing by Dyn-Stor-Ind method - Pond routing by Dyn-Stor-Ind method

SubcatchmentA1: SUB-A1

Runoff Area=260,424 sf 18.83% Impervious Runoff Depth=1.13"
Flow Length=235' Tc=11.6 min CN=56 Runoff=5.38 cfs 24,417 cf

SubcatchmentA2: SUB-A2

Runoff Area=45,185 sf 21.76% Impervious Runoff Depth=0.88"
Tc=6.0 min CN=52 Runoff=0.77 cfs 3,296 cf

Link A: POI-A

Inflow=6.00 cfs 27,714 cf
Primary=6.00 cfs 27,714 cf

Total Runoff Area = 305,609 sf Runoff Volume = 27,714 cf Average Runoff Depth = 1.09"
80.74% Pervious = 246,744 sf 19.26% Impervious = 58,865 sf

Summary for Subcatchment A1: SUB-A1

Runoff = 5.38 cfs @ 12.19 hrs, Volume= 24,417 cf, Depth= 1.13"

Runoff by SCS TR-20 method, UH=SCS, Weighted-CN, Time Span= 0.00-72.00 hrs, dt= 0.05 hrs
Type III 24-hr 10-Year Rainfall=5.16"

Area (sf)	CN	Description
49,035	98	Paved parking, HSG A
38,965	77	Fallow, bare soil, HSG A
172,424	39	>75% Grass cover, Good, HSG A
260,424	56	Weighted Average
211,389		81.17% Pervious Area
49,035		18.83% Impervious Area

Tc (min)	Length (feet)	Slope (ft/ft)	Velocity (ft/sec)	Capacity (cfs)	Description
9.7	50	0.0050	0.09		Sheet Flow, Sheet
1.9	185	0.0100	1.61		Grass: Short n= 0.150 P2= 3.28" Shallow Concentrated Flow, Shallow
11.6	235	Total			Unpaved Kv= 16.1 fps

Subcatchment A1: SUB-A1

Hydrograph

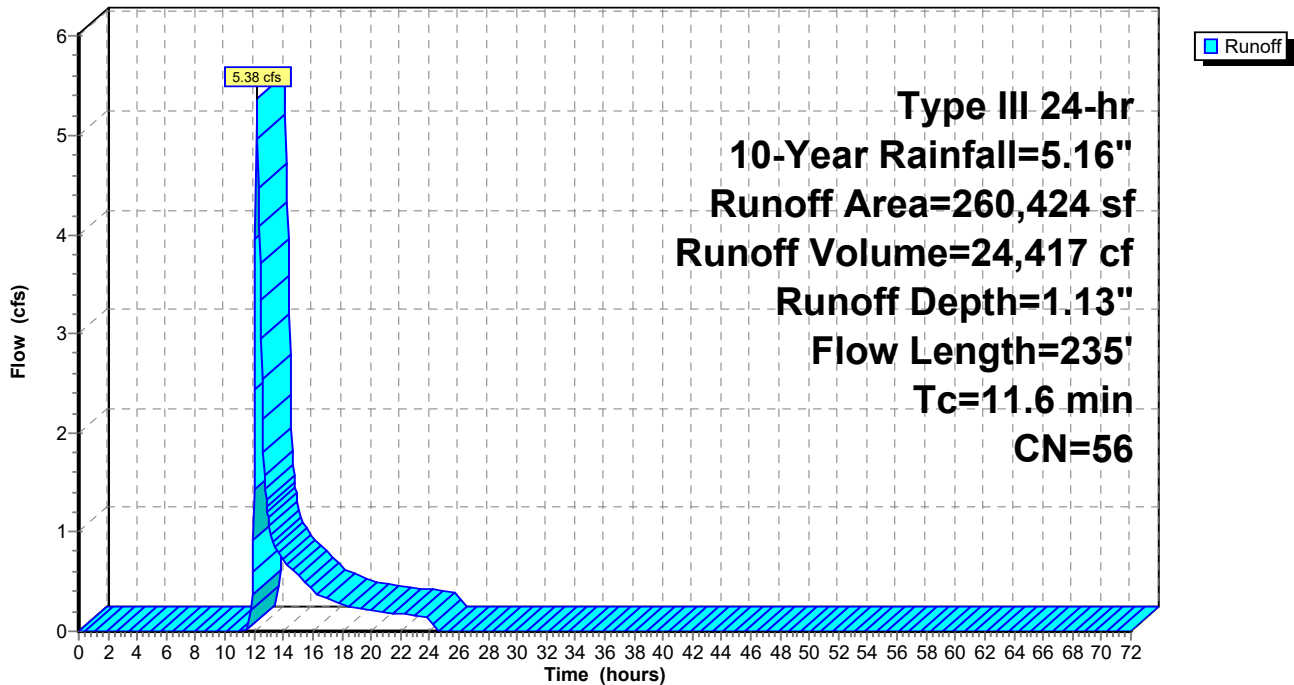

Summary for Subcatchment A2: SUB-A2

Runoff = 0.77 cfs @ 12.12 hrs, Volume= 3,296 cf, Depth= 0.88"

Runoff by SCS TR-20 method, UH=SCS, Weighted-CN, Time Span= 0.00-72.00 hrs, dt= 0.05 hrs
 Type III 24-hr 10-Year Rainfall=5.16"

Area (sf)	CN	Description
9,830	98	Paved parking, HSG A
35,355	39	>75% Grass cover, Good, HSG A
45,185	52	Weighted Average
35,355		78.24% Pervious Area
9,830		21.76% Impervious Area

Tc (min)	Length (feet)	Slope (ft/ft)	Velocity (ft/sec)	Capacity (cfs)	Description
6.0					Direct Entry, Min Tc=0.1 hrs

Subcatchment A2: SUB-A2

Hydrograph

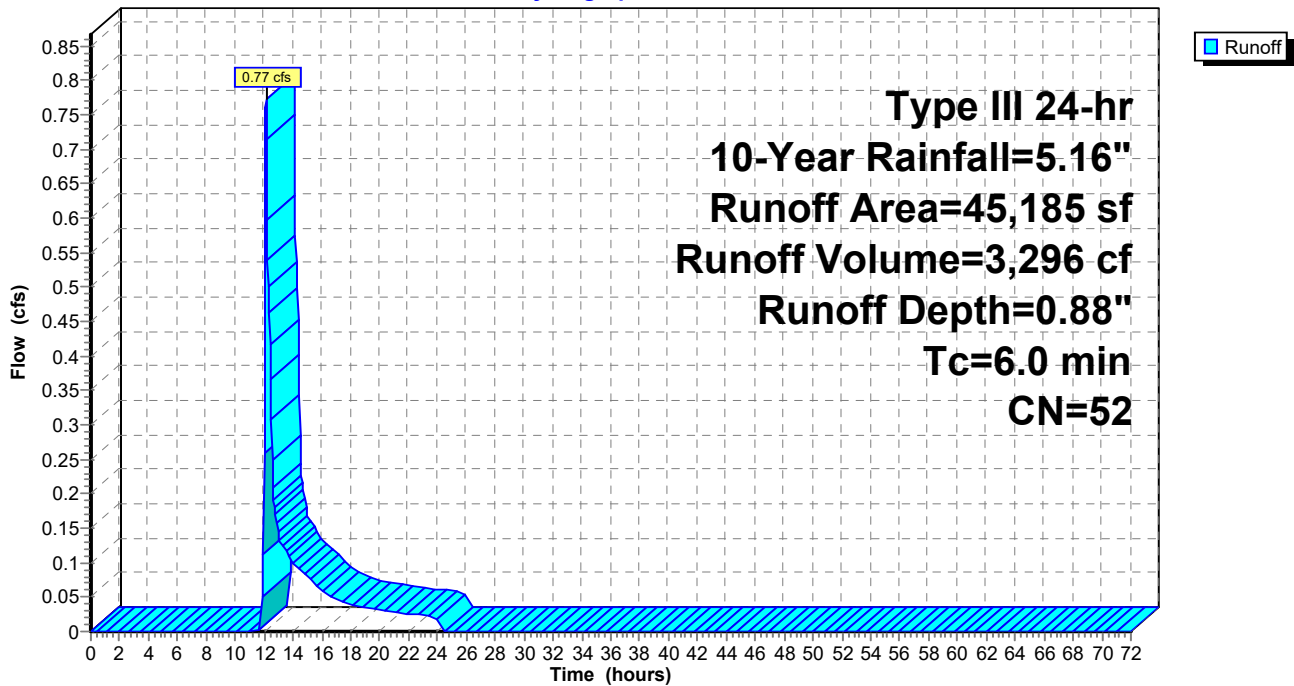

Summary for Link A: POI-A

Inflow Area = 305,609 sf, 19.26% Impervious, Inflow Depth = 1.09" for 10-Year event
Inflow = 6.00 cfs @ 12.18 hrs, Volume= 27,714 cf
Primary = 6.00 cfs @ 12.18 hrs, Volume= 27,714 cf, Atten= 0%, Lag= 0.0 min

Primary outflow = Inflow, Time Span= 0.00-72.00 hrs, dt= 0.05 hrs

Link A: POI-A

Hydrograph

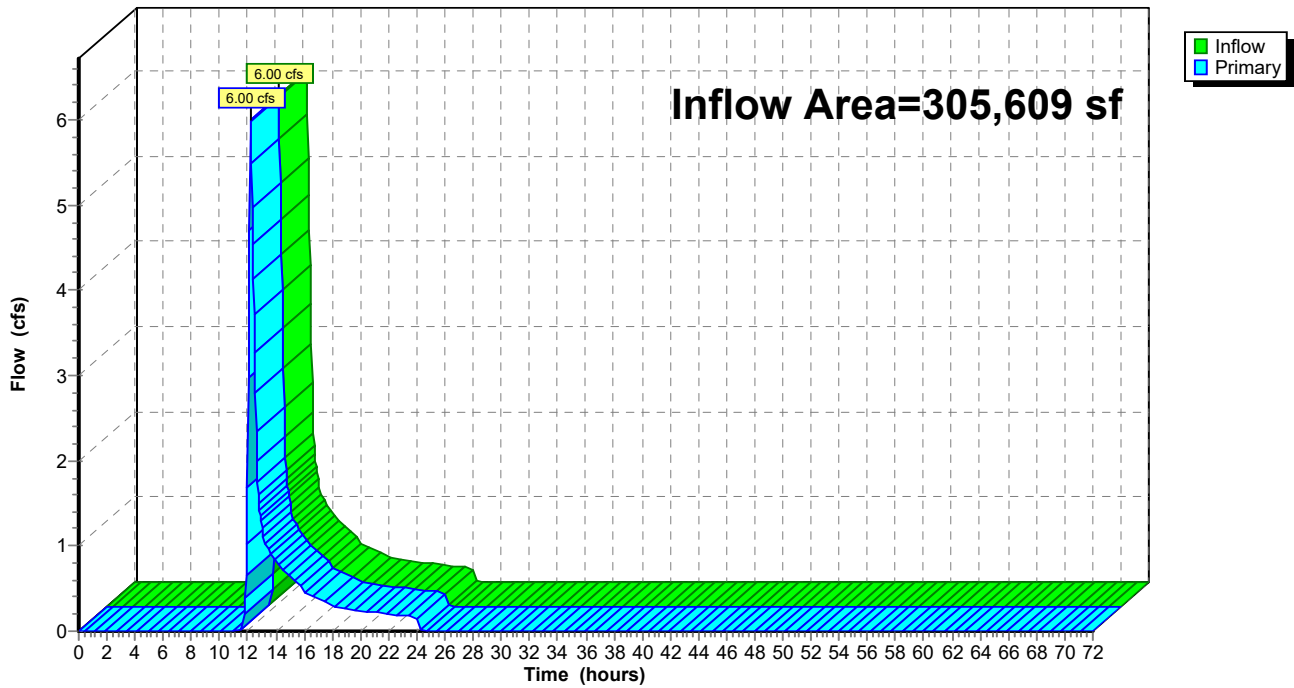

HydroCAD-EX

Prepared by Weston & Sampson

HydroCAD® 10.10-3a s/n 00455 © 2020 HydroCAD Software Solutions LLC

Type III 24-hr 25-Year Rainfall=6.33"

Printed 10/20/2020

Page 14

Time span=0.00-72.00 hrs, dt=0.05 hrs, 1441 points
Runoff by SCS TR-20 method, UH=SCS, Weighted-CN
Reach routing by Dyn-Stor-Ind method - Pond routing by Dyn-Stor-Ind method

SubcatchmentA1: SUB-A1

Runoff Area=260,424 sf 18.83% Impervious Runoff Depth=1.79"
Flow Length=235' Tc=11.6 min CN=56 Runoff=9.39 cfs 38,953 cf

SubcatchmentA2: SUB-A2

Runoff Area=45,185 sf 21.76% Impervious Runoff Depth=1.47"
Tc=6.0 min CN=52 Runoff=1.52 cfs 5,520 cf

Link A: POI-A

Inflow=10.69 cfs 44,473 cf
Primary=10.69 cfs 44,473 cf

Total Runoff Area = 305,609 sf Runoff Volume = 44,473 cf Average Runoff Depth = 1.75"
80.74% Pervious = 246,744 sf 19.26% Impervious = 58,865 sf

Summary for Subcatchment A1: SUB-A1

Runoff = 9.39 cfs @ 12.18 hrs, Volume= 38,953 cf, Depth= 1.79"

Runoff by SCS TR-20 method, UH=SCS, Weighted-CN, Time Span= 0.00-72.00 hrs, dt= 0.05 hrs
Type III 24-hr 25-Year Rainfall=6.33"

Area (sf)	CN	Description
49,035	98	Paved parking, HSG A
38,965	77	Fallow, bare soil, HSG A
172,424	39	>75% Grass cover, Good, HSG A
260,424	56	Weighted Average
211,389		81.17% Pervious Area
49,035		18.83% Impervious Area

Tc (min)	Length (feet)	Slope (ft/ft)	Velocity (ft/sec)	Capacity (cfs)	Description
9.7	50	0.0050	0.09		Sheet Flow, Sheet
1.9	185	0.0100	1.61		Grass: Short n= 0.150 P2= 3.28" Shallow Concentrated Flow, Shallow
11.6	235	Total			Unpaved Kv= 16.1 fps

Subcatchment A1: SUB-A1

Hydrograph

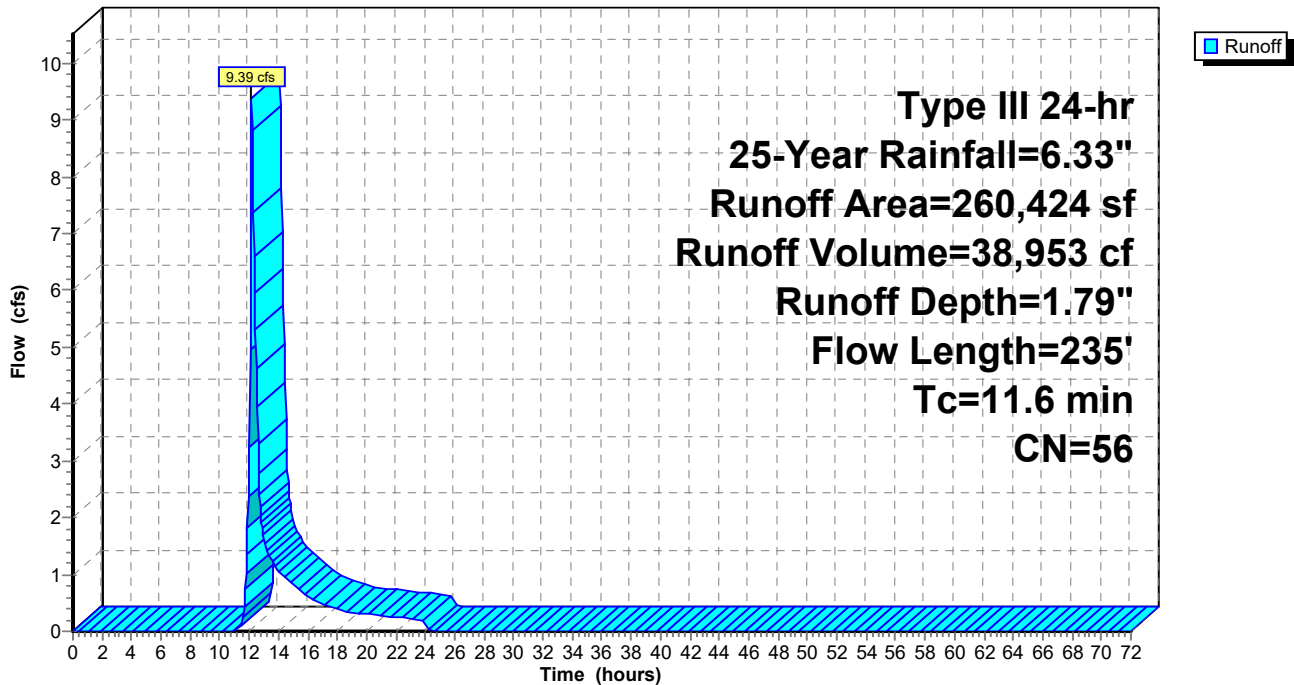

Summary for Subcatchment A2: SUB-A2

Runoff = 1.52 cfs @ 12.11 hrs, Volume= 5,520 cf, Depth= 1.47"

Runoff by SCS TR-20 method, UH=SCS, Weighted-CN, Time Span= 0.00-72.00 hrs, dt= 0.05 hrs
 Type III 24-hr 25-Year Rainfall=6.33"

Area (sf)	CN	Description
9,830	98	Paved parking, HSG A
35,355	39	>75% Grass cover, Good, HSG A
45,185	52	Weighted Average
35,355		78.24% Pervious Area
9,830		21.76% Impervious Area

Tc (min)	Length (feet)	Slope (ft/ft)	Velocity (ft/sec)	Capacity (cfs)	Description
6.0					Direct Entry, Min Tc=0.1 hrs

Subcatchment A2: SUB-A2

Hydrograph

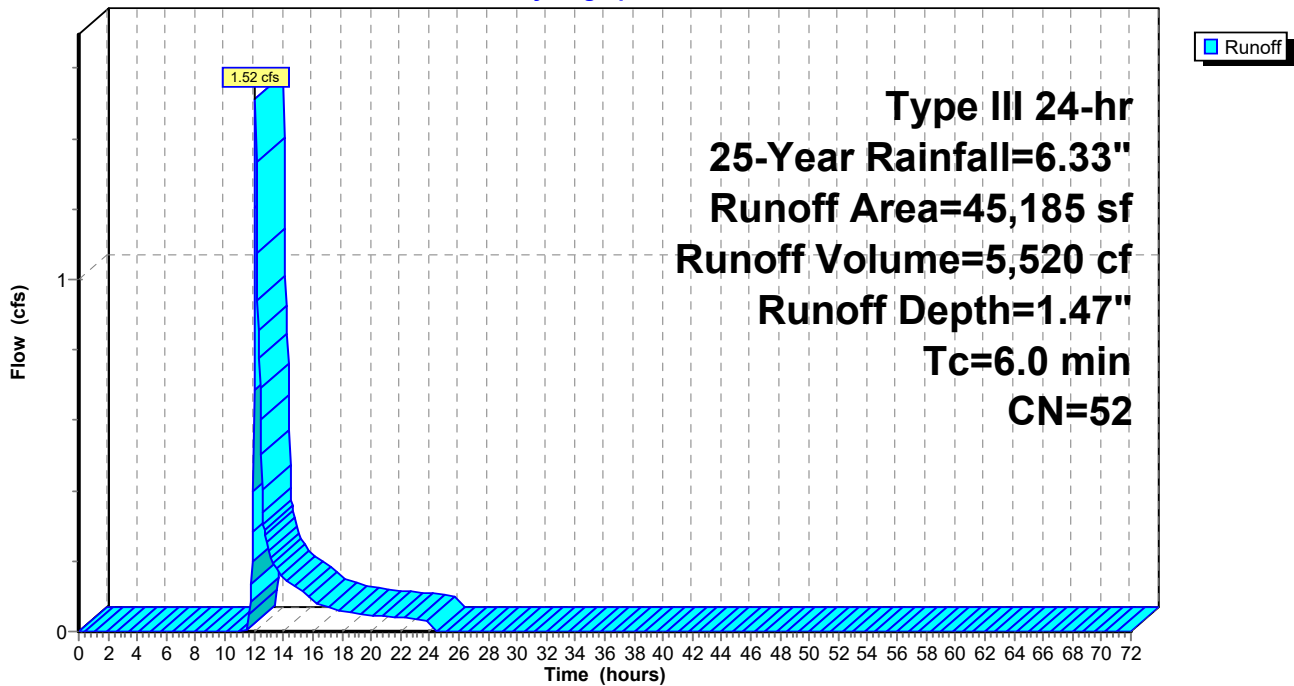

Summary for Link A: POI-A

Inflow Area = 305,609 sf, 19.26% Impervious, Inflow Depth = 1.75" for 25-Year event
Inflow = 10.69 cfs @ 12.17 hrs, Volume= 44,473 cf
Primary = 10.69 cfs @ 12.17 hrs, Volume= 44,473 cf, Atten= 0%, Lag= 0.0 min

Primary outflow = Inflow, Time Span= 0.00-72.00 hrs, dt= 0.05 hrs

Link A: POI-A

Hydrograph

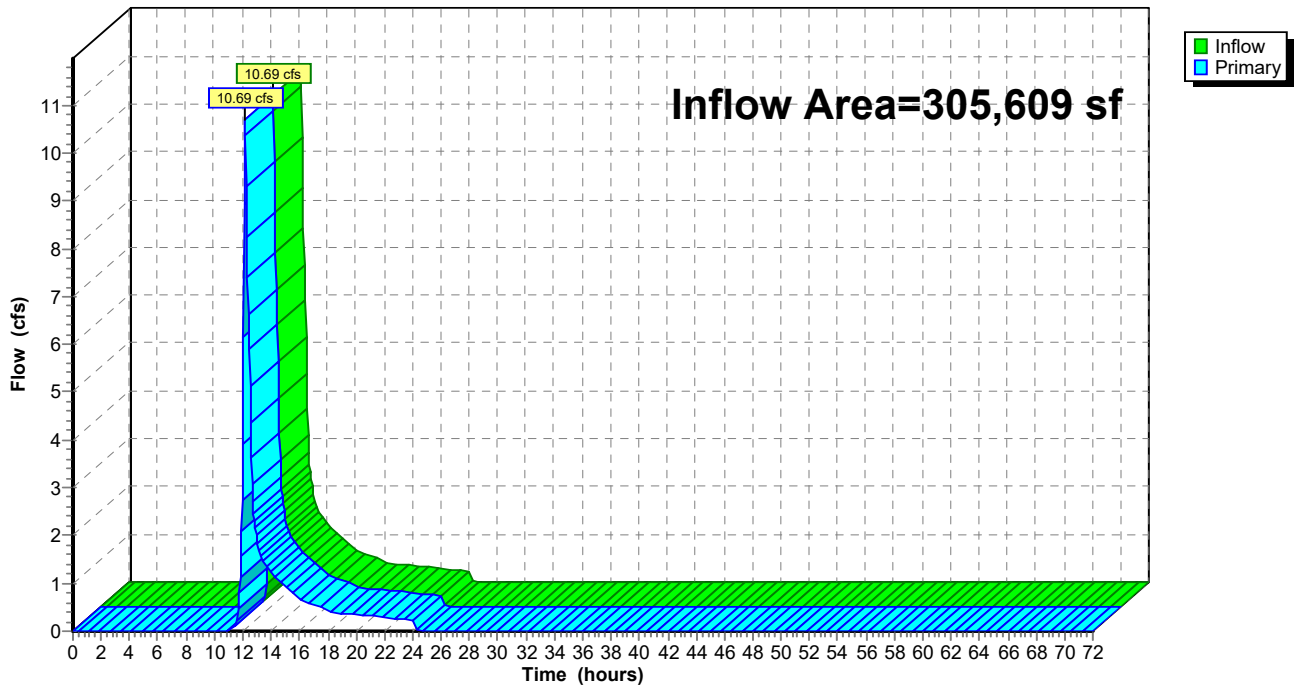

HydroCAD-EX*Type III 24-hr 100-Year Rainfall=8.14"*

Prepared by Weston & Sampson

Printed 10/20/2020

HydroCAD® 10.10-3a s/n 00455 © 2020 HydroCAD Software Solutions LLC

Page 18

Time span=0.00-72.00 hrs, dt=0.05 hrs, 1441 points
Runoff by SCS TR-20 method, UH=SCS, Weighted-CN
Reach routing by Dyn-Stor-Ind method - Pond routing by Dyn-Stor-Ind method

SubcatchmentA1: SUB-A1

Runoff Area=260,424 sf 18.83% Impervious Runoff Depth=2.99"
Flow Length=235' Tc=11.6 min CN=56 Runoff=16.70 cfs 64,909 cf

SubcatchmentA2: SUB-A2

Runoff Area=45,185 sf 21.76% Impervious Runoff Depth=2.55"
Tc=6.0 min CN=52 Runoff=2.87 cfs 9,608 cf

Link A: POI-A

Inflow=18.98 cfs 74,517 cf
Primary=18.98 cfs 74,517 cf

Total Runoff Area = 305,609 sf Runoff Volume = 74,517 cf Average Runoff Depth = 2.93"
80.74% Pervious = 246,744 sf 19.26% Impervious = 58,865 sf

Summary for Subcatchment A1: SUB-A1

Runoff = 16.70 cfs @ 12.17 hrs, Volume= 64,909 cf, Depth= 2.99"

Runoff by SCS TR-20 method, UH=SCS, Weighted-CN, Time Span= 0.00-72.00 hrs, dt= 0.05 hrs
 Type III 24-hr 100-Year Rainfall=8.14"

Area (sf)	CN	Description
49,035	98	Paved parking, HSG A
38,965	77	Fallow, bare soil, HSG A
172,424	39	>75% Grass cover, Good, HSG A
260,424	56	Weighted Average
211,389		81.17% Pervious Area
49,035		18.83% Impervious Area

Tc (min)	Length (feet)	Slope (ft/ft)	Velocity (ft/sec)	Capacity (cfs)	Description
9.7	50	0.0050	0.09		Sheet Flow, Sheet
1.9	185	0.0100	1.61		Grass: Short n= 0.150 P2= 3.28" Shallow Concentrated Flow, Shallow
11.6	235	Total			Unpaved Kv= 16.1 fps

Subcatchment A1: SUB-A1

Hydrograph

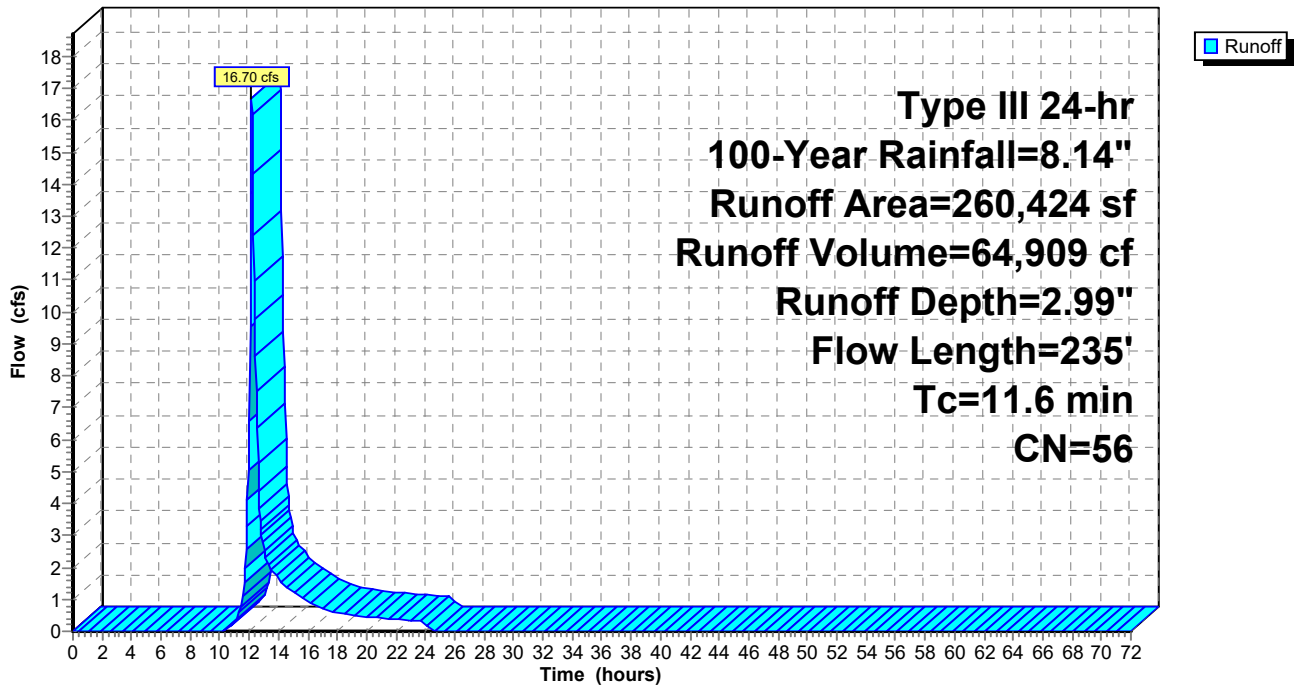

Summary for Subcatchment A2: SUB-A2

Runoff = 2.87 cfs @ 12.10 hrs, Volume= 9,608 cf, Depth= 2.55"

Runoff by SCS TR-20 method, UH=SCS, Weighted-CN, Time Span= 0.00-72.00 hrs, dt= 0.05 hrs
 Type III 24-hr 100-Year Rainfall=8.14"

Area (sf)	CN	Description
9,830	98	Paved parking, HSG A
35,355	39	>75% Grass cover, Good, HSG A
45,185	52	Weighted Average
35,355		78.24% Pervious Area
9,830		21.76% Impervious Area

Tc (min)	Length (feet)	Slope (ft/ft)	Velocity (ft/sec)	Capacity (cfs)	Description
6.0					Direct Entry, Min Tc=0.1 hrs

Subcatchment A2: SUB-A2

Hydrograph

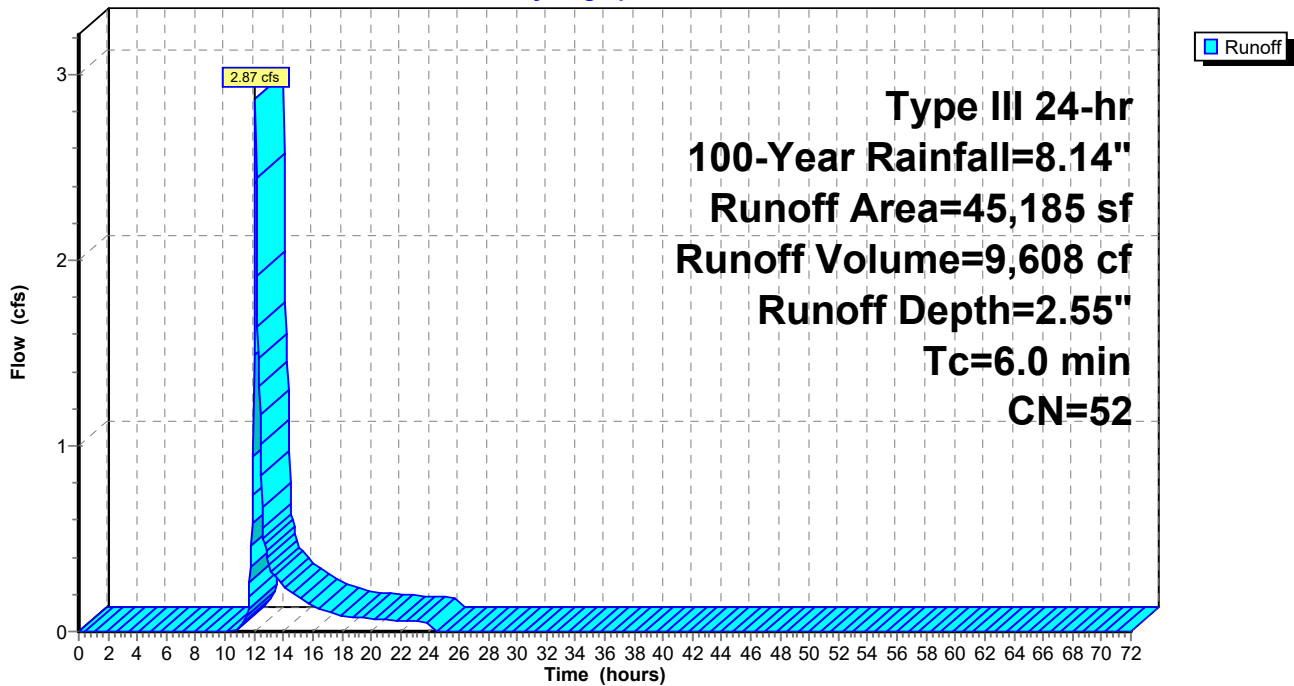

Summary for Link A: POI-A

Inflow Area = 305,609 sf, 19.26% Impervious, Inflow Depth = 2.93" for 100-Year event
Inflow = 18.98 cfs @ 12.16 hrs, Volume= 74,517 cf
Primary = 18.98 cfs @ 12.16 hrs, Volume= 74,517 cf, Atten= 0%, Lag= 0.0 min

Primary outflow = Inflow, Time Span= 0.00-72.00 hrs, dt= 0.05 hrs

Link A: POI-A

Hydrograph

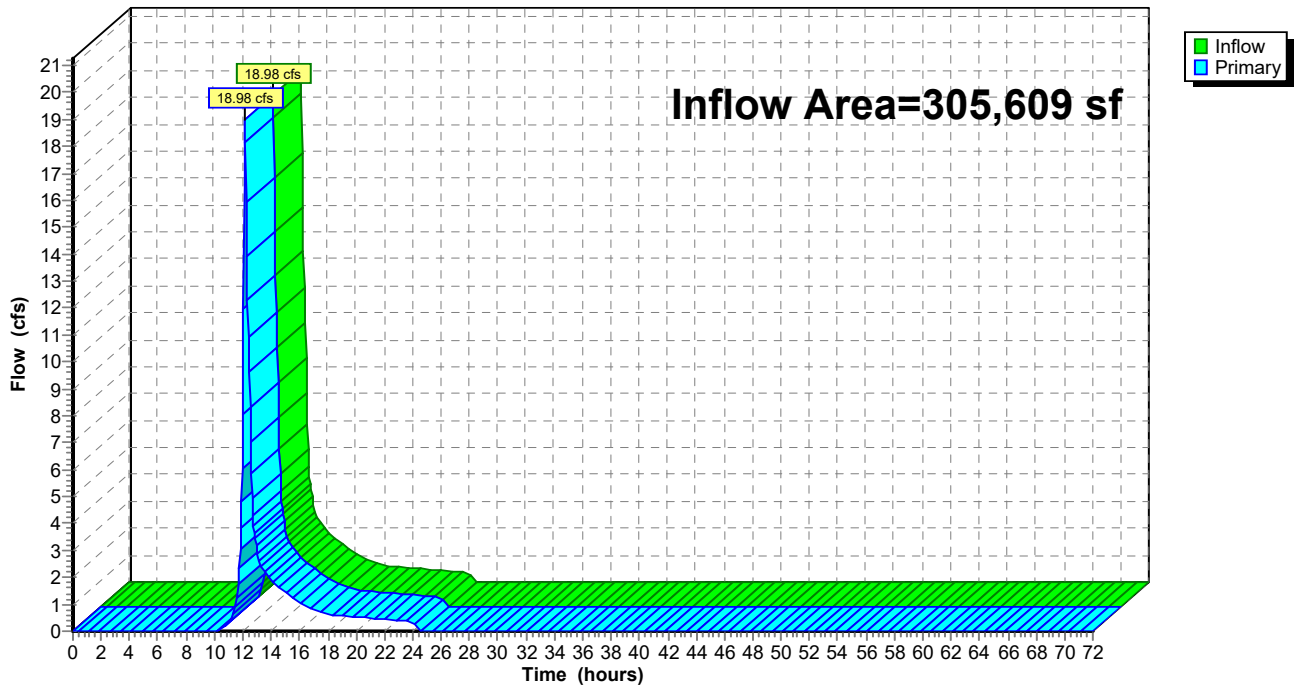

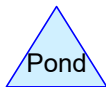
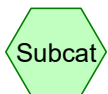
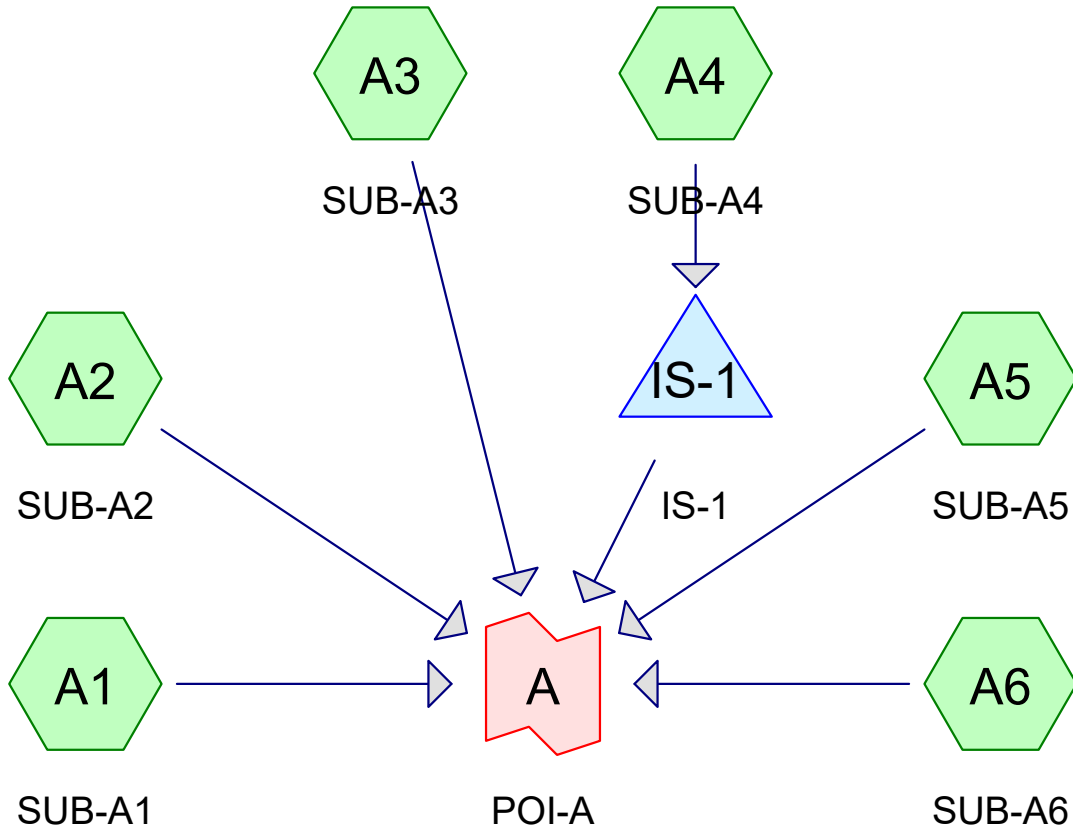

Routing Diagram for HydroCAD-PR
 Prepared by Weston & Sampson, Printed 10/20/2020
 HydroCAD® 10.10-3a s/n 00455 © 2020 HydroCAD Software Solutions LLC

HydroCAD-PR

Prepared by Weston & Sampson

HydroCAD® 10.10-3a s/n 00455 © 2020 HydroCAD Software Solutions LLC

Printed 10/20/2020

Page 2

Rainfall Events Listing

Event#	Event Name	Storm Type	Curve	Mode	Duration (hours)	B/B	Depth (inches)	AMC
1	2-Year	Type III 24-hr		Default	24.00	1	3.28	2
2	10-Year	Type III 24-hr		Default	24.00	1	5.16	2
3	25-Year	Type III 24-hr		Default	24.00	1	6.33	2
4	100-Year	Type III 24-hr		Default	24.00	1	8.14	2

HydroCAD-PR

Prepared by Weston & Sampson

HydroCAD® 10.10-3a s/n 00455 © 2020 HydroCAD Software Solutions LLC

Printed 10/20/2020

Page 3

Area Listing (all nodes)

Area (sq-ft)	CN	Description (subcatchment-numbers)
204,882	39	>75% Grass cover, Good, HSG A (A1, A2, A3, A4, A5, A6)
25,277	77	Fallow, bare soil, HSG A (A2)
69,383	98	Paved parking, HSG A (A1, A2, A3, A4, A6)
6,067	39	Rubber play assume CN of underlying soils (A1)
305,609	56	TOTAL AREA

HydroCAD-PR

Prepared by Weston & Sampson

HydroCAD® 10.10-3a s/n 00455 © 2020 HydroCAD Software Solutions LLC

Printed 10/20/2020

Page 4

Soil Listing (all nodes)

Area (sq-ft)	Soil Group	Subcatchment Numbers
299,542	HSG A	A1, A2, A3, A4, A5, A6
0	HSG B	
0	HSG C	
0	HSG D	
6,067	Other	A1
305,609		TOTAL AREA

HydroCAD-PR

Prepared by Weston & Sampson

HydroCAD® 10.10-3a s/n 00455 © 2020 HydroCAD Software Solutions LLC

Printed 10/20/2020

Page 5

Ground Covers (all nodes)

HSG-A (sq-ft)	HSG-B (sq-ft)	HSG-C (sq-ft)	HSG-D (sq-ft)	Other (sq-ft)	Total (sq-ft)	Ground Cover
204,882	0	0	0	0	204,882	>75% Grass cover, Good
25,277	0	0	0	0	25,277	Fallow, bare soil
69,383	0	0	0	0	69,383	Paved parking
0	0	0	0	6,067	6,067	Rubber play assume CN of underlying soils
299,542	0	0	0	6,067	305,609	TOTAL AREA

HydroCAD-PR

Prepared by Weston & Sampson

HydroCAD® 10.10-3a s/n 00455 © 2020 HydroCAD Software Solutions LLC

Printed 10/20/2020

Page 6

Pipe Listing (all nodes)

Line#	Node Number	In-Invert (feet)	Out-Invert (feet)	Length (feet)	Slope (ft/ft)	n	Diam/Width (inches)	Height (inches)	Inside-Fill (inches)
1	IS-1	8.10	8.05	3.0	0.0167	0.013	12.0	0.0	0.0

HydroCAD-PR

Prepared by Weston & Sampson

HydroCAD® 10.10-3a s/n 00455 © 2020 HydroCAD Software Solutions LLC

Type III 24-hr 2-Year Rainfall=3.28"

Printed 10/20/2020

Page 7

Time span=0.00-72.00 hrs, dt=0.01 hrs, 7201 points
 Runoff by SCS TR-20 method, UH=SCS, Weighted-CN
 Reach routing by Dyn-Stor-Ind method - Pond routing by Dyn-Stor-Ind method

SubcatchmentA1: SUB-A1 Runoff Area=18,765 sf 27.70% Impervious Runoff Depth=0.27"
 Tc=6.0 min CN=55 Runoff=0.05 cfs 430 cf

SubcatchmentA2: SUB-A2 Runoff Area=182,737 sf 10.49% Impervious Runoff Depth=0.15"
 Flow Length=232' Tc=10.0 min CN=50 Runoff=0.13 cfs 2,212 cf

SubcatchmentA3: SUB-A3 Runoff Area=16,685 sf 31.77% Impervious Runoff Depth=0.37"
 Tc=6.0 min CN=58 Runoff=0.08 cfs 514 cf

SubcatchmentA4: SUB-A4 Runoff Area=32,298 sf 81.57% Impervious Runoff Depth=1.99"
 Tc=6.0 min CN=87 Runoff=1.72 cfs 5,345 cf

SubcatchmentA5: SUB-A5 Runoff Area=12,207 sf 0.00% Impervious Runoff Depth=0.00"
 Tc=6.0 min CN=39 Runoff=0.00 cfs 1 cf

SubcatchmentA6: SUB-A6 Runoff Area=42,917 sf 31.17% Impervious Runoff Depth=0.34"
 Tc=6.0 min CN=57 Runoff=0.17 cfs 1,205 cf

Pond IS-1: IS-1 Peak Elev=10.18' Storage=1,963 cf Inflow=1.72 cfs 5,345 cf
 Discarded=0.18 cfs 5,345 cf Primary=0.00 cfs 0 cf Outflow=0.18 cfs 5,345 cf

Link A: POI-A Inflow=0.35 cfs 4,362 cf
 Primary=0.35 cfs 4,362 cf

Total Runoff Area = 305,609 sf Runoff Volume = 9,707 cf Average Runoff Depth = 0.38"
77.30% Pervious = 236,226 sf 22.70% Impervious = 69,383 sf

Summary for Subcatchment A1: SUB-A1

Runoff = 0.05 cfs @ 12.32 hrs, Volume= 430 cf, Depth= 0.27"

Runoff by SCS TR-20 method, UH=SCS, Weighted-CN, Time Span= 0.00-72.00 hrs, dt= 0.01 hrs
 Type III 24-hr 2-Year Rainfall=3.28"

Area (sf)	CN	Description
5,198	98	Paved parking, HSG A
7,500	39	>75% Grass cover, Good, HSG A
* 6,067	39	Rubber play assume CN of underlying soils
18,765	55	Weighted Average
13,567		72.30% Pervious Area
5,198		27.70% Impervious Area

Tc (min)	Length (feet)	Slope (ft/ft)	Velocity (ft/sec)	Capacity (cfs)	Description
6.0					Direct Entry, Min Tc = 0.1hrs

Subcatchment A1: SUB-A1

Hydrograph

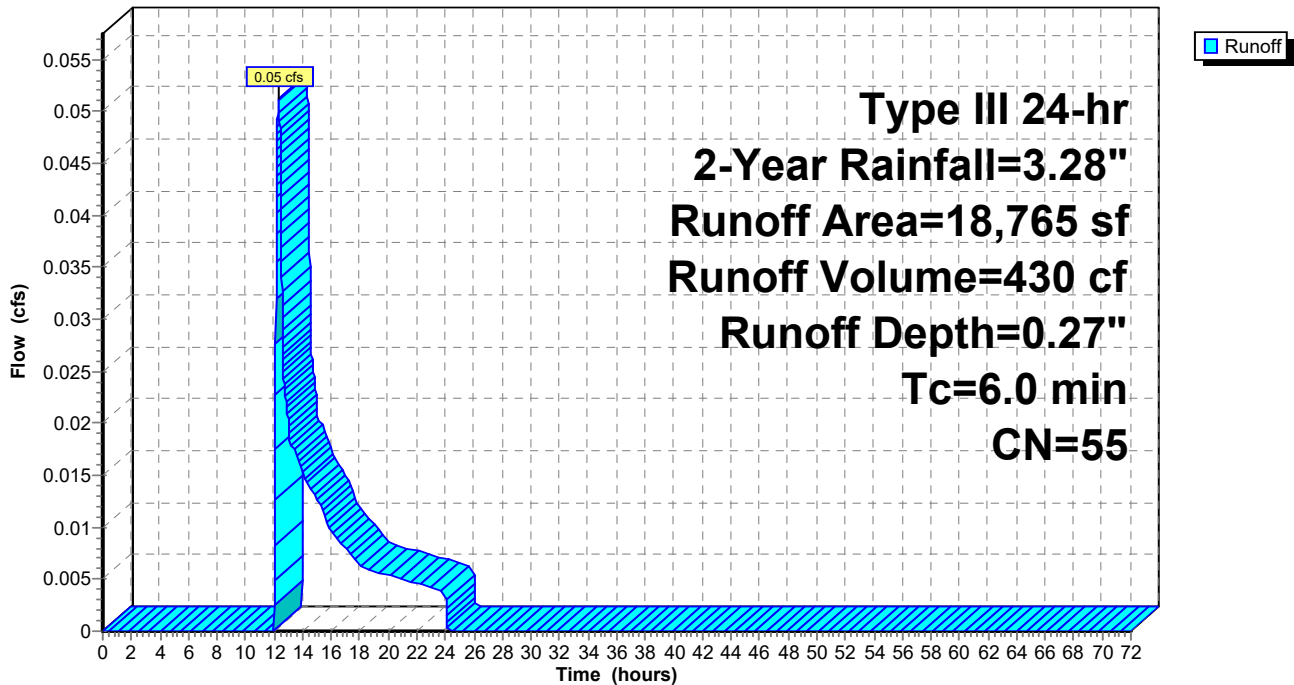

Summary for Subcatchment A2: SUB-A2

Runoff = 0.13 cfs @ 12.52 hrs, Volume= 2,212 cf, Depth= 0.15"

Runoff by SCS TR-20 method, UH=SCS, Weighted-CN, Time Span= 0.00-72.00 hrs, dt= 0.01 hrs
Type III 24-hr 2-Year Rainfall=3.28"

Area (sf)	CN	Description
19,160	98	Paved parking, HSG A
138,300	39	>75% Grass cover, Good, HSG A
25,277	77	Fallow, bare soil, HSG A
182,737	50	Weighted Average
163,577		89.51% Pervious Area
19,160		10.49% Impervious Area

Tc (min)	Length (feet)	Slope (ft/ft)	Velocity (ft/sec)	Capacity (cfs)	Description
9.0	50	0.0060	0.09		Sheet Flow, Sheet Grass: Short n= 0.150 P2= 3.28"
0.2	18	0.0060	1.25		Shallow Concentrated Flow, Shallow 1 Unpaved Kv= 16.1 fps
0.2	85	0.0870	5.99		Shallow Concentrated Flow, Shallow 2 Paved Kv= 20.3 fps
0.6	79	0.0190	2.22		Shallow Concentrated Flow, Shallow 3 Unpaved Kv= 16.1 fps
10.0	232	Total			

Subcatchment A2: SUB-A2

Hydrograph

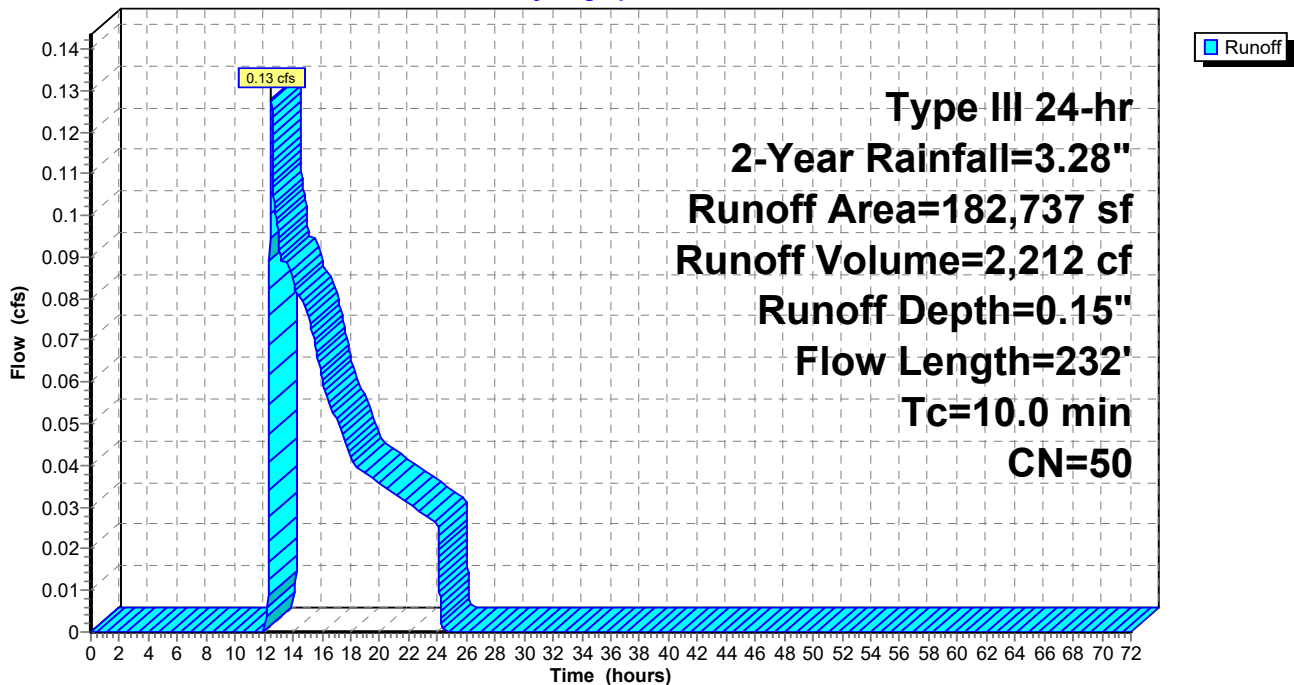

Summary for Subcatchment A3: SUB-A3

Runoff = 0.08 cfs @ 12.14 hrs, Volume= 514 cf, Depth= 0.37"

Runoff by SCS TR-20 method, UH=SCS, Weighted-CN, Time Span= 0.00-72.00 hrs, dt= 0.01 hrs
Type III 24-hr 2-Year Rainfall=3.28"

Area (sf)	CN	Description
5,301	98	Paved parking, HSG A
11,384	39	>75% Grass cover, Good, HSG A
16,685	58	Weighted Average
11,384		68.23% Pervious Area
5,301		31.77% Impervious Area

Tc (min)	Length (feet)	Slope (ft/ft)	Velocity (ft/sec)	Capacity (cfs)	Description
6.0					Direct Entry, Min Tc = 0.1hrs

Subcatchment A3: SUB-A3

Hydrograph

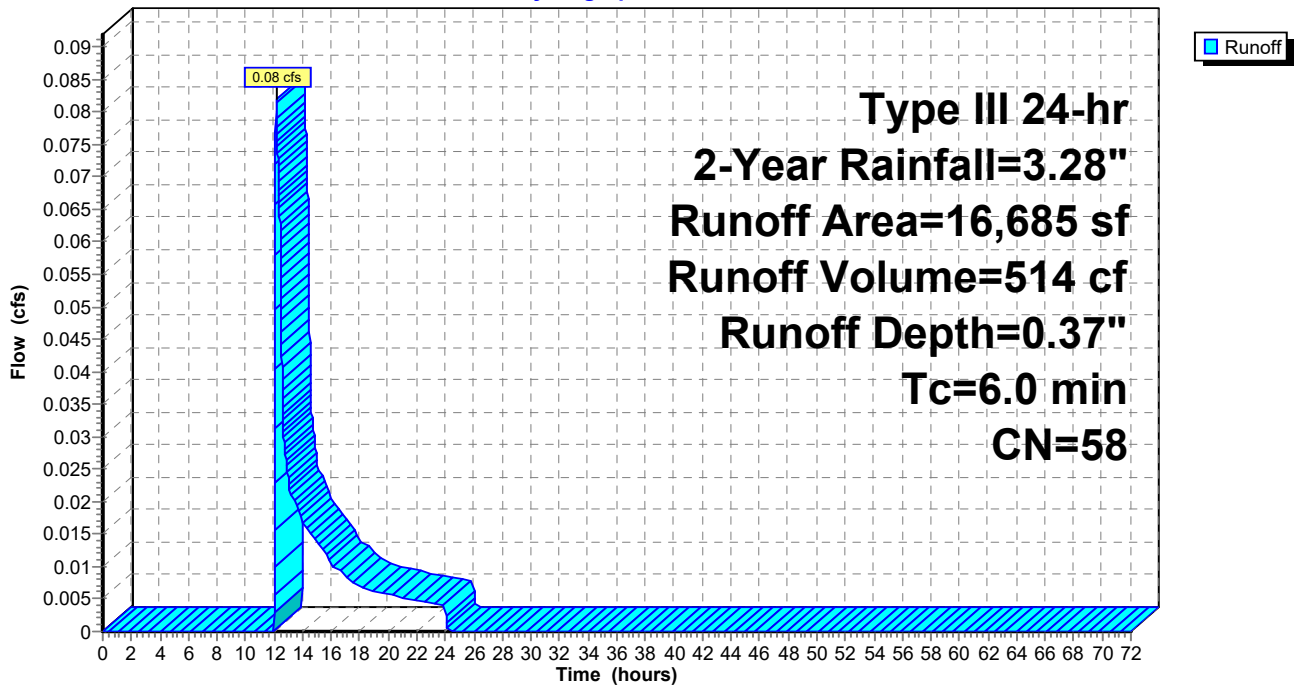

Summary for Subcatchment A4: SUB-A4

Runoff = 1.72 cfs @ 12.09 hrs, Volume= 5,345 cf, Depth= 1.99"

Runoff by SCS TR-20 method, UH=SCS, Weighted-CN, Time Span= 0.00-72.00 hrs, dt= 0.01 hrs
 Type III 24-hr 2-Year Rainfall=3.28"

Area (sf)	CN	Description
26,345	98	Paved parking, HSG A
5,953	39	>75% Grass cover, Good, HSG A
32,298	87	Weighted Average
5,953		18.43% Pervious Area
26,345		81.57% Impervious Area

Tc (min)	Length (feet)	Slope (ft/ft)	Velocity (ft/sec)	Capacity (cfs)	Description
6.0					Direct Entry, Min Tc = 0.1hrs

Subcatchment A4: SUB-A4

Hydrograph

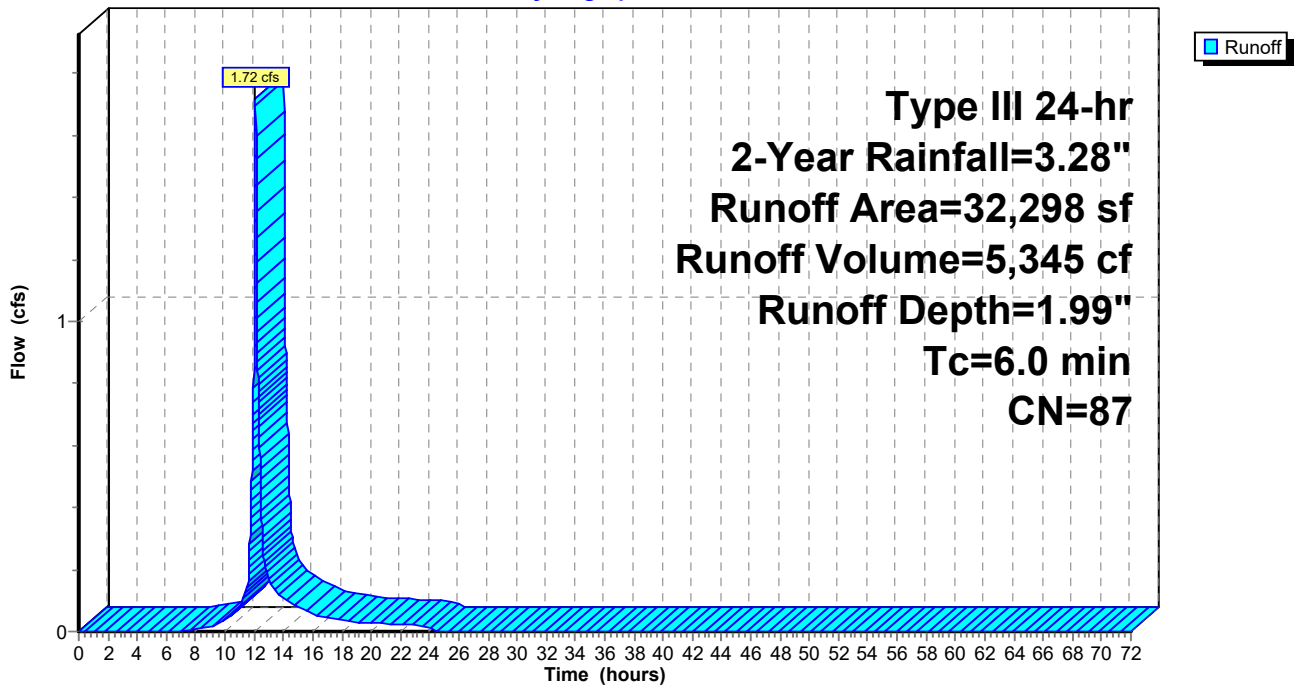

Summary for Subcatchment A5: SUB-A5

Runoff = 0.00 cfs @ 24.01 hrs, Volume= 1 cf, Depth= 0.00"

Runoff by SCS TR-20 method, UH=SCS, Weighted-CN, Time Span= 0.00-72.00 hrs, dt= 0.01 hrs
 Type III 24-hr 2-Year Rainfall=3.28"

Area (sf)	CN	Description
12,207	39	>75% Grass cover, Good, HSG A
12,207		100.00% Pervious Area

Tc (min)	Length (feet)	Slope (ft/ft)	Velocity (ft/sec)	Capacity (cfs)	Description
6.0					Direct Entry, Min Tc = 0.1hrs

Subcatchment A5: SUB-A5

Hydrograph

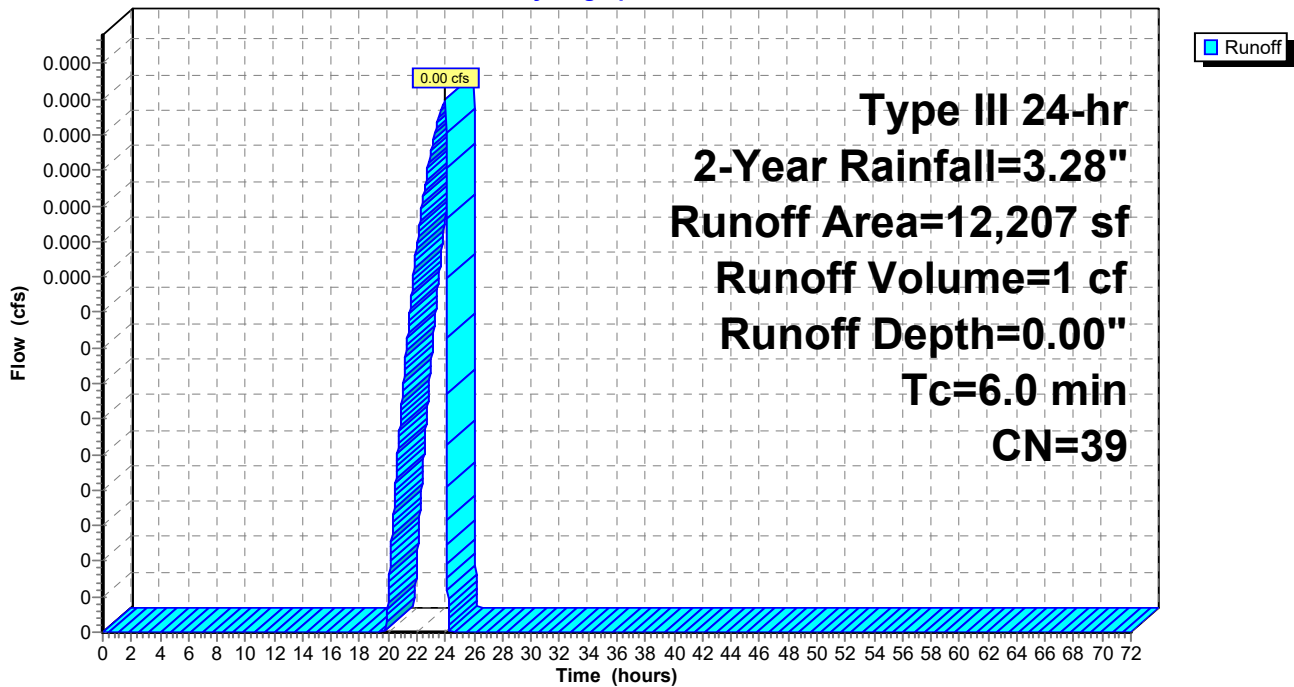

Summary for Subcatchment A6: SUB-A6

Runoff = 0.17 cfs @ 12.15 hrs, Volume= 1,205 cf, Depth= 0.34"

Runoff by SCS TR-20 method, UH=SCS, Weighted-CN, Time Span= 0.00-72.00 hrs, dt= 0.01 hrs
Type III 24-hr 2-Year Rainfall=3.28"

Area (sf)	CN	Description
13,379	98	Paved parking, HSG A
29,538	39	>75% Grass cover, Good, HSG A
42,917	57	Weighted Average
29,538		68.83% Pervious Area
13,379		31.17% Impervious Area

Tc (min)	Length (feet)	Slope (ft/ft)	Velocity (ft/sec)	Capacity (cfs)	Description
6.0					Direct Entry, Min Tc = 0.1hrs

Subcatchment A6: SUB-A6

Hydrograph

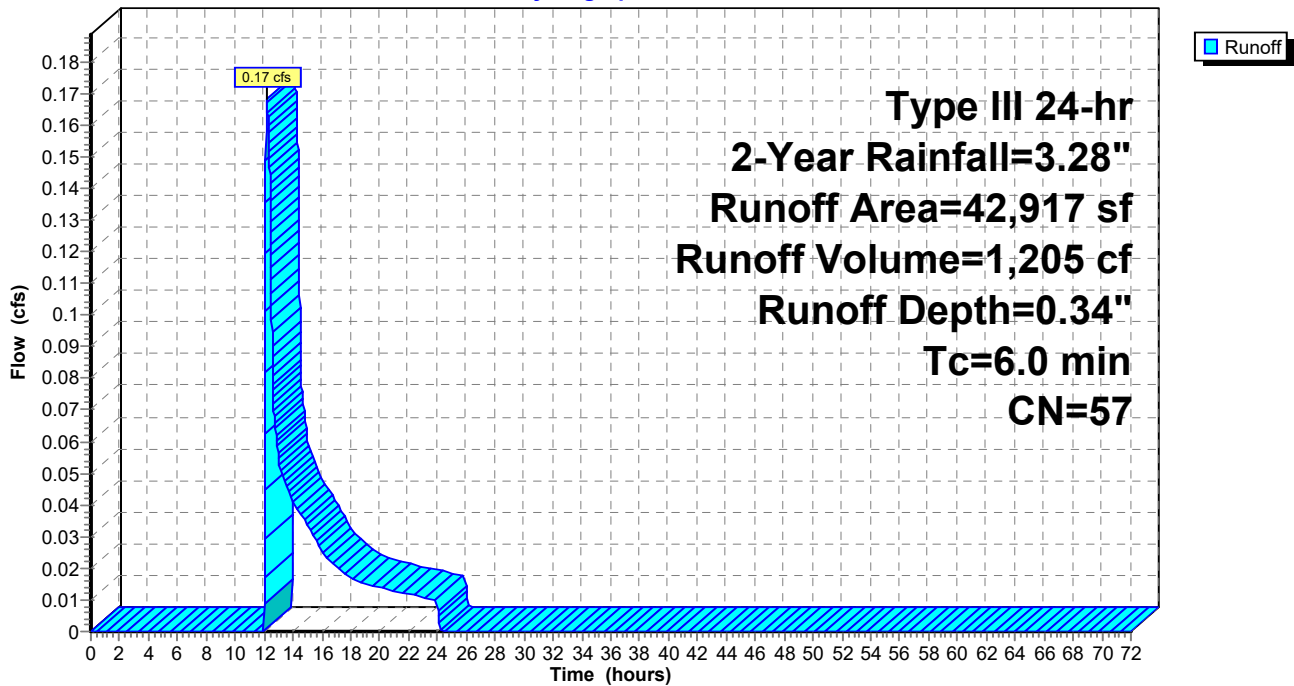

Summary for Pond IS-1: IS-1

[87] Warning: Oscillations may require smaller dt or Finer Routing (severity=275)

Inflow Area = 32,298 sf, 81.57% Impervious, Inflow Depth = 1.99" for 2-Year event
 Inflow = 1.72 cfs @ 12.09 hrs, Volume= 5,345 cf
 Outflow = 0.18 cfs @ 12.92 hrs, Volume= 5,345 cf, Atten= 90%, Lag= 49.9 min
 Discarded = 0.18 cfs @ 12.92 hrs, Volume= 5,345 cf
 Primary = 0.00 cfs @ 0.00 hrs, Volume= 0 cf

Routing by Dyn-Stor-Ind method, Time Span= 0.00-72.00 hrs, dt= 0.01 hrs
 Peak Elev= 10.18' @ 12.92 hrs Surf.Area= 2,619 sf Storage= 1,963 cf

Plug-Flow detention time= (not calculated: outflow precedes inflow)
 Center-of-Mass det. time= 90.4 min (908.3 - 817.8)

Volume	Invert	Avail.Storage	Storage Description
#1A	9.00'	2,381 cf	49.00'W x 53.46'L x 3.50'H Field A 9,168 cf Overall - 3,216 cf Embedded = 5,952 cf x 40.0% Voids
#2A	9.50'	3,216 cf	ADS_StormTech SC-740 +Cap x 70 Inside #1 Effective Size= 44.6"W x 30.0"H => 6.45 sf x 7.12'L = 45.9 cf Overall Size= 51.0"W x 30.0"H x 7.56'L with 0.44' Overlap 70 Chambers in 10 Rows
		5,597 cf	Total Available Storage

Storage Group A created with Chamber Wizard

Device	Routing	Invert	Outlet Devices
#1	Primary	8.10'	12.0" Round Culvert L= 3.0' CPP, square edge headwall, Ke= 0.500 Inlet / Outlet Invert= 8.10' / 8.05' S= 0.0167 '/' Cc= 0.900 n= 0.013 Corrugated PE, smooth interior, Flow Area= 0.79 sf
#2	Device 1	12.00'	4.0' long Sharp-Crested Rectangular Weir 2 End Contraction(s)
#3	Discarded	9.00'	2.410 in/hr Exfiltration over Surface area Conductivity to Groundwater Elevation = 4.00'

Discarded OutFlow Max=0.18 cfs @ 12.92 hrs HW=10.18' (Free Discharge)

↑**3=Exfiltration** (Controls 0.18 cfs)

Primary OutFlow Max=0.00 cfs @ 0.00 hrs HW=9.00' TW=0.00' (Dynamic Tailwater)

↑**1=Culvert** (Passes 0.00 cfs of 1.89 cfs potential flow)

↑**2=Sharp-Crested Rectangular Weir**(Controls 0.00 cfs)

Pond IS-1: IS-1 - Chamber Wizard Field A

Chamber Model = ADS_StormTechSC-740 +Cap (ADS StormTech®SC-740 with cap length)

Effective Size= 44.6"W x 30.0"H => 6.45 sf x 7.12'L = 45.9 cf

Overall Size= 51.0"W x 30.0"H x 7.56'L with 0.44' Overlap

51.0" Wide + 6.0" Spacing = 57.0" C-C Row Spacing

7 Chambers/Row x 7.12' Long +0.81' Cap Length x 2 = 51.46' Row Length +12.0" End Stone x 2 = 53.46' Base Length

10 Rows x 51.0" Wide + 6.0" Spacing x 9 + 12.0" Side Stone x 2 = 49.00' Base Width

6.0" Stone Base + 30.0" Chamber Height + 6.0" Stone Cover = 3.50' Field Height

70 Chambers x 45.9 cf = 3,215.8 cf Chamber Storage

9,167.8 cf Field - 3,215.8 cf Chambers = 5,952.0 cf Stone x 40.0% Voids = 2,380.8 cf Stone Storage

Chamber Storage + Stone Storage = 5,596.6 cf = 0.128 af

Overall Storage Efficiency = 61.0%

Overall System Size = 53.46' x 49.00' x 3.50'

70 Chambers

339.5 cy Field

220.4 cy Stone

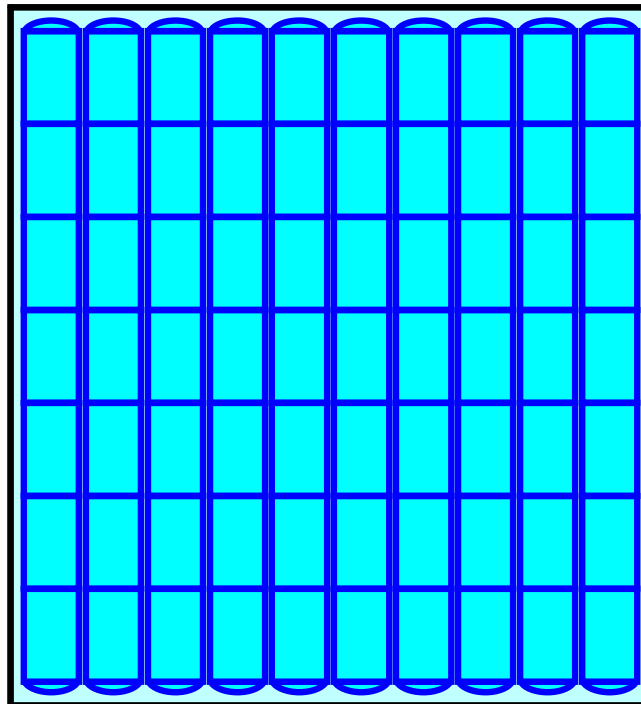

Pond IS-1: IS-1

Hydrograph

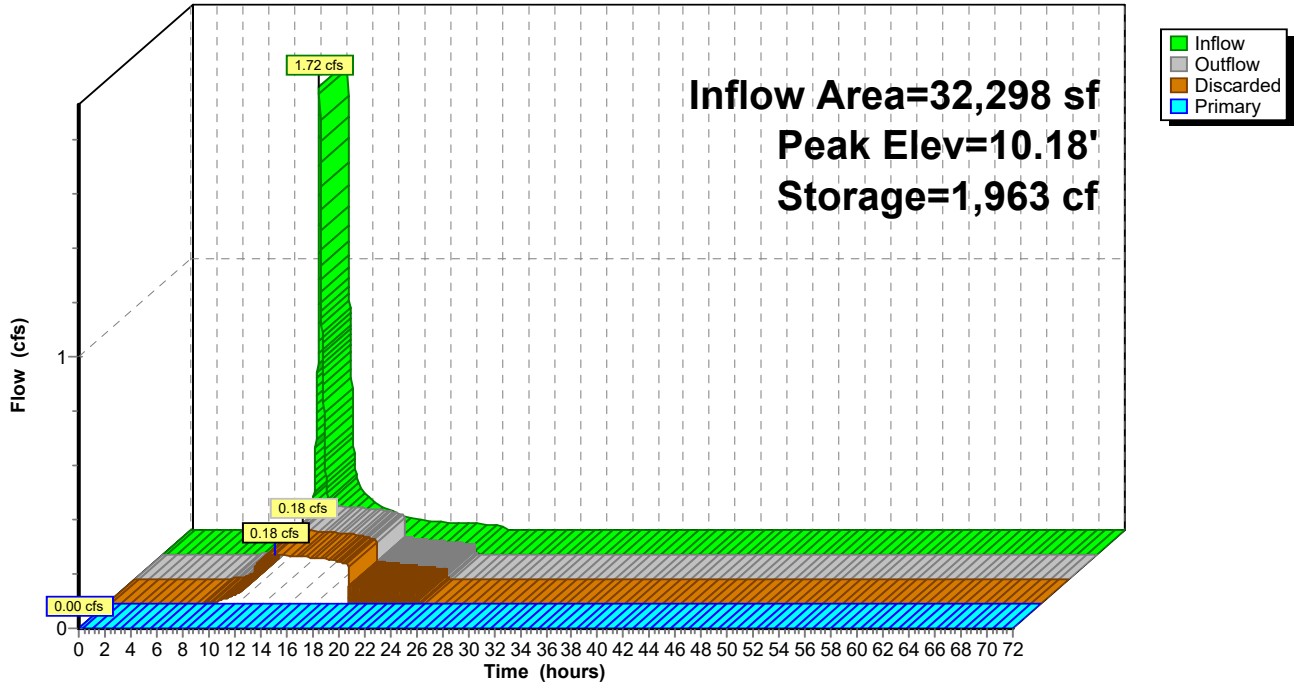

Summary for Link A: POI-A

Inflow Area = 305,609 sf, 22.70% Impervious, Inflow Depth = 0.17" for 2-Year event
Inflow = 0.35 cfs @ 12.42 hrs, Volume= 4,362 cf
Primary = 0.35 cfs @ 12.42 hrs, Volume= 4,362 cf, Atten= 0%, Lag= 0.0 min

Primary outflow = Inflow, Time Span= 0.00-72.00 hrs, dt= 0.01 hrs

Link A: POI-A

Hydrograph

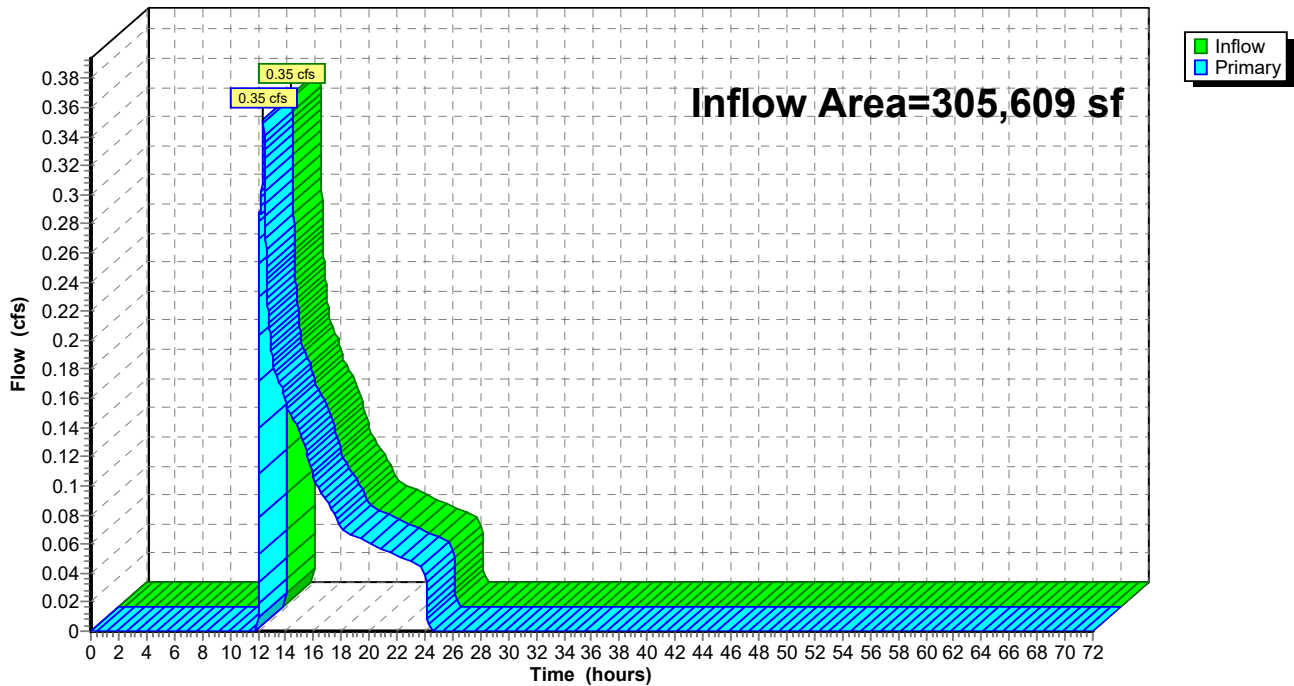

HydroCAD-PR

Prepared by Weston & Sampson

HydroCAD® 10.10-3a s/n 00455 © 2020 HydroCAD Software Solutions LLC

Type III 24-hr 10-Year Rainfall=5.16"

Printed 10/20/2020

Page 18

Time span=0.00-72.00 hrs, dt=0.01 hrs, 7201 points
 Runoff by SCS TR-20 method, UH=SCS, Weighted-CN
 Reach routing by Dyn-Stor-Ind method - Pond routing by Dyn-Stor-Ind method

SubcatchmentA1: SUB-A1 Runoff Area=18,765 sf 27.70% Impervious Runoff Depth=1.06"
 Tc=6.0 min CN=55 Runoff=0.44 cfs 1,659 cf

SubcatchmentA2: SUB-A2 Runoff Area=182,737 sf 10.49% Impervious Runoff Depth=0.76"
 Flow Length=232' Tc=10.0 min CN=50 Runoff=2.12 cfs 11,555 cf

SubcatchmentA3: SUB-A3 Runoff Area=16,685 sf 31.77% Impervious Runoff Depth=1.26"
 Tc=6.0 min CN=58 Runoff=0.50 cfs 1,749 cf

SubcatchmentA4: SUB-A4 Runoff Area=32,298 sf 81.57% Impervious Runoff Depth=3.72"
 Tc=6.0 min CN=87 Runoff=3.17 cfs 10,008 cf

SubcatchmentA5: SUB-A5 Runoff Area=12,207 sf 0.00% Impervious Runoff Depth=0.23"
 Tc=6.0 min CN=39 Runoff=0.02 cfs 238 cf

SubcatchmentA6: SUB-A6 Runoff Area=42,917 sf 31.17% Impervious Runoff Depth=1.19"
 Tc=6.0 min CN=57 Runoff=1.18 cfs 4,259 cf

Pond IS-1: IS-1 Peak Elev=11.51' Storage=4,446 cf Inflow=3.17 cfs 10,008 cf
 Discarded=0.22 cfs 10,009 cf Primary=0.00 cfs 0 cf Outflow=0.22 cfs 10,009 cf

Link A: POI-A Inflow=3.88 cfs 19,459 cf
 Primary=3.88 cfs 19,459 cf

Total Runoff Area = 305,609 sf Runoff Volume = 29,466 cf Average Runoff Depth = 1.16"
77.30% Pervious = 236,226 sf 22.70% Impervious = 69,383 sf

Summary for Subcatchment A1: SUB-A1

Runoff = 0.44 cfs @ 12.11 hrs, Volume= 1,659 cf, Depth= 1.06"

Runoff by SCS TR-20 method, UH=SCS, Weighted-CN, Time Span= 0.00-72.00 hrs, dt= 0.01 hrs
 Type III 24-hr 10-Year Rainfall=5.16"

Area (sf)	CN	Description
5,198	98	Paved parking, HSG A
7,500	39	>75% Grass cover, Good, HSG A
* 6,067	39	Rubber play assume CN of underlying soils
18,765	55	Weighted Average
13,567		72.30% Pervious Area
5,198		27.70% Impervious Area

Tc (min)	Length (feet)	Slope (ft/ft)	Velocity (ft/sec)	Capacity (cfs)	Description
6.0					Direct Entry, Min Tc = 0.1hrs

Subcatchment A1: SUB-A1

Hydrograph

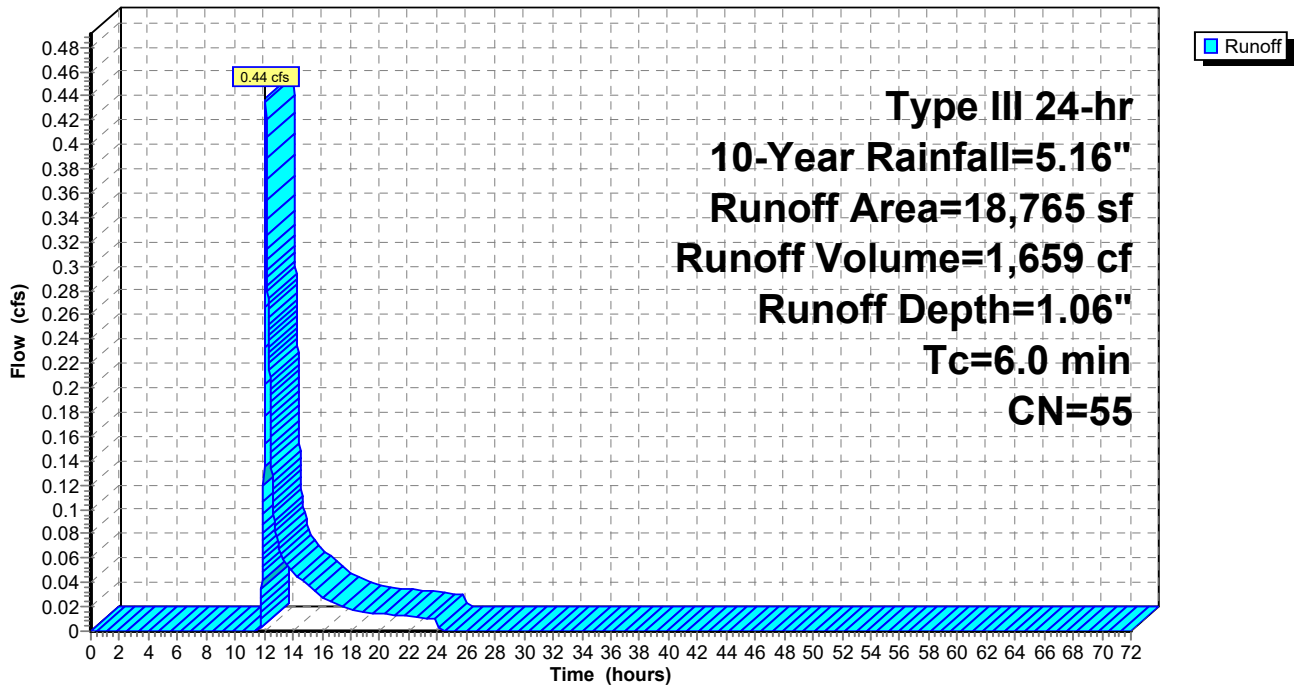

Summary for Subcatchment A2: SUB-A2

Runoff = 2.12 cfs @ 12.19 hrs, Volume= 11,555 cf, Depth= 0.76"

Runoff by SCS TR-20 method, UH=SCS, Weighted-CN, Time Span= 0.00-72.00 hrs, dt= 0.01 hrs
Type III 24-hr 10-Year Rainfall=5.16"

Area (sf)	CN	Description
19,160	98	Paved parking, HSG A
138,300	39	>75% Grass cover, Good, HSG A
25,277	77	Fallow, bare soil, HSG A
182,737	50	Weighted Average
163,577		89.51% Pervious Area
19,160		10.49% Impervious Area

Tc (min)	Length (feet)	Slope (ft/ft)	Velocity (ft/sec)	Capacity (cfs)	Description
9.0	50	0.0060	0.09		Sheet Flow, Sheet Grass: Short n= 0.150 P2= 3.28"
0.2	18	0.0060	1.25		Shallow Concentrated Flow, Shallow 1 Unpaved Kv= 16.1 fps
0.2	85	0.0870	5.99		Shallow Concentrated Flow, Shallow 2 Paved Kv= 20.3 fps
0.6	79	0.0190	2.22		Shallow Concentrated Flow, Shallow 3 Unpaved Kv= 16.1 fps
10.0	232	Total			

Subcatchment A2: SUB-A2

Hydrograph

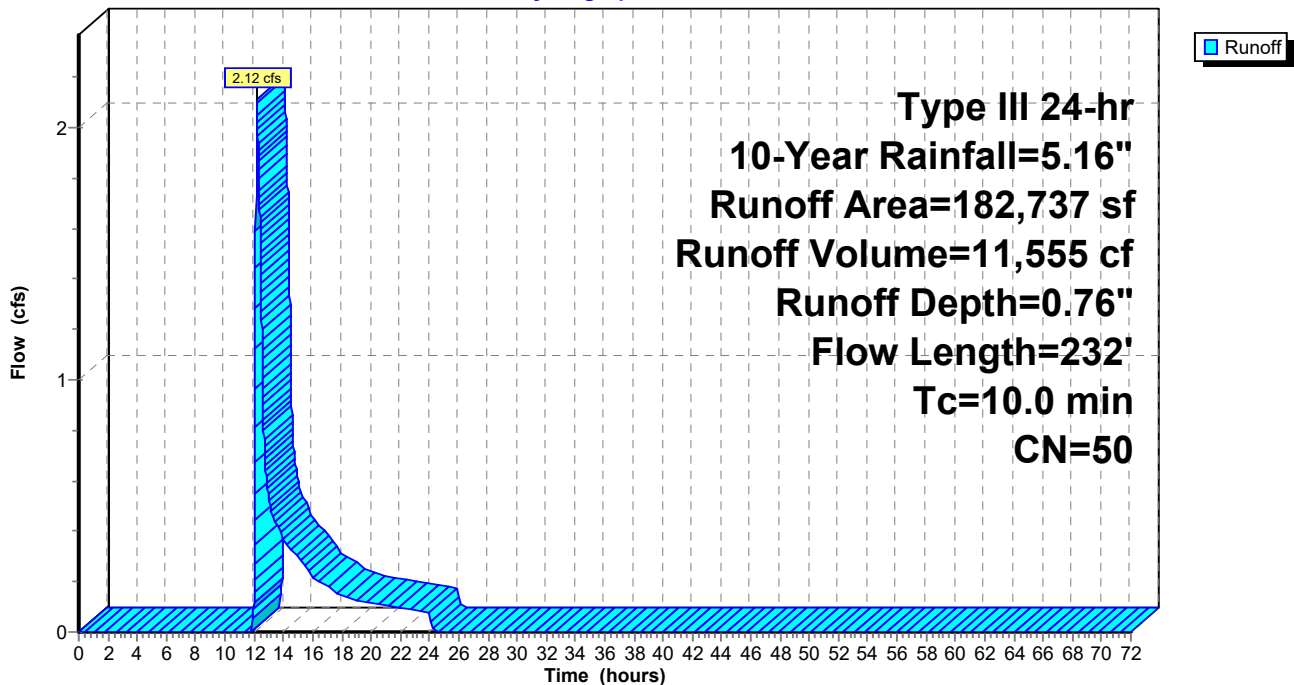

Summary for Subcatchment A3: SUB-A3

Runoff = 0.50 cfs @ 12.10 hrs, Volume= 1,749 cf, Depth= 1.26"

Runoff by SCS TR-20 method, UH=SCS, Weighted-CN, Time Span= 0.00-72.00 hrs, dt= 0.01 hrs
Type III 24-hr 10-Year Rainfall=5.16"

Area (sf)	CN	Description
5,301	98	Paved parking, HSG A
11,384	39	>75% Grass cover, Good, HSG A
16,685	58	Weighted Average
11,384		68.23% Pervious Area
5,301		31.77% Impervious Area

Tc (min)	Length (feet)	Slope (ft/ft)	Velocity (ft/sec)	Capacity (cfs)	Description
6.0					Direct Entry, Min Tc = 0.1hrs

Subcatchment A3: SUB-A3

Hydrograph

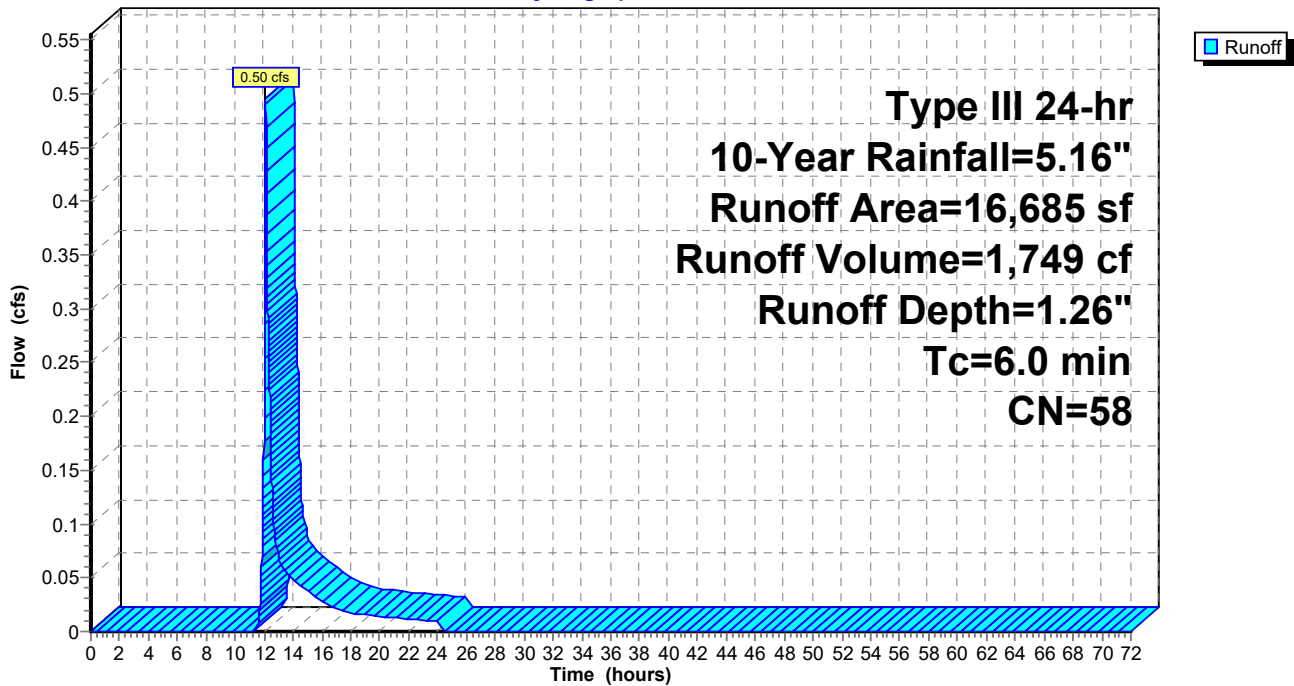

Summary for Subcatchment A4: SUB-A4

Runoff = 3.17 cfs @ 12.09 hrs, Volume= 10,008 cf, Depth= 3.72"

Runoff by SCS TR-20 method, UH=SCS, Weighted-CN, Time Span= 0.00-72.00 hrs, dt= 0.01 hrs
 Type III 24-hr 10-Year Rainfall=5.16"

Area (sf)	CN	Description
26,345	98	Paved parking, HSG A
5,953	39	>75% Grass cover, Good, HSG A
32,298	87	Weighted Average
5,953		18.43% Pervious Area
26,345		81.57% Impervious Area

Tc (min)	Length (feet)	Slope (ft/ft)	Velocity (ft/sec)	Capacity (cfs)	Description
6.0					Direct Entry, Min Tc = 0.1hrs

Subcatchment A4: SUB-A4

Hydrograph

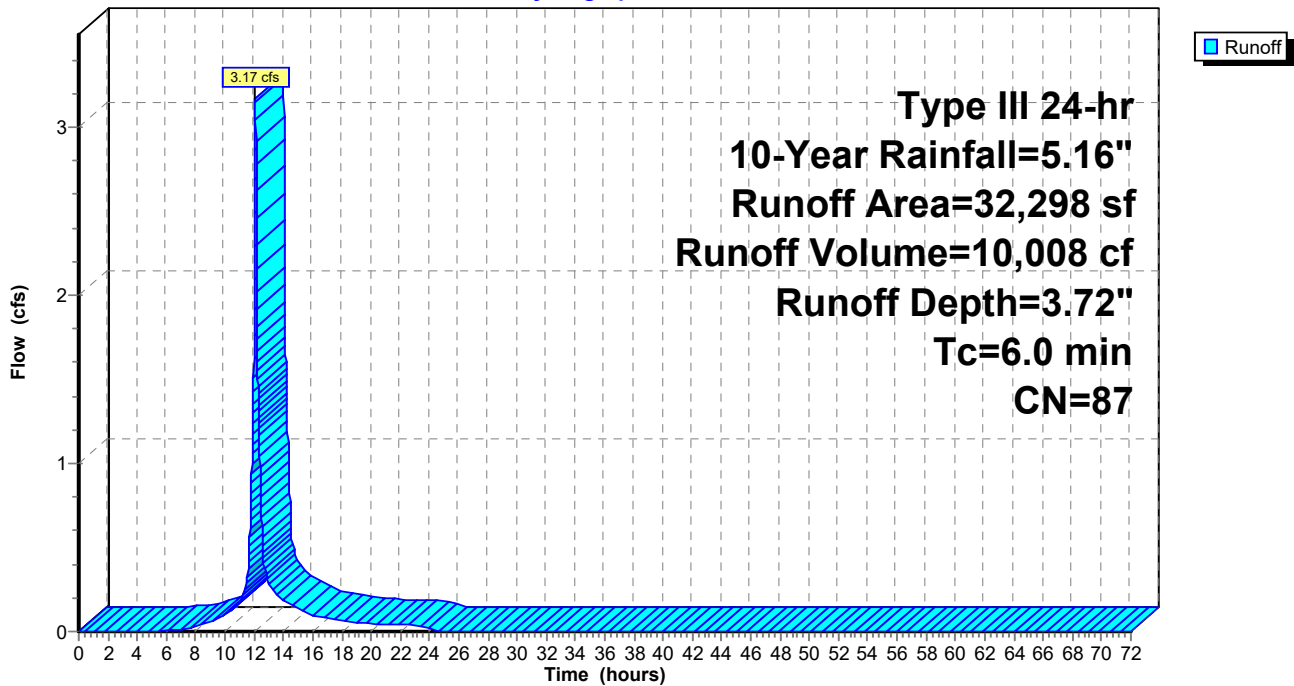

Summary for Subcatchment A5: SUB-A5

Runoff = 0.02 cfs @ 12.45 hrs, Volume= 238 cf, Depth= 0.23"

Runoff by SCS TR-20 method, UH=SCS, Weighted-CN, Time Span= 0.00-72.00 hrs, dt= 0.01 hrs
 Type III 24-hr 10-Year Rainfall=5.16"

Area (sf)	CN	Description
12,207	39	>75% Grass cover, Good, HSG A
12,207		100.00% Pervious Area

Tc (min)	Length (feet)	Slope (ft/ft)	Velocity (ft/sec)	Capacity (cfs)	Description
6.0					Direct Entry, Min Tc = 0.1hrs

Subcatchment A5: SUB-A5

Hydrograph

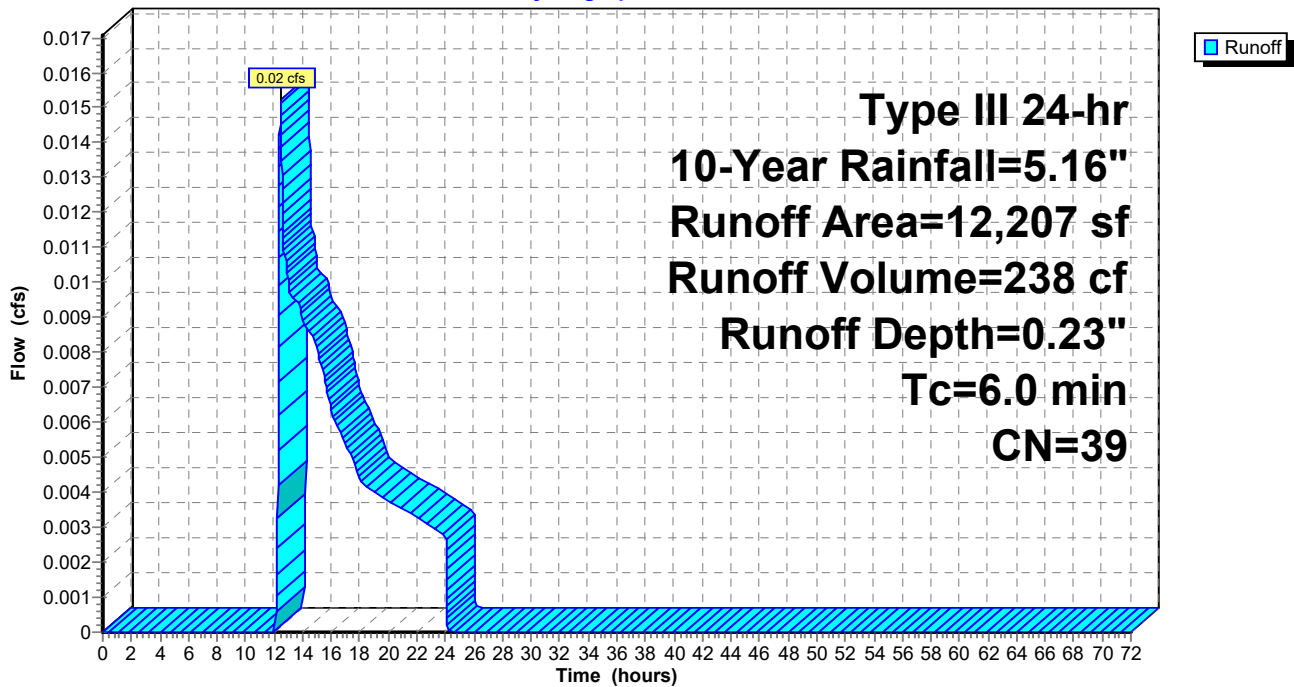

Summary for Subcatchment A6: SUB-A6

Runoff = 1.18 cfs @ 12.10 hrs, Volume= 4,259 cf, Depth= 1.19"

Runoff by SCS TR-20 method, UH=SCS, Weighted-CN, Time Span= 0.00-72.00 hrs, dt= 0.01 hrs
 Type III 24-hr 10-Year Rainfall=5.16"

Area (sf)	CN	Description
13,379	98	Paved parking, HSG A
29,538	39	>75% Grass cover, Good, HSG A
42,917	57	Weighted Average
29,538		68.83% Pervious Area
13,379		31.17% Impervious Area

Tc (min)	Length (feet)	Slope (ft/ft)	Velocity (ft/sec)	Capacity (cfs)	Description
6.0					Direct Entry, Min Tc = 0.1hrs

Subcatchment A6: SUB-A6

Hydrograph

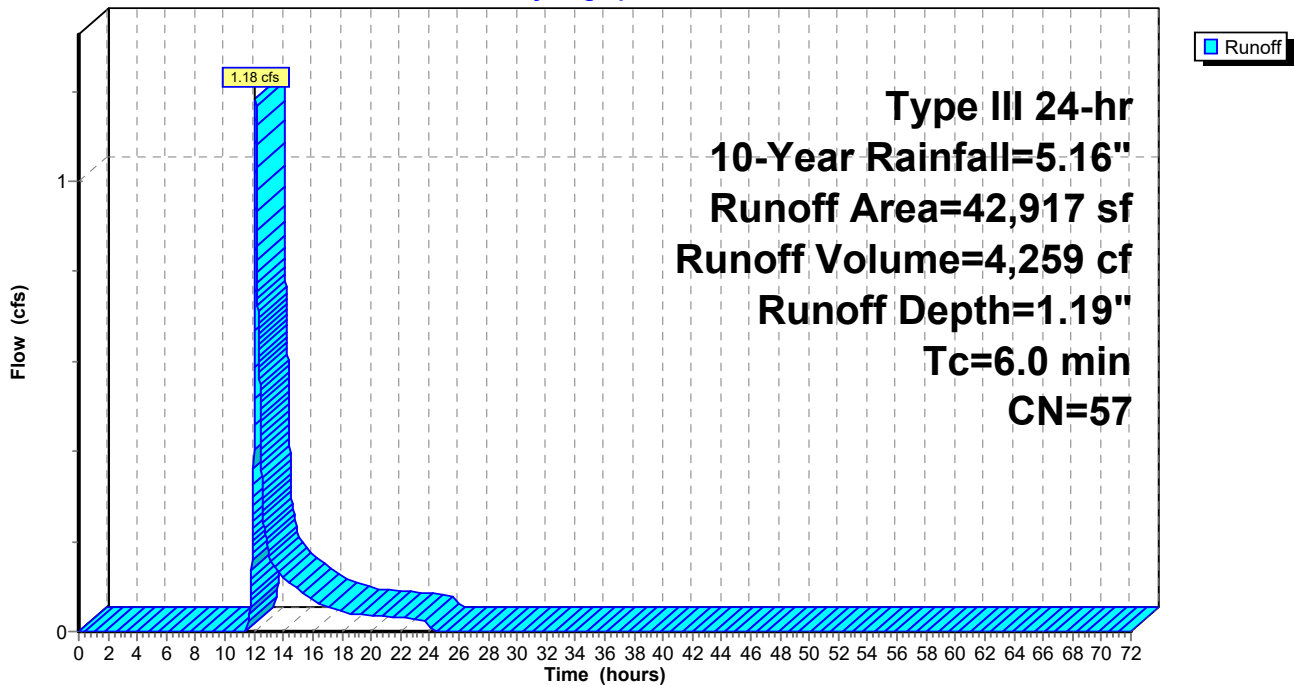

Summary for Pond IS-1: IS-1

Inflow Area = 32,298 sf, 81.57% Impervious, Inflow Depth = 3.72" for 10-Year event
 Inflow = 3.17 cfs @ 12.09 hrs, Volume= 10,008 cf
 Outflow = 0.22 cfs @ 13.55 hrs, Volume= 10,009 cf, Atten= 93%, Lag= 88.0 min
 Discarded = 0.22 cfs @ 13.55 hrs, Volume= 10,009 cf
 Primary = 0.00 cfs @ 0.00 hrs, Volume= 0 cf

Routing by Dyn-Stor-Ind method, Time Span= 0.00-72.00 hrs, dt= 0.01 hrs
 Peak Elev= 11.51' @ 13.55 hrs Surf.Area= 2,619 sf Storage= 4,446 cf

Plug-Flow detention time= (not calculated: outflow precedes inflow)
 Center-of-Mass det. time= 196.9 min (997.0 - 800.1)

Volume	Invert	Avail.Storage	Storage Description
#1A	9.00'	2,381 cf	49.00'W x 53.46'L x 3.50'H Field A 9,168 cf Overall - 3,216 cf Embedded = 5,952 cf x 40.0% Voids
#2A	9.50'	3,216 cf	ADS_StormTech SC-740 +Cap x 70 Inside #1 Effective Size= 44.6"W x 30.0"H => 6.45 sf x 7.12'L = 45.9 cf Overall Size= 51.0"W x 30.0"H x 7.56'L with 0.44' Overlap 70 Chambers in 10 Rows
		5,597 cf	Total Available Storage

Storage Group A created with Chamber Wizard

Device	Routing	Invert	Outlet Devices
#1	Primary	8.10'	12.0" Round Culvert L= 3.0' CPP, square edge headwall, Ke= 0.500 Inlet / Outlet Invert= 8.10' / 8.05' S= 0.0167 '/' Cc= 0.900 n= 0.013 Corrugated PE, smooth interior, Flow Area= 0.79 sf
#2	Device 1	12.00'	4.0' long Sharp-Crested Rectangular Weir 2 End Contraction(s)
#3	Discarded	9.00'	2.410 in/hr Exfiltration over Surface area Conductivity to Groundwater Elevation = 4.00'

Discarded OutFlow Max=0.22 cfs @ 13.55 hrs HW=11.51' (Free Discharge)

↑**3=Exfiltration** (Controls 0.22 cfs)

Primary OutFlow Max=0.00 cfs @ 0.00 hrs HW=9.00' TW=0.00' (Dynamic Tailwater)

↑**1=Culvert** (Passes 0.00 cfs of 1.89 cfs potential flow)

↑**2=Sharp-Crested Rectangular Weir**(Controls 0.00 cfs)

Pond IS-1: IS-1 - Chamber Wizard Field A

Chamber Model = ADS_StormTechSC-740 +Cap (ADS StormTech®SC-740 with cap length)

Effective Size= 44.6"W x 30.0"H => 6.45 sf x 7.12'L = 45.9 cf

Overall Size= 51.0"W x 30.0"H x 7.56'L with 0.44' Overlap

51.0" Wide + 6.0" Spacing = 57.0" C-C Row Spacing

7 Chambers/Row x 7.12' Long +0.81' Cap Length x 2 = 51.46' Row Length +12.0" End Stone x 2 = 53.46' Base Length

10 Rows x 51.0" Wide + 6.0" Spacing x 9 + 12.0" Side Stone x 2 = 49.00' Base Width

6.0" Stone Base + 30.0" Chamber Height + 6.0" Stone Cover = 3.50' Field Height

70 Chambers x 45.9 cf = 3,215.8 cf Chamber Storage

9,167.8 cf Field - 3,215.8 cf Chambers = 5,952.0 cf Stone x 40.0% Voids = 2,380.8 cf Stone Storage

Chamber Storage + Stone Storage = 5,596.6 cf = 0.128 af

Overall Storage Efficiency = 61.0%

Overall System Size = 53.46' x 49.00' x 3.50'

70 Chambers

339.5 cy Field

220.4 cy Stone

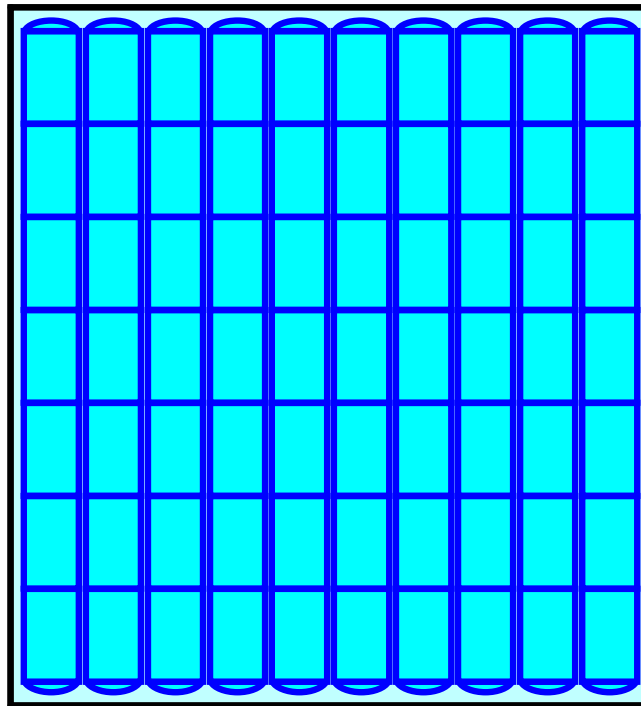

Pond IS-1: IS-1

Hydrograph

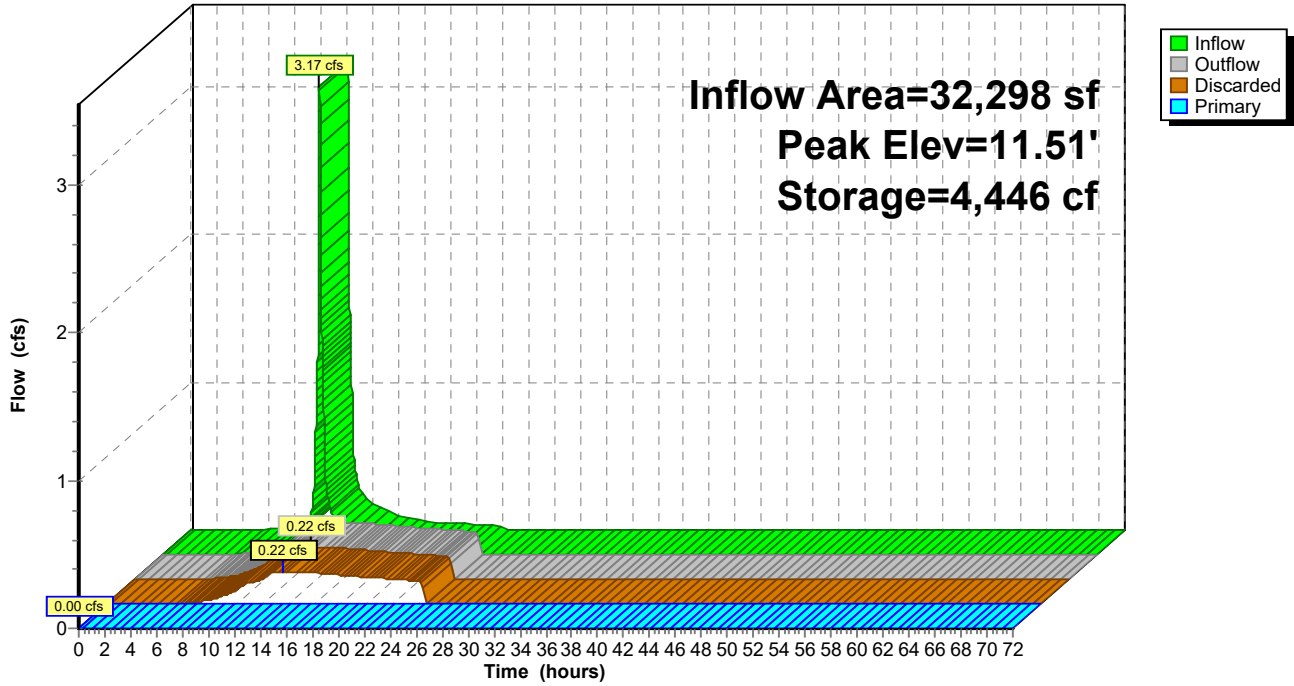

Summary for Link A: POI-A

Inflow Area = 305,609 sf, 22.70% Impervious, Inflow Depth = 0.76" for 10-Year event
Inflow = 3.88 cfs @ 12.14 hrs, Volume= 19,459 cf
Primary = 3.88 cfs @ 12.14 hrs, Volume= 19,459 cf, Atten= 0%, Lag= 0.0 min

Primary outflow = Inflow, Time Span= 0.00-72.00 hrs, dt= 0.01 hrs

Link A: POI-A

Hydrograph

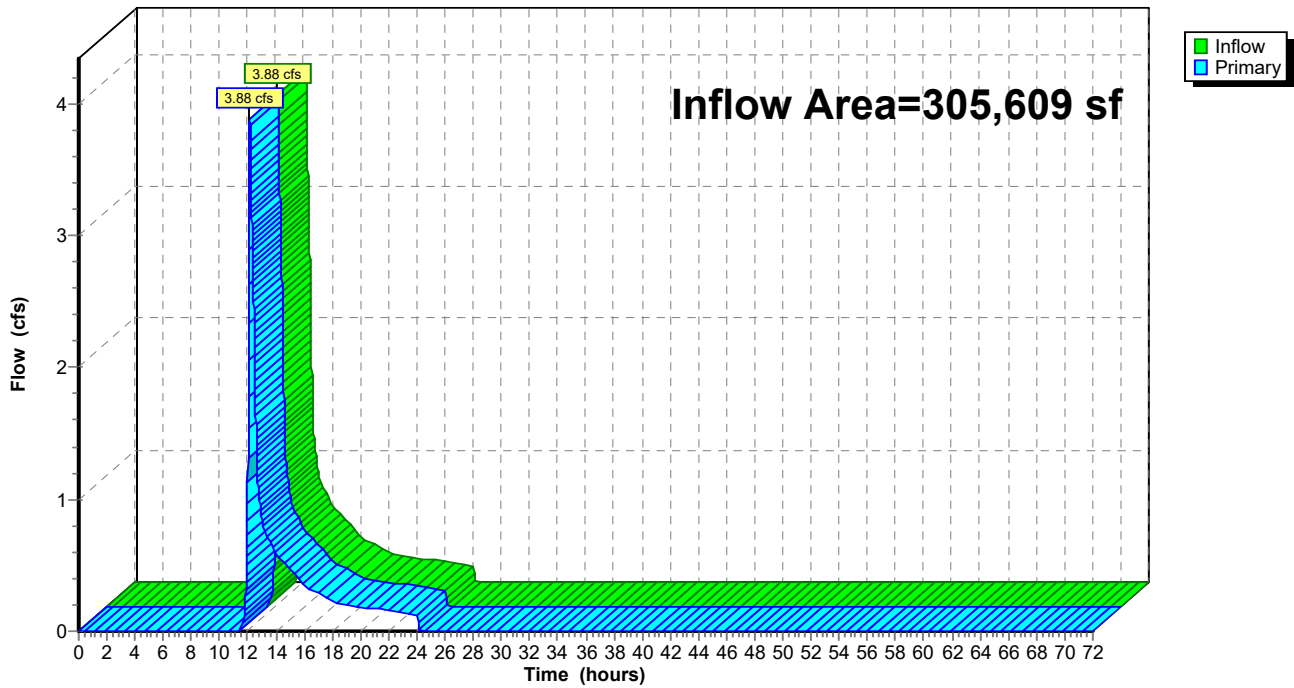

HydroCAD-PR

Prepared by Weston & Sampson

HydroCAD® 10.10-3a s/n 00455 © 2020 HydroCAD Software Solutions LLC

Type III 24-hr 25-Year Rainfall=6.33"

Printed 10/20/2020

Page 29

Time span=0.00-72.00 hrs, dt=0.01 hrs, 7201 points
 Runoff by SCS TR-20 method, UH=SCS, Weighted-CN
 Reach routing by Dyn-Stor-Ind method - Pond routing by Dyn-Stor-Ind method

SubcatchmentA1: SUB-A1 Runoff Area=18,765 sf 27.70% Impervious Runoff Depth=1.71"
 Tc=6.0 min CN=55 Runoff=0.78 cfs 2,676 cf

SubcatchmentA2: SUB-A2 Runoff Area=182,737 sf 10.49% Impervious Runoff Depth=1.31"
 Flow Length=232' Tc=10.0 min CN=50 Runoff=4.56 cfs 19,924 cf

SubcatchmentA3: SUB-A3 Runoff Area=16,685 sf 31.77% Impervious Runoff Depth=1.97"
 Tc=6.0 min CN=58 Runoff=0.83 cfs 2,733 cf

SubcatchmentA4: SUB-A4 Runoff Area=32,298 sf 81.57% Impervious Runoff Depth=4.83"
 Tc=6.0 min CN=87 Runoff=4.07 cfs 13,010 cf

SubcatchmentA5: SUB-A5 Runoff Area=12,207 sf 0.00% Impervious Runoff Depth=0.54"
 Tc=6.0 min CN=39 Runoff=0.07 cfs 553 cf

SubcatchmentA6: SUB-A6 Runoff Area=42,917 sf 31.17% Impervious Runoff Depth=1.88"
 Tc=6.0 min CN=57 Runoff=2.02 cfs 6,723 cf

Pond IS-1: IS-1 Peak Elev=12.16' Storage=5,244 cf Inflow=4.07 cfs 13,010 cf
 Discarded=0.24 cfs 11,848 cf Primary=0.86 cfs 1,163 cf Outflow=1.10 cfs 13,011 cf

Link A: POI-A Inflow=7.75 cfs 33,772 cf
 Primary=7.75 cfs 33,772 cf

Total Runoff Area = 305,609 sf Runoff Volume = 45,619 cf Average Runoff Depth = 1.79"
77.30% Pervious = 236,226 sf 22.70% Impervious = 69,383 sf

Summary for Subcatchment A1: SUB-A1

Runoff = 0.78 cfs @ 12.10 hrs, Volume= 2,676 cf, Depth= 1.71"

Runoff by SCS TR-20 method, UH=SCS, Weighted-CN, Time Span= 0.00-72.00 hrs, dt= 0.01 hrs
 Type III 24-hr 25-Year Rainfall=6.33"

Area (sf)	CN	Description
5,198	98	Paved parking, HSG A
7,500	39	>75% Grass cover, Good, HSG A
* 6,067	39	Rubber play assume CN of underlying soils
18,765	55	Weighted Average
13,567		72.30% Pervious Area
5,198		27.70% Impervious Area

Tc (min)	Length (feet)	Slope (ft/ft)	Velocity (ft/sec)	Capacity (cfs)	Description
6.0					Direct Entry, Min Tc = 0.1hrs

Subcatchment A1: SUB-A1

Hydrograph

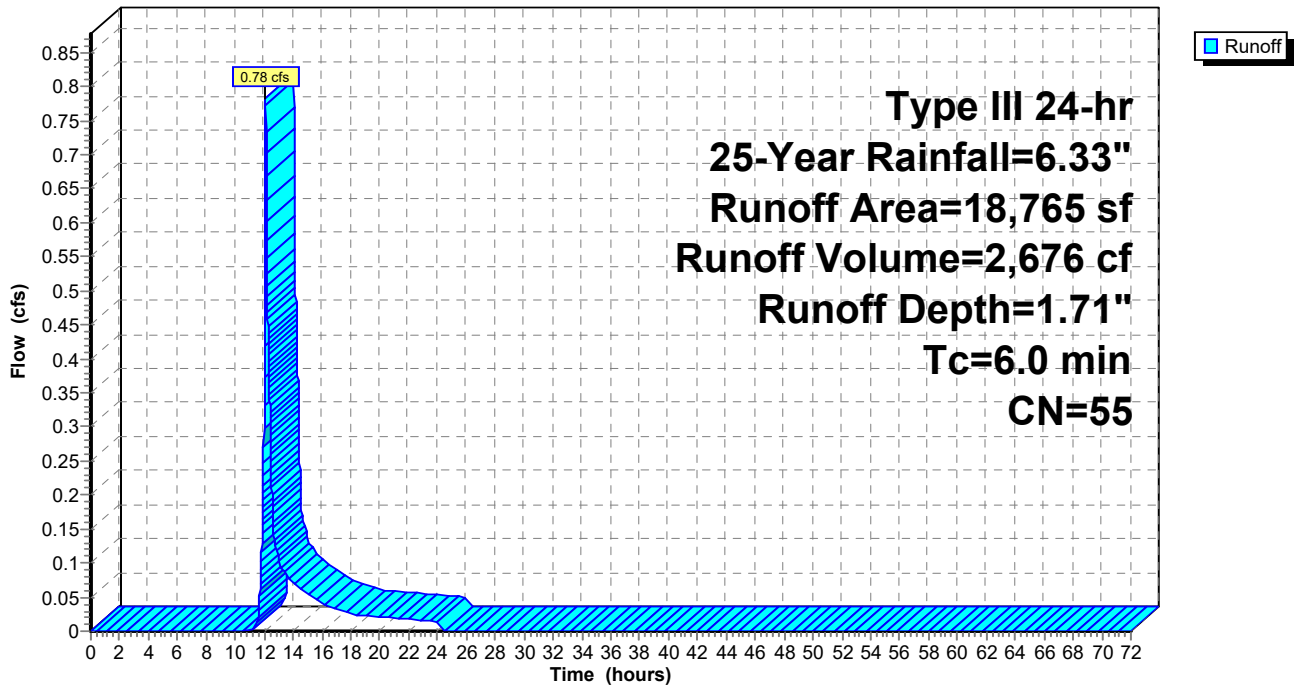

Summary for Subcatchment A2: SUB-A2

Runoff = 4.56 cfs @ 12.16 hrs, Volume= 19,924 cf, Depth= 1.31"

Runoff by SCS TR-20 method, UH=SCS, Weighted-CN, Time Span= 0.00-72.00 hrs, dt= 0.01 hrs
Type III 24-hr 25-Year Rainfall=6.33"

Area (sf)	CN	Description
19,160	98	Paved parking, HSG A
138,300	39	>75% Grass cover, Good, HSG A
25,277	77	Fallow, bare soil, HSG A
182,737	50	Weighted Average
163,577		89.51% Pervious Area
19,160		10.49% Impervious Area

Tc (min)	Length (feet)	Slope (ft/ft)	Velocity (ft/sec)	Capacity (cfs)	Description
9.0	50	0.0060	0.09		Sheet Flow, Sheet Grass: Short n= 0.150 P2= 3.28"
0.2	18	0.0060	1.25		Shallow Concentrated Flow, Shallow 1 Unpaved Kv= 16.1 fps
0.2	85	0.0870	5.99		Shallow Concentrated Flow, Shallow 2 Paved Kv= 20.3 fps
0.6	79	0.0190	2.22		Shallow Concentrated Flow, Shallow 3 Unpaved Kv= 16.1 fps
10.0	232	Total			

Subcatchment A2: SUB-A2

Hydrograph

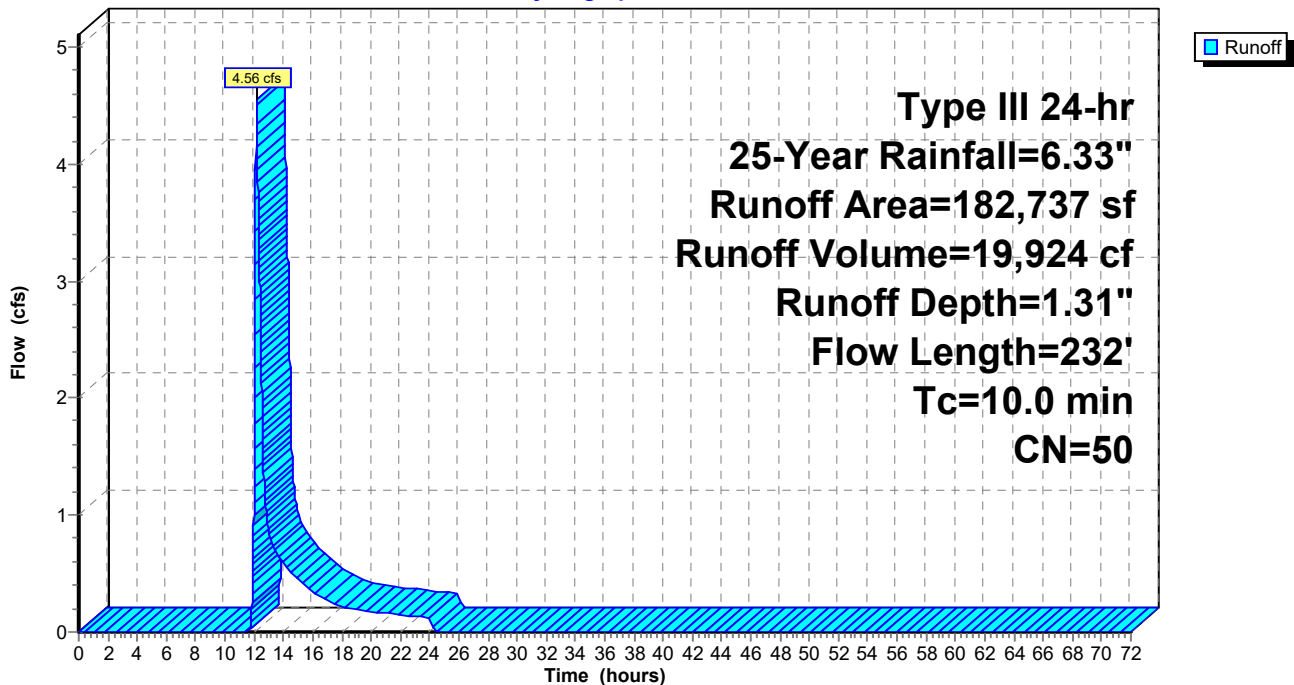

Summary for Subcatchment A3: SUB-A3

Runoff = 0.83 cfs @ 12.10 hrs, Volume= 2,733 cf, Depth= 1.97"

Runoff by SCS TR-20 method, UH=SCS, Weighted-CN, Time Span= 0.00-72.00 hrs, dt= 0.01 hrs
 Type III 24-hr 25-Year Rainfall=6.33"

Area (sf)	CN	Description
5,301	98	Paved parking, HSG A
11,384	39	>75% Grass cover, Good, HSG A
16,685	58	Weighted Average
11,384		68.23% Pervious Area
5,301		31.77% Impervious Area

Tc (min)	Length (feet)	Slope (ft/ft)	Velocity (ft/sec)	Capacity (cfs)	Description
6.0					Direct Entry, Min Tc = 0.1hrs

Subcatchment A3: SUB-A3

Hydrograph

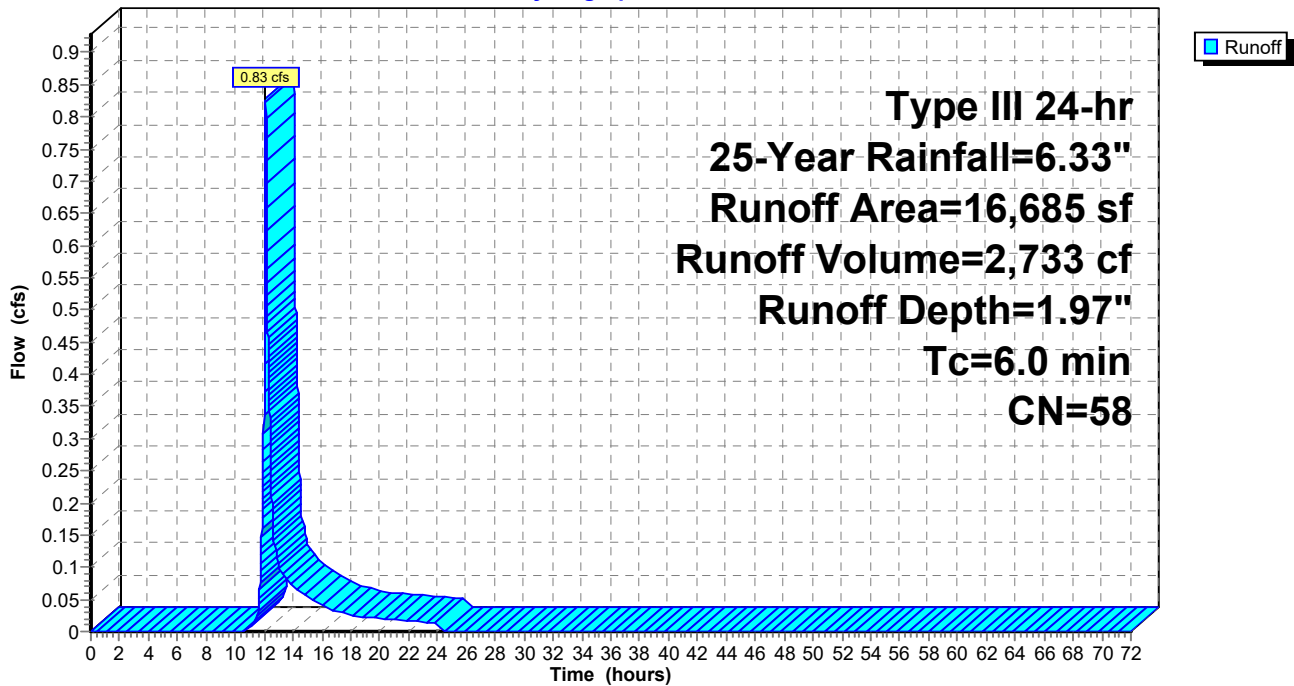

Summary for Subcatchment A4: SUB-A4

Runoff = 4.07 cfs @ 12.09 hrs, Volume= 13,010 cf, Depth= 4.83"

Runoff by SCS TR-20 method, UH=SCS, Weighted-CN, Time Span= 0.00-72.00 hrs, dt= 0.01 hrs
 Type III 24-hr 25-Year Rainfall=6.33"

Area (sf)	CN	Description
26,345	98	Paved parking, HSG A
5,953	39	>75% Grass cover, Good, HSG A
32,298	87	Weighted Average
5,953		18.43% Pervious Area
26,345		81.57% Impervious Area

Tc (min)	Length (feet)	Slope (ft/ft)	Velocity (ft/sec)	Capacity (cfs)	Description
6.0					Direct Entry, Min Tc = 0.1hrs

Subcatchment A4: SUB-A4

Hydrograph

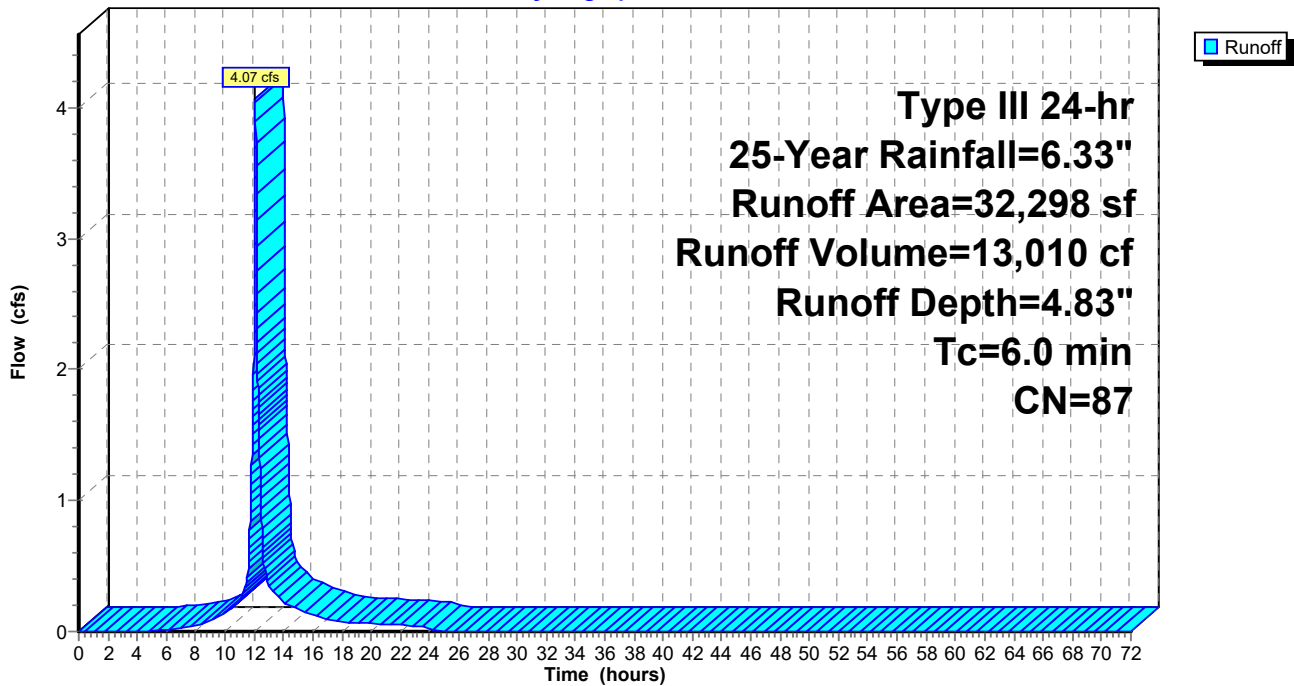

Summary for Subcatchment A5: SUB-A5

Runoff = 0.07 cfs @ 12.31 hrs, Volume= 553 cf, Depth= 0.54"

Runoff by SCS TR-20 method, UH=SCS, Weighted-CN, Time Span= 0.00-72.00 hrs, dt= 0.01 hrs
 Type III 24-hr 25-Year Rainfall=6.33"

Area (sf)	CN	Description
12,207	39	>75% Grass cover, Good, HSG A
12,207		100.00% Pervious Area

Tc (min)	Length (feet)	Slope (ft/ft)	Velocity (ft/sec)	Capacity (cfs)	Description
6.0					Direct Entry, Min Tc = 0.1hrs

Subcatchment A5: SUB-A5

Hydrograph

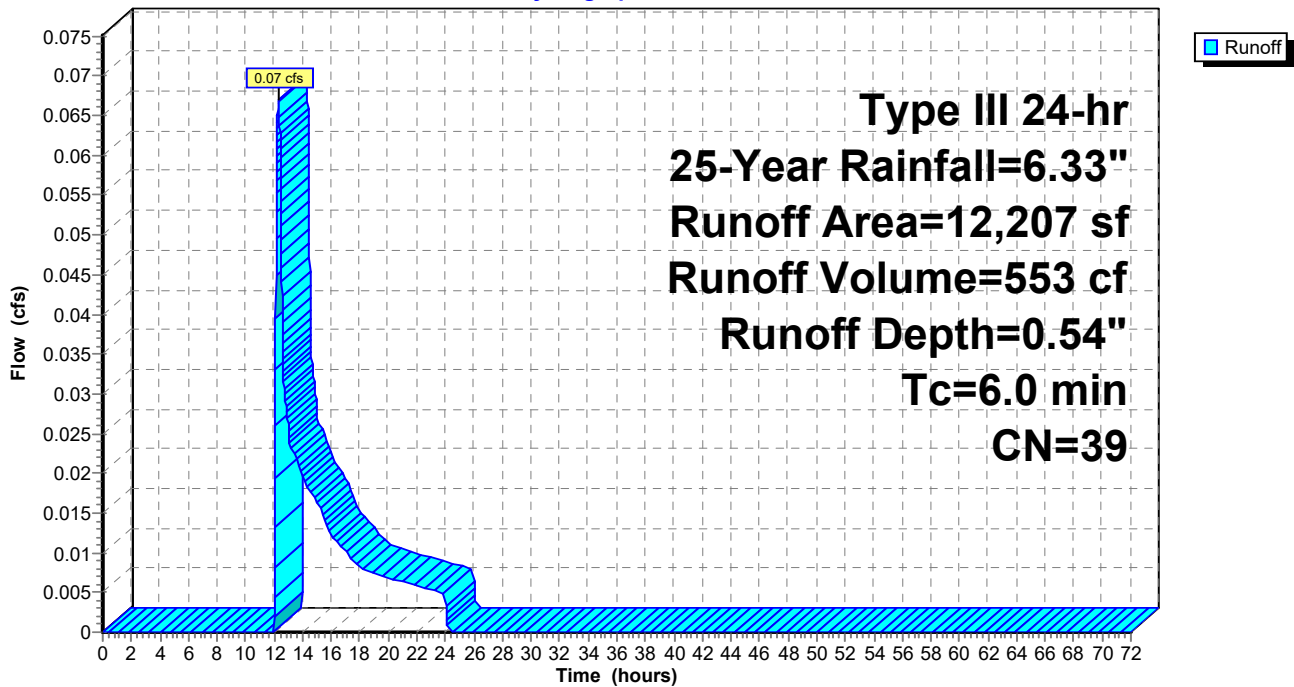

Summary for Subcatchment A6: SUB-A6

Runoff = 2.02 cfs @ 12.10 hrs, Volume= 6,723 cf, Depth= 1.88"

Runoff by SCS TR-20 method, UH=SCS, Weighted-CN, Time Span= 0.00-72.00 hrs, dt= 0.01 hrs
Type III 24-hr 25-Year Rainfall=6.33"

Area (sf)	CN	Description
13,379	98	Paved parking, HSG A
29,538	39	>75% Grass cover, Good, HSG A
42,917	57	Weighted Average
29,538		68.83% Pervious Area
13,379		31.17% Impervious Area

Tc (min)	Length (feet)	Slope (ft/ft)	Velocity (ft/sec)	Capacity (cfs)	Description
6.0					Direct Entry, Min Tc = 0.1hrs

Subcatchment A6: SUB-A6

Hydrograph

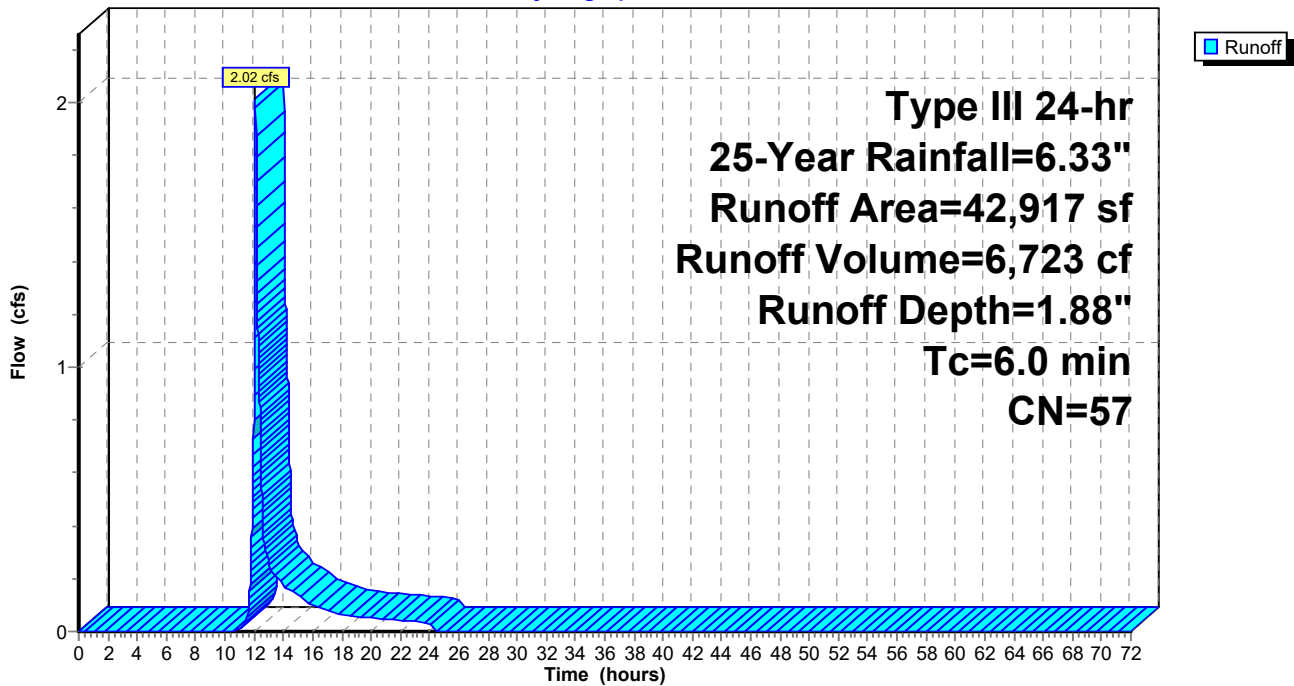

Summary for Pond IS-1: IS-1

Inflow Area = 32,298 sf, 81.57% Impervious, Inflow Depth = 4.83" for 25-Year event
 Inflow = 4.07 cfs @ 12.09 hrs, Volume= 13,010 cf
 Outflow = 1.10 cfs @ 12.44 hrs, Volume= 13,011 cf, Atten= 73%, Lag= 21.5 min
 Discarded = 0.24 cfs @ 12.44 hrs, Volume= 11,848 cf
 Primary = 0.86 cfs @ 12.44 hrs, Volume= 1,163 cf

Routing by Dyn-Stor-Ind method, Time Span= 0.00-72.00 hrs, dt= 0.01 hrs
 Peak Elev= 12.16' @ 12.44 hrs Surf.Area= 2,619 sf Storage= 5,244 cf

Plug-Flow detention time= (not calculated: outflow precedes inflow)
 Center-of-Mass det. time= 202.3 min (995.1 - 792.8)

Volume	Invert	Avail.Storage	Storage Description
#1A	9.00'	2,381 cf	49.00'W x 53.46'L x 3.50'H Field A 9,168 cf Overall - 3,216 cf Embedded = 5,952 cf x 40.0% Voids
#2A	9.50'	3,216 cf	ADS_StormTech SC-740 +Cap x 70 Inside #1 Effective Size= 44.6"W x 30.0"H => 6.45 sf x 7.12'L = 45.9 cf Overall Size= 51.0"W x 30.0"H x 7.56'L with 0.44' Overlap 70 Chambers in 10 Rows
		5,597 cf	Total Available Storage

Storage Group A created with Chamber Wizard

Device	Routing	Invert	Outlet Devices
#1	Primary	8.10'	12.0" Round Culvert L= 3.0' CPP, square edge headwall, Ke= 0.500 Inlet / Outlet Invert= 8.10' / 8.05' S= 0.0167 '/' Cc= 0.900 n= 0.013 Corrugated PE, smooth interior, Flow Area= 0.79 sf
#2	Device 1	12.00'	4.0' long Sharp-Crested Rectangular Weir 2 End Contraction(s)
#3	Discarded	9.00'	2.410 in/hr Exfiltration over Surface area Conductivity to Groundwater Elevation = 4.00'

Discarded OutFlow Max=0.24 cfs @ 12.44 hrs HW=12.16' (Free Discharge)
 ↑ **3=Exfiltration** (Controls 0.24 cfs)

Primary OutFlow Max=0.86 cfs @ 12.44 hrs HW=12.16' TW=0.00' (Dynamic Tailwater)
 ↑ **1=Culvert** (Passes 0.86 cfs of 7.14 cfs potential flow)
 ↑ **2=Sharp-Crested Rectangular Weir**(Weir Controls 0.86 cfs @ 1.32 fps)

Pond IS-1: IS-1 - Chamber Wizard Field A

Chamber Model = ADS_StormTechSC-740 +Cap (ADS StormTech®SC-740 with cap length)

Effective Size= 44.6"W x 30.0"H => 6.45 sf x 7.12'L = 45.9 cf

Overall Size= 51.0"W x 30.0"H x 7.56'L with 0.44' Overlap

51.0" Wide + 6.0" Spacing = 57.0" C-C Row Spacing

7 Chambers/Row x 7.12' Long +0.81' Cap Length x 2 = 51.46' Row Length +12.0" End Stone x 2 = 53.46' Base Length

10 Rows x 51.0" Wide + 6.0" Spacing x 9 + 12.0" Side Stone x 2 = 49.00' Base Width

6.0" Stone Base + 30.0" Chamber Height + 6.0" Stone Cover = 3.50' Field Height

70 Chambers x 45.9 cf = 3,215.8 cf Chamber Storage

9,167.8 cf Field - 3,215.8 cf Chambers = 5,952.0 cf Stone x 40.0% Voids = 2,380.8 cf Stone Storage

Chamber Storage + Stone Storage = 5,596.6 cf = 0.128 af

Overall Storage Efficiency = 61.0%

Overall System Size = 53.46' x 49.00' x 3.50'

70 Chambers

339.5 cy Field

220.4 cy Stone

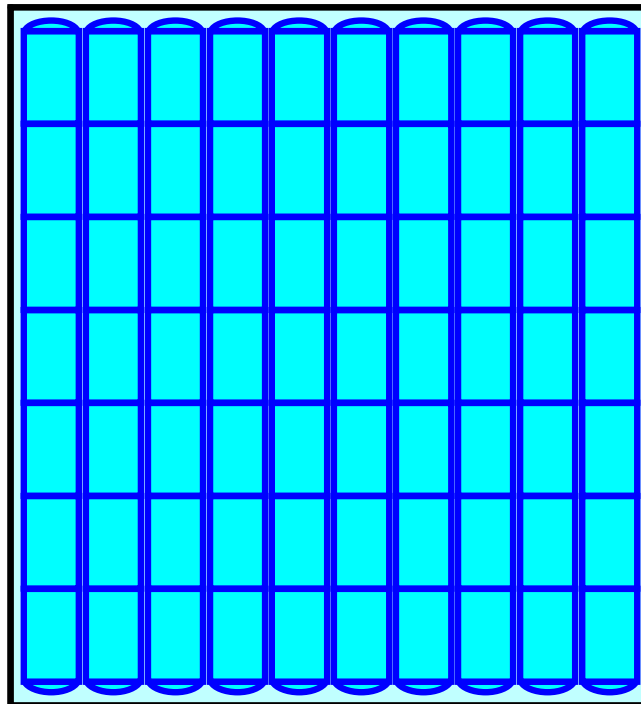

Pond IS-1: IS-1

Hydrograph

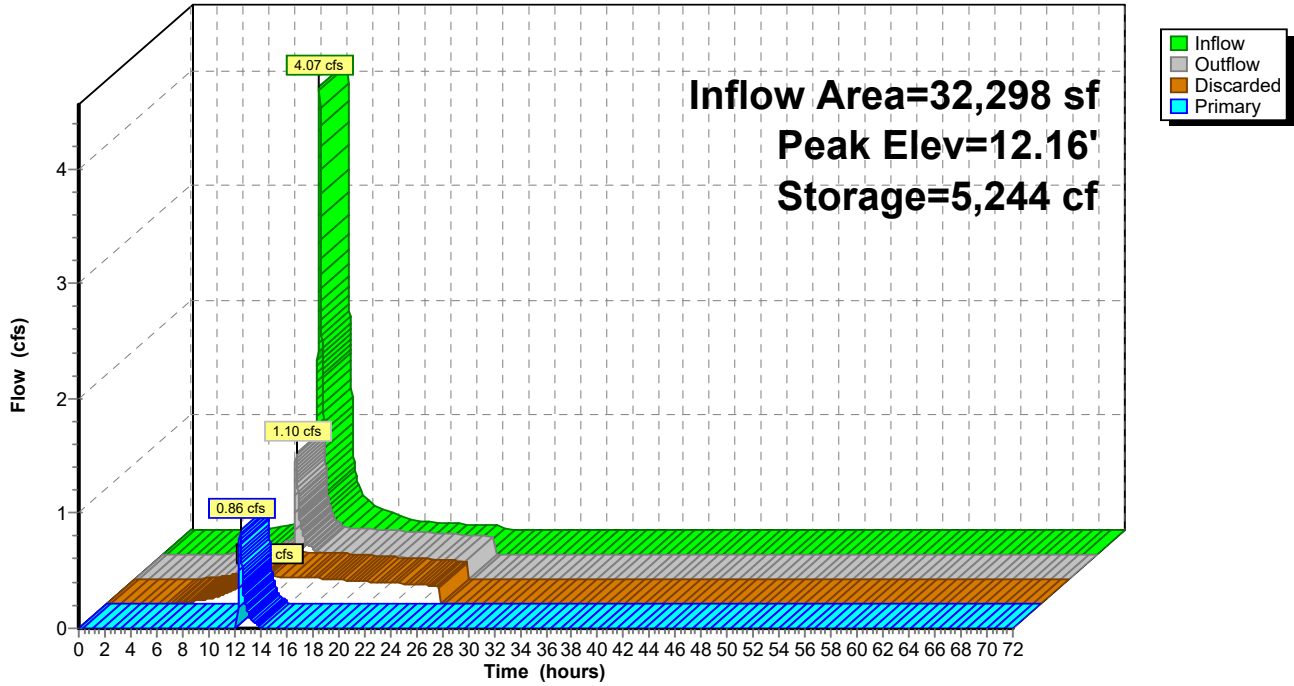

Summary for Link A: POI-A

Inflow Area = 305,609 sf, 22.70% Impervious, Inflow Depth = 1.33" for 25-Year event
Inflow = 7.75 cfs @ 12.13 hrs, Volume= 33,772 cf
Primary = 7.75 cfs @ 12.13 hrs, Volume= 33,772 cf, Atten= 0%, Lag= 0.0 min

Primary outflow = Inflow, Time Span= 0.00-72.00 hrs, dt= 0.01 hrs

Link A: POI-A

Hydrograph

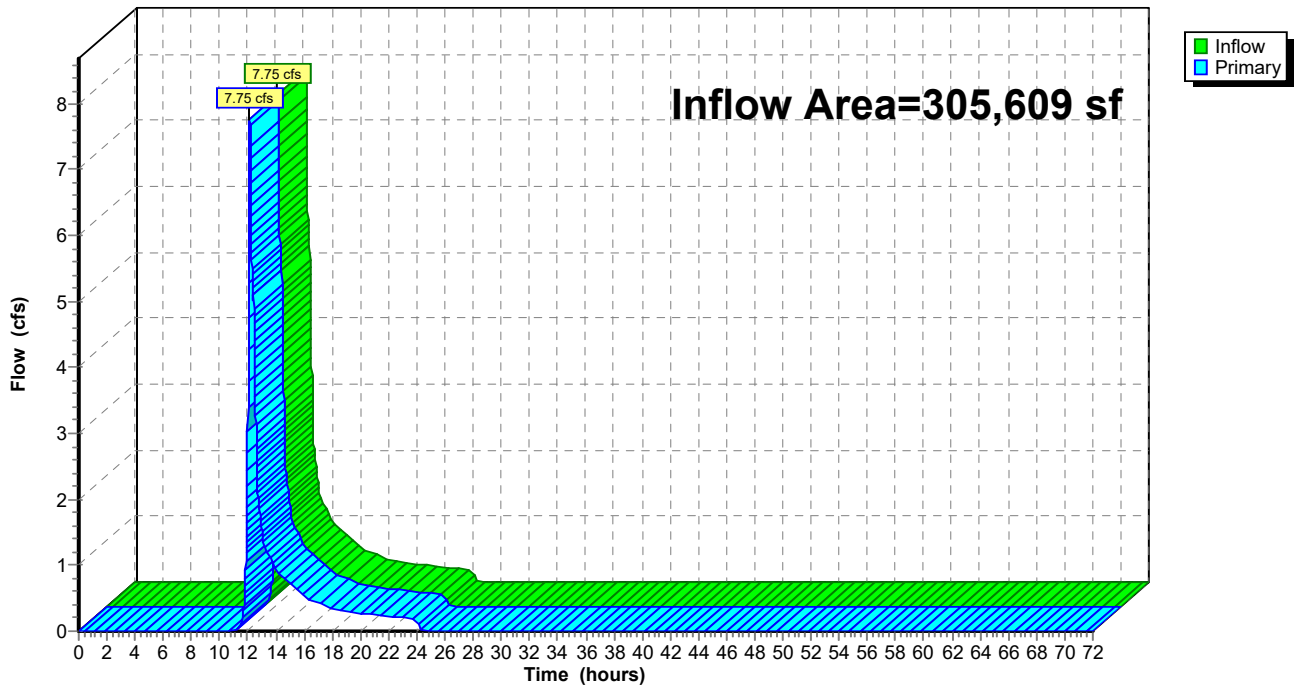

HydroCAD-PR

Prepared by Weston & Sampson

HydroCAD® 10.10-3a s/n 00455 © 2020 HydroCAD Software Solutions LLC

Type III 24-hr 100-Year Rainfall=8.14"

Printed 10/20/2020

Page 40

Time span=0.00-72.00 hrs, dt=0.01 hrs, 7201 points
 Runoff by SCS TR-20 method, UH=SCS, Weighted-CN
 Reach routing by Dyn-Stor-Ind method - Pond routing by Dyn-Stor-Ind method

SubcatchmentA1: SUB-A1 Runoff Area=18,765 sf 27.70% Impervious Runoff Depth=2.88"
 Tc=6.0 min CN=55 Runoff=1.40 cfs 4,504 cf

SubcatchmentA2: SUB-A2 Runoff Area=182,737 sf 10.49% Impervious Runoff Depth=2.34"
 Flow Length=232' Tc=10.0 min CN=50 Runoff=9.18 cfs 35,570 cf

SubcatchmentA3: SUB-A3 Runoff Area=16,685 sf 31.77% Impervious Runoff Depth=3.21"
 Tc=6.0 min CN=58 Runoff=1.41 cfs 4,469 cf

SubcatchmentA4: SUB-A4 Runoff Area=32,298 sf 81.57% Impervious Runoff Depth=6.59"
 Tc=6.0 min CN=87 Runoff=5.45 cfs 17,726 cf

SubcatchmentA5: SUB-A5 Runoff Area=12,207 sf 0.00% Impervious Runoff Depth=1.22"
 Tc=6.0 min CN=39 Runoff=0.27 cfs 1,237 cf

SubcatchmentA6: SUB-A6 Runoff Area=42,917 sf 31.17% Impervious Runoff Depth=3.10"
 Tc=6.0 min CN=57 Runoff=3.49 cfs 11,095 cf

Pond IS-1: IS-1 Peak Elev=12.41' Storage=5,500 cf Inflow=5.45 cfs 17,726 cf
 Discarded=0.25 cfs 13,326 cf Primary=3.34 cfs 4,403 cf Outflow=3.59 cfs 17,729 cf

Link A: POI-A Inflow=17.58 cfs 61,277 cf
 Primary=17.58 cfs 61,277 cf

Total Runoff Area = 305,609 sf Runoff Volume = 74,600 cf Average Runoff Depth = 2.93"
77.30% Pervious = 236,226 sf 22.70% Impervious = 69,383 sf

Summary for Subcatchment A1: SUB-A1

Runoff = 1.40 cfs @ 12.09 hrs, Volume= 4,504 cf, Depth= 2.88"

Runoff by SCS TR-20 method, UH=SCS, Weighted-CN, Time Span= 0.00-72.00 hrs, dt= 0.01 hrs
 Type III 24-hr 100-Year Rainfall=8.14"

Area (sf)	CN	Description
5,198	98	Paved parking, HSG A
7,500	39	>75% Grass cover, Good, HSG A
* 6,067	39	Rubber play assume CN of underlying soils
18,765	55	Weighted Average
13,567		72.30% Pervious Area
5,198		27.70% Impervious Area

Tc (min)	Length (feet)	Slope (ft/ft)	Velocity (ft/sec)	Capacity (cfs)	Description
6.0					Direct Entry, Min Tc = 0.1hrs

Subcatchment A1: SUB-A1

Hydrograph

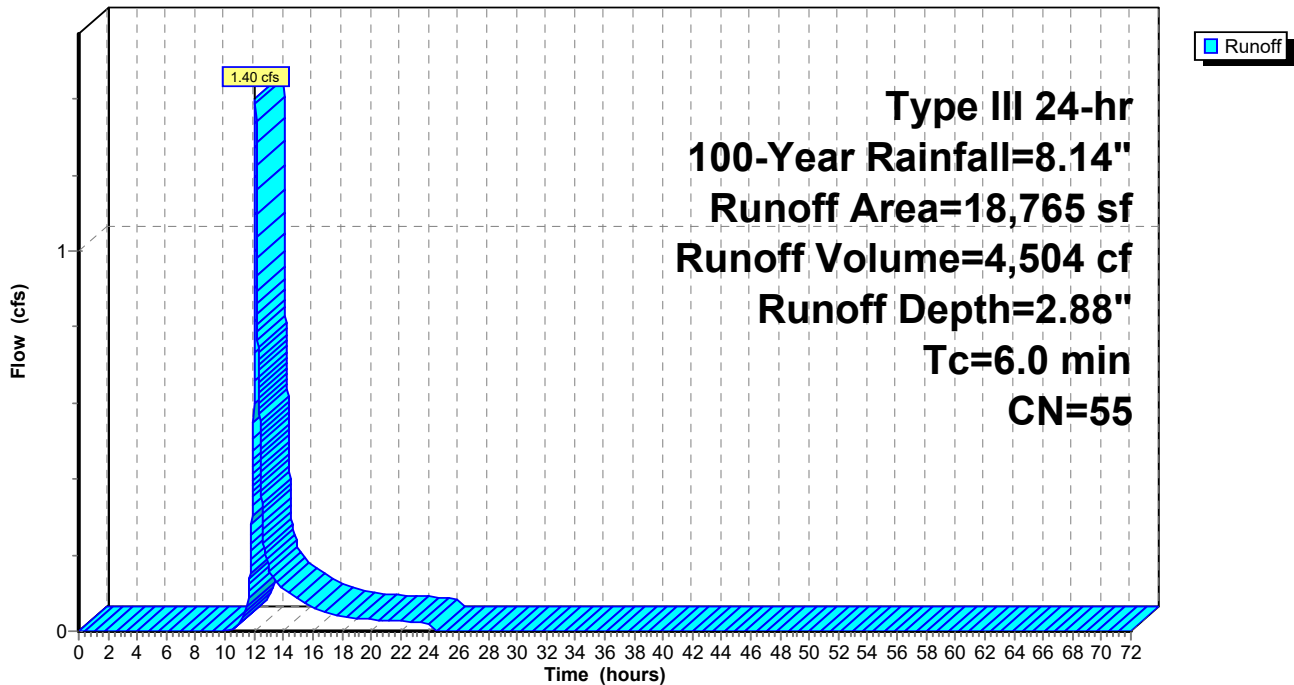

Summary for Subcatchment A2: SUB-A2

Runoff = 9.18 cfs @ 12.15 hrs, Volume= 35,570 cf, Depth= 2.34"

Runoff by SCS TR-20 method, UH=SCS, Weighted-CN, Time Span= 0.00-72.00 hrs, dt= 0.01 hrs
Type III 24-hr 100-Year Rainfall=8.14"

Area (sf)	CN	Description
19,160	98	Paved parking, HSG A
138,300	39	>75% Grass cover, Good, HSG A
25,277	77	Fallow, bare soil, HSG A
182,737	50	Weighted Average
163,577		89.51% Pervious Area
19,160		10.49% Impervious Area

Tc (min)	Length (feet)	Slope (ft/ft)	Velocity (ft/sec)	Capacity (cfs)	Description
9.0	50	0.0060	0.09		Sheet Flow, Sheet Grass: Short n= 0.150 P2= 3.28"
0.2	18	0.0060	1.25		Shallow Concentrated Flow, Shallow 1 Unpaved Kv= 16.1 fps
0.2	85	0.0870	5.99		Shallow Concentrated Flow, Shallow 2 Paved Kv= 20.3 fps
0.6	79	0.0190	2.22		Shallow Concentrated Flow, Shallow 3 Unpaved Kv= 16.1 fps
10.0	232	Total			

Subcatchment A2: SUB-A2

Hydrograph

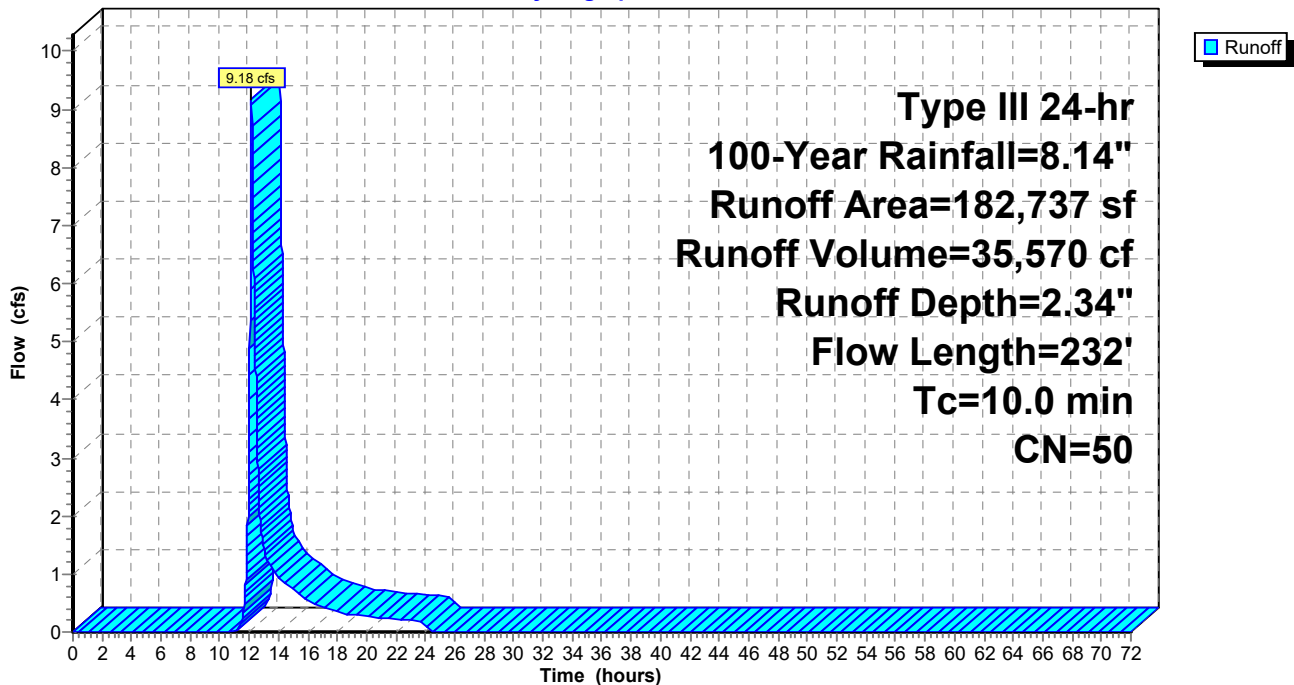

Summary for Subcatchment A3: SUB-A3

Runoff = 1.41 cfs @ 12.09 hrs, Volume= 4,469 cf, Depth= 3.21"

Runoff by SCS TR-20 method, UH=SCS, Weighted-CN, Time Span= 0.00-72.00 hrs, dt= 0.01 hrs
 Type III 24-hr 100-Year Rainfall=8.14"

Area (sf)	CN	Description
5,301	98	Paved parking, HSG A
11,384	39	>75% Grass cover, Good, HSG A
16,685	58	Weighted Average
11,384		68.23% Pervious Area
5,301		31.77% Impervious Area

Tc (min)	Length (feet)	Slope (ft/ft)	Velocity (ft/sec)	Capacity (cfs)	Description
6.0					Direct Entry, Min Tc = 0.1hrs

Subcatchment A3: SUB-A3

Hydrograph

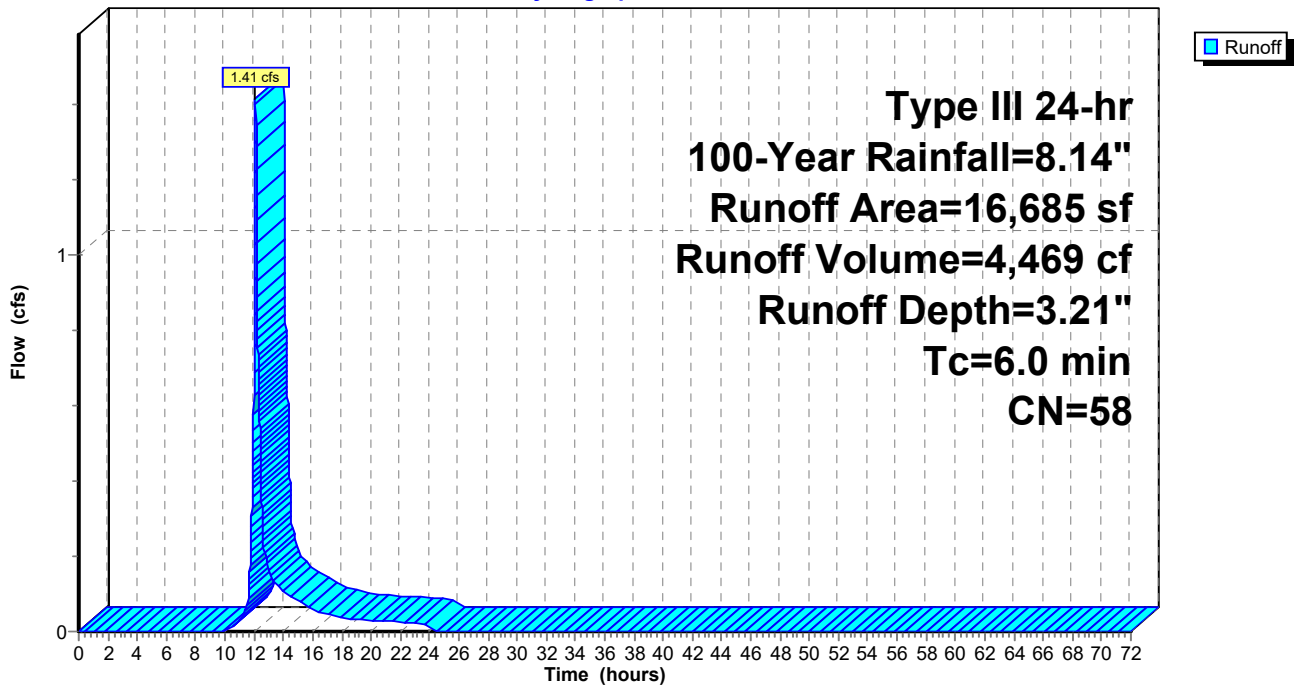

Summary for Subcatchment A4: SUB-A4

Runoff = 5.45 cfs @ 12.08 hrs, Volume= 17,726 cf, Depth= 6.59"

Runoff by SCS TR-20 method, UH=SCS, Weighted-CN, Time Span= 0.00-72.00 hrs, dt= 0.01 hrs
 Type III 24-hr 100-Year Rainfall=8.14"

Area (sf)	CN	Description
26,345	98	Paved parking, HSG A
5,953	39	>75% Grass cover, Good, HSG A
32,298	87	Weighted Average
5,953		18.43% Pervious Area
26,345		81.57% Impervious Area

Tc (min)	Length (feet)	Slope (ft/ft)	Velocity (ft/sec)	Capacity (cfs)	Description
6.0					Direct Entry, Min Tc = 0.1hrs

Subcatchment A4: SUB-A4

Hydrograph

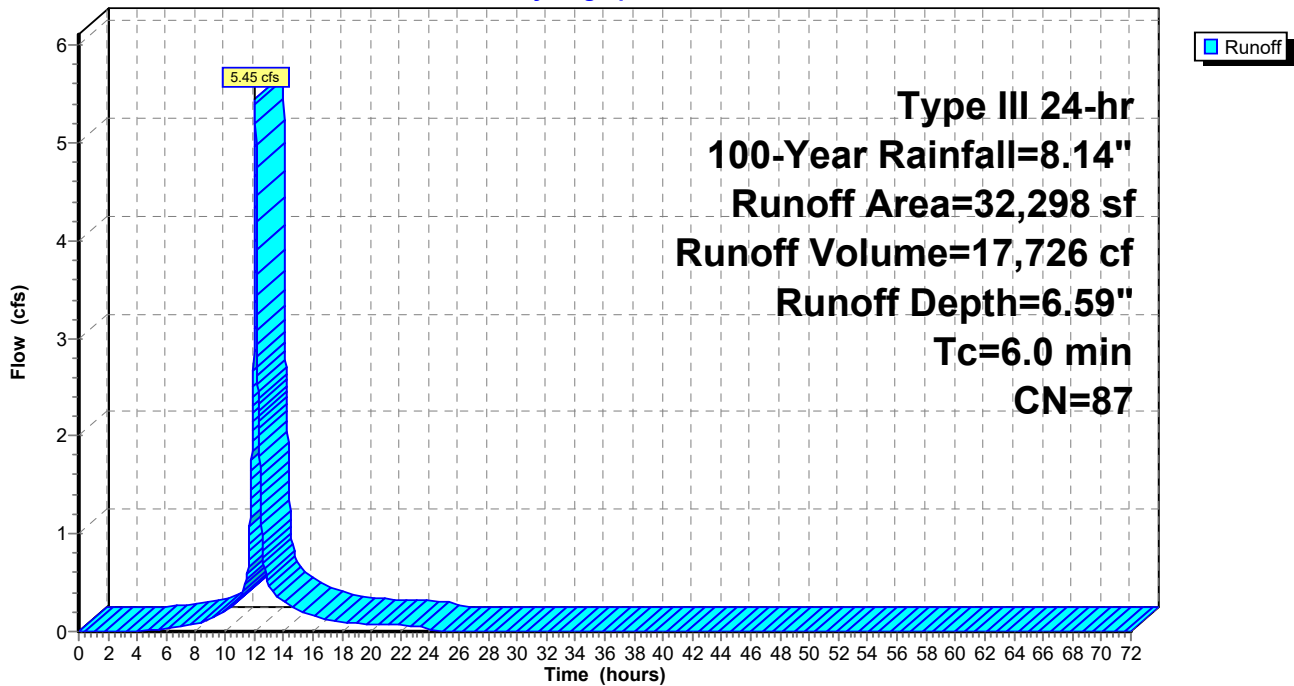

Summary for Subcatchment A5: SUB-A5

Runoff = 0.27 cfs @ 12.12 hrs, Volume= 1,237 cf, Depth= 1.22"

Runoff by SCS TR-20 method, UH=SCS, Weighted-CN, Time Span= 0.00-72.00 hrs, dt= 0.01 hrs
Type III 24-hr 100-Year Rainfall=8.14"

Area (sf)	CN	Description
12,207	39	>75% Grass cover, Good, HSG A
12,207		100.00% Pervious Area

Tc (min)	Length (feet)	Slope (ft/ft)	Velocity (ft/sec)	Capacity (cfs)	Description
6.0					Direct Entry, Min Tc = 0.1hrs

Subcatchment A5: SUB-A5

Hydrograph

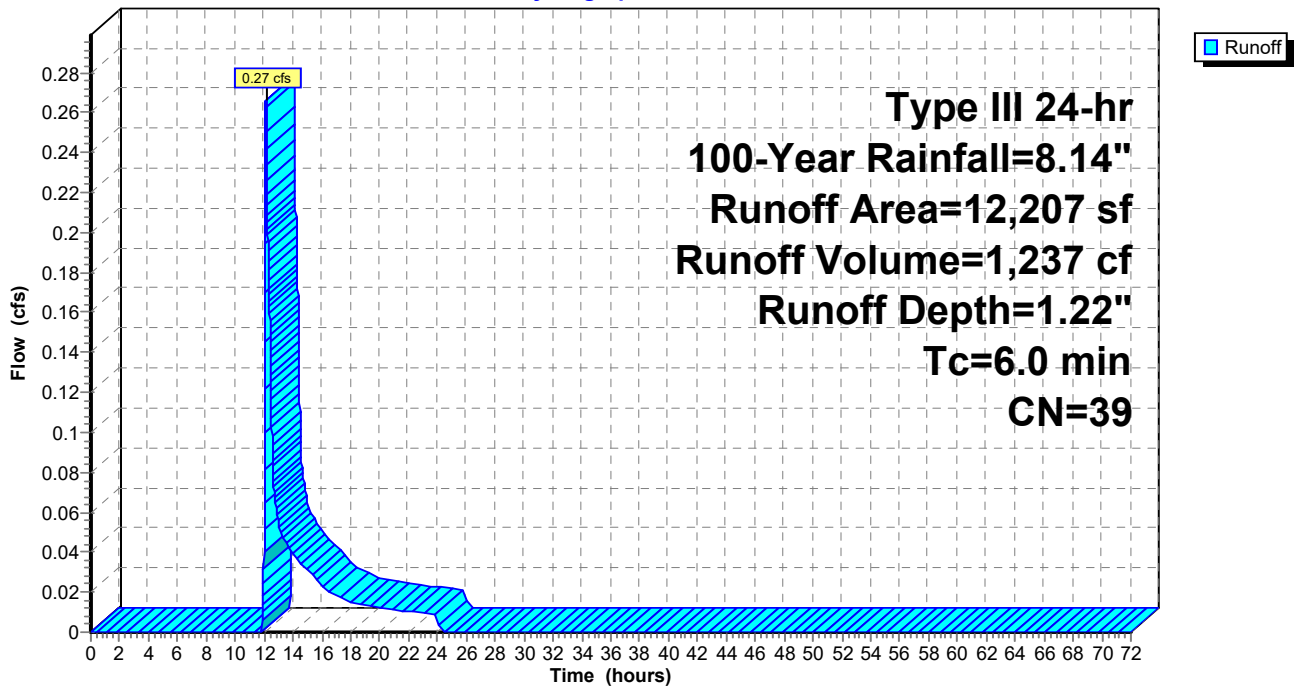

Summary for Subcatchment A6: SUB-A6

Runoff = 3.49 cfs @ 12.09 hrs, Volume= 11,095 cf, Depth= 3.10"

Runoff by SCS TR-20 method, UH=SCS, Weighted-CN, Time Span= 0.00-72.00 hrs, dt= 0.01 hrs
 Type III 24-hr 100-Year Rainfall=8.14"

Area (sf)	CN	Description
13,379	98	Paved parking, HSG A
29,538	39	>75% Grass cover, Good, HSG A
42,917	57	Weighted Average
29,538		68.83% Pervious Area
13,379		31.17% Impervious Area

Tc (min)	Length (feet)	Slope (ft/ft)	Velocity (ft/sec)	Capacity (cfs)	Description
6.0					Direct Entry, Min Tc = 0.1hrs

Subcatchment A6: SUB-A6

Hydrograph

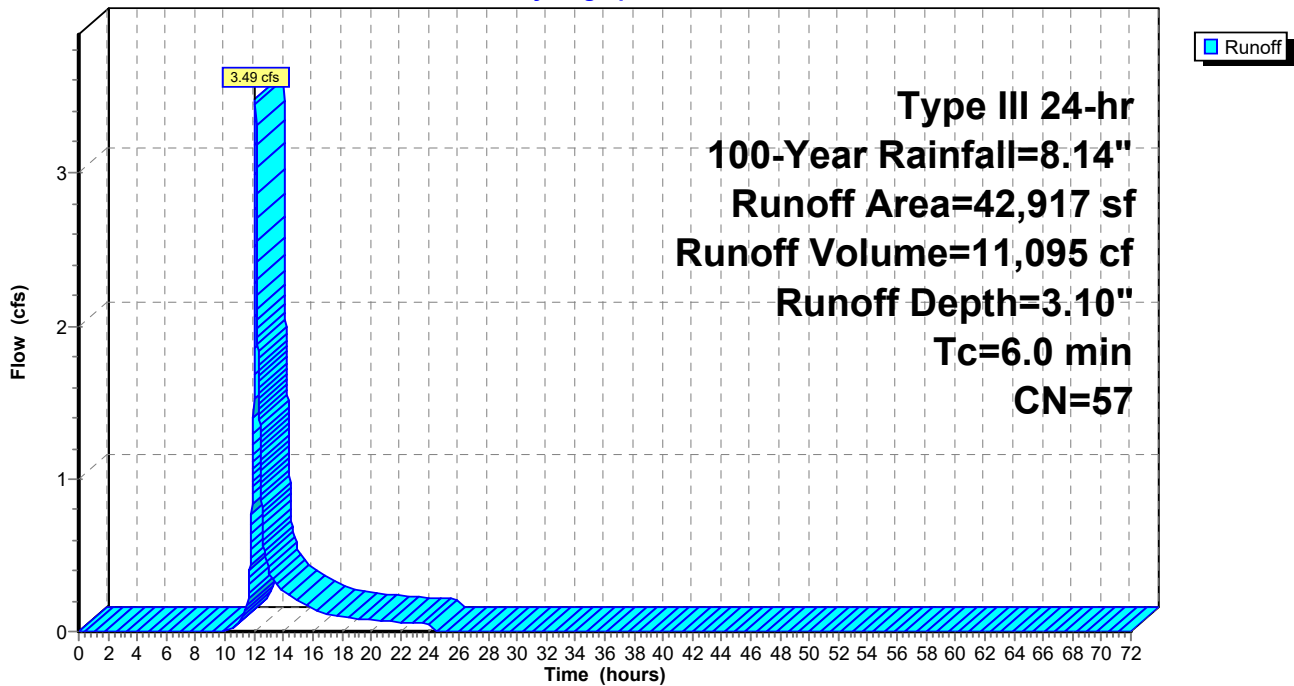

Summary for Pond IS-1: IS-1

Inflow Area = 32,298 sf, 81.57% Impervious, Inflow Depth = 6.59" for 100-Year event
 Inflow = 5.45 cfs @ 12.08 hrs, Volume= 17,726 cf
 Outflow = 3.59 cfs @ 12.17 hrs, Volume= 17,729 cf, Atten= 34%, Lag= 5.4 min
 Discarded = 0.25 cfs @ 12.17 hrs, Volume= 13,326 cf
 Primary = 3.34 cfs @ 12.17 hrs, Volume= 4,403 cf

Routing by Dyn-Stor-Ind method, Time Span= 0.00-72.00 hrs, dt= 0.01 hrs
 Peak Elev= 12.41' @ 12.17 hrs Surf.Area= 2,619 sf Storage= 5,500 cf

Plug-Flow detention time= (not calculated: outflow precedes inflow)
 Center-of-Mass det. time= 171.7 min (956.2 - 784.4)

Volume	Invert	Avail.Storage	Storage Description
#1A	9.00'	2,381 cf	49.00'W x 53.46'L x 3.50'H Field A 9,168 cf Overall - 3,216 cf Embedded = 5,952 cf x 40.0% Voids
#2A	9.50'	3,216 cf	ADS_StormTech SC-740 +Cap x 70 Inside #1 Effective Size= 44.6"W x 30.0"H => 6.45 sf x 7.12'L = 45.9 cf Overall Size= 51.0"W x 30.0"H x 7.56'L with 0.44' Overlap 70 Chambers in 10 Rows
		5,597 cf	Total Available Storage

Storage Group A created with Chamber Wizard

Device	Routing	Invert	Outlet Devices
#1	Primary	8.10'	12.0" Round Culvert L= 3.0' CPP, square edge headwall, Ke= 0.500 Inlet / Outlet Invert= 8.10' / 8.05' S= 0.0167 '/' Cc= 0.900 n= 0.013 Corrugated PE, smooth interior, Flow Area= 0.79 sf
#2	Device 1	12.00'	4.0' long Sharp-Crested Rectangular Weir 2 End Contraction(s)
#3	Discarded	9.00'	2.410 in/hr Exfiltration over Surface area Conductivity to Groundwater Elevation = 4.00'

Discarded OutFlow Max=0.25 cfs @ 12.17 hrs HW=12.41' (Free Discharge)

↑**3=Exfiltration** (Controls 0.25 cfs)

Primary OutFlow Max=3.33 cfs @ 12.17 hrs HW=12.41' TW=0.00' (Dynamic Tailwater)

↑**1=Culvert** (Passes 3.33 cfs of 7.38 cfs potential flow)

↑**2=Sharp-Crested Rectangular Weir**(Weir Controls 3.33 cfs @ 2.09 fps)

Pond IS-1: IS-1 - Chamber Wizard Field A

Chamber Model = ADS_StormTechSC-740 +Cap (ADS StormTech®SC-740 with cap length)

Effective Size= 44.6"W x 30.0"H => 6.45 sf x 7.12'L = 45.9 cf

Overall Size= 51.0"W x 30.0"H x 7.56'L with 0.44' Overlap

51.0" Wide + 6.0" Spacing = 57.0" C-C Row Spacing

7 Chambers/Row x 7.12' Long +0.81' Cap Length x 2 = 51.46' Row Length +12.0" End Stone x 2 = 53.46' Base Length

10 Rows x 51.0" Wide + 6.0" Spacing x 9 + 12.0" Side Stone x 2 = 49.00' Base Width

6.0" Stone Base + 30.0" Chamber Height + 6.0" Stone Cover = 3.50' Field Height

70 Chambers x 45.9 cf = 3,215.8 cf Chamber Storage

9,167.8 cf Field - 3,215.8 cf Chambers = 5,952.0 cf Stone x 40.0% Voids = 2,380.8 cf Stone Storage

Chamber Storage + Stone Storage = 5,596.6 cf = 0.128 af

Overall Storage Efficiency = 61.0%

Overall System Size = 53.46' x 49.00' x 3.50'

70 Chambers

339.5 cy Field

220.4 cy Stone

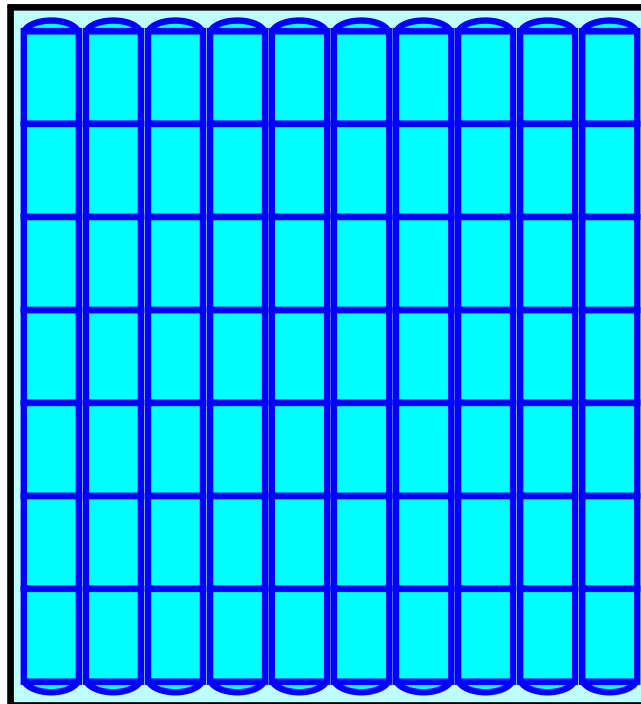

Pond IS-1: IS-1

Hydrograph

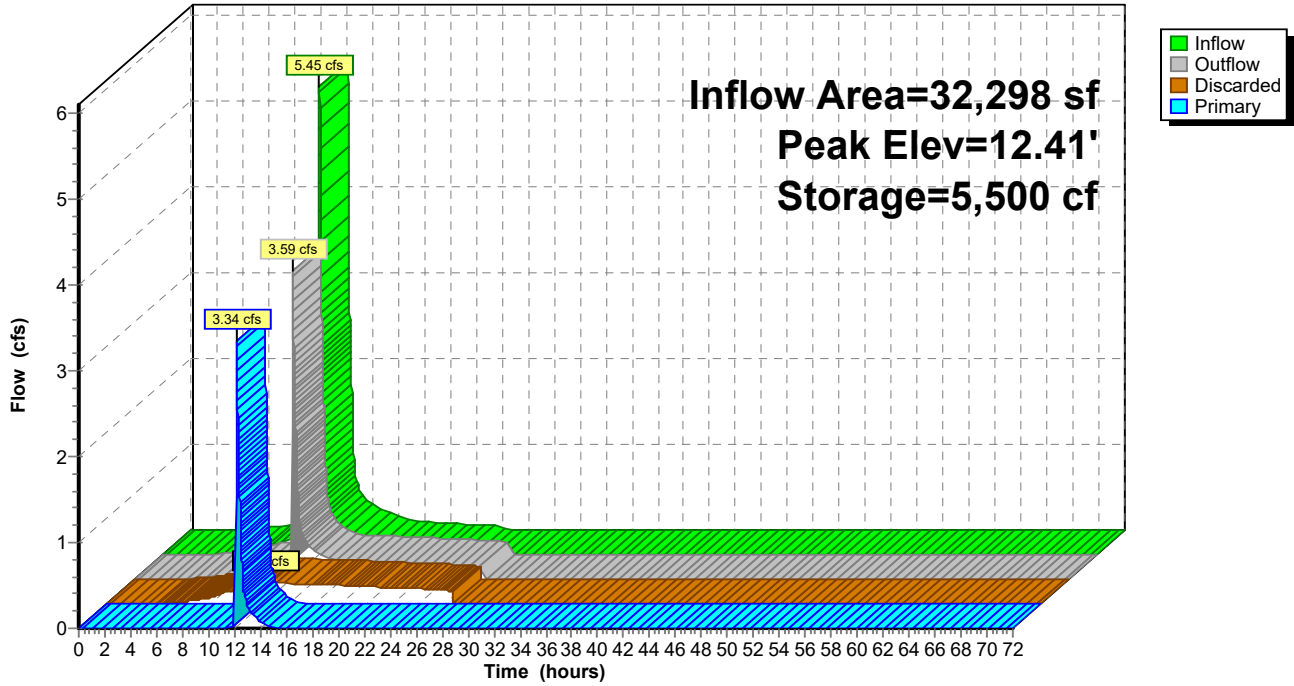

Summary for Link A: POI-A

Inflow Area = 305,609 sf, 22.70% Impervious, Inflow Depth = 2.41" for 100-Year event
Inflow = 17.58 cfs @ 12.15 hrs, Volume= 61,277 cf
Primary = 17.58 cfs @ 12.15 hrs, Volume= 61,277 cf, Atten= 0%, Lag= 0.0 min

Primary outflow = Inflow, Time Span= 0.00-72.00 hrs, dt= 0.01 hrs

Link A: POI-A

Hydrograph

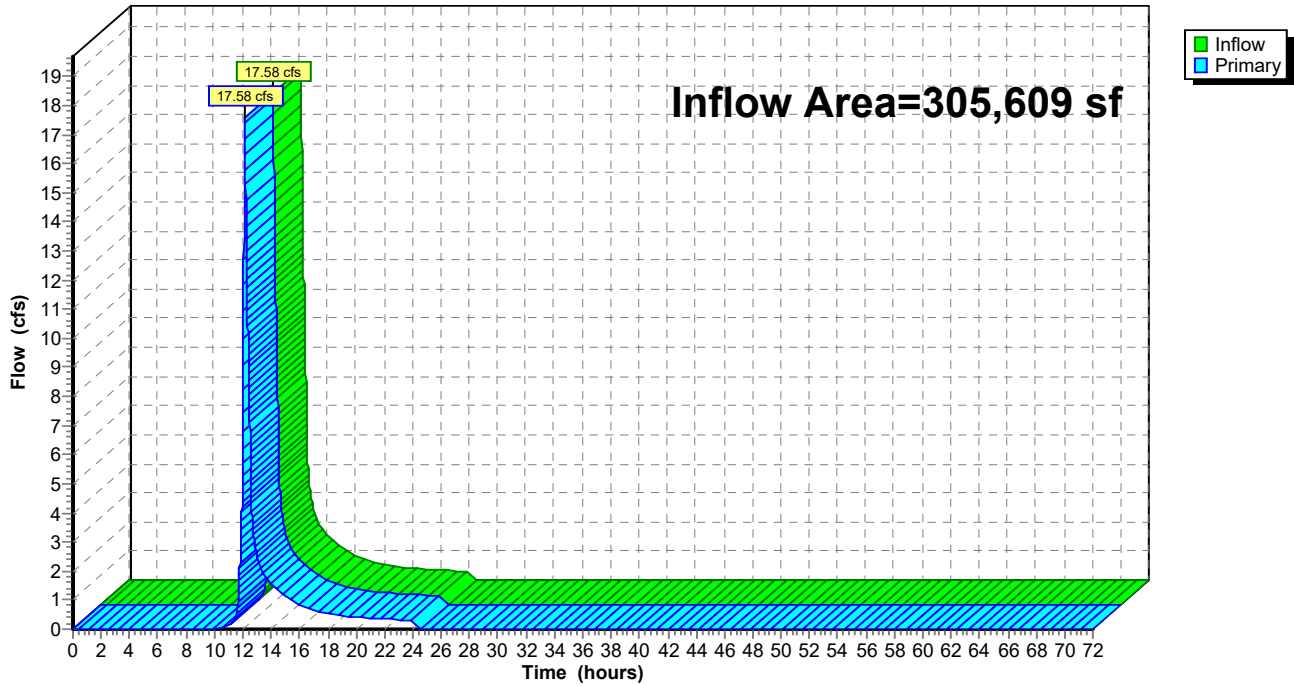

Attachment E - Calculations

Boston - McConnell Park Recharge Calculation

Required Recharge

Area Summary	
	Area (SF)*
Existing Impervious	58,865
Proposed Impervious	69,383
Required Recharge Area (<i>Proposed - Existing</i>)	10,518

* Areas calculated in HydroCAD

Note: Site consists of HSG A soils.

Hydrologic Soil Group Summary		
Group	Target Depth Factor (in)	Area (SF)
A	0.6	10,518
B	0.35	0
C	0.25	0
D	0.1	0

Required Recharge (*Rv*) Calculation:

$$Rv = \text{Target Depth Factor} \times \Delta \text{ Impervious Area}$$

$$Rv = 0.6 \times (1/12) \times 10,518$$

$$Rv = 526 \text{ CF}$$

Proposed Recharge Summary

Location	Volume (CF)*	Description
North of Proposed Parking Lot	5,073	Infiltration System (IS-1)
Total	5,073	

$$Rv = 526 \text{ CF}$$

$$\text{Provided recharge} = 5,073 \text{ CF}$$

Recharge Requirement is met.

Determine Drawdown Time

Saturated Hydraulic Conductivity (Rawls Rate):	4.21
Bottom Area of Infiltration Basin:	3,425
Drawdown Time:	4.2

*Note: Volume numbers listed above reflect static volume available in recharge systems. Actual volume of recharged water will be much higher due to dynamic action reflected in the HydroCAD analysis.

Stage-Area-Storage for Pond IS-1: IS-1

Elevation (feet)	Surface (sq-ft)	Storage (cubic-feet)	Elevation (feet)	Surface (sq-ft)	Storage (cubic-feet)
9.00	2,619	0	11.60	2,619	4,580
9.05	2,619	52	11.65	2,619	4,652
9.10	2,619	105	11.70	2,619	4,722
9.15	2,619	157	11.75	2,619	4,787
9.20	2,619	210	11.80	2,619	4,849
9.25	2,619	262	11.85	2,619	4,908
9.30	2,619	314	11.90	2,619	4,965
9.35	2,619	367	11.95	2,619	5,019
9.40	2,619	419	12.00	2,619	5,073
9.45	2,619	471	12.05	2,619	5,125
9.50	2,619	524	12.10	2,619	5,178
9.55	2,619	632	12.15	2,619	5,230
9.60	2,619	740	12.20	2,619	5,282
9.65	2,619	848	12.25	2,619	5,335
9.70	2,619	955	12.30	2,619	5,387
9.75	2,619	1,062	12.35	2,619	5,439
9.80	2,619	1,169	12.40	2,619	5,492
9.85	2,619	1,275	12.45	2,619	5,544
9.90	2,619	1,382	12.50	2,619	5,597
9.95	2,619	1,487			
10.00	2,619	1,593			
10.05	2,619	1,697			
10.10	2,619	1,802			
10.15	2,619	1,905			
10.20	2,619	2,009			
10.25	2,619	2,112			
10.30	2,619	2,214			
10.35	2,619	2,316			
10.40	2,619	2,417			
10.45	2,619	2,517			
10.50	2,619	2,617			
10.55	2,619	2,717			
10.60	2,619	2,815			
10.65	2,619	2,913			
10.70	2,619	3,010			
10.75	2,619	3,106			
10.80	2,619	3,202			
10.85	2,619	3,297			
10.90	2,619	3,390			
10.95	2,619	3,483			
11.00	2,619	3,575			
11.05	2,619	3,666			
11.10	2,619	3,756			
11.15	2,619	3,845			
11.20	2,619	3,933			
11.25	2,619	4,019			
11.30	2,619	4,103			
11.35	2,619	4,187			
11.40	2,619	4,269			
11.45	2,619	4,349			
11.50	2,619	4,428			
11.55	2,619	4,505			

VOLUME BELOW
LOWEST OUTLET

Boston - McConnell Park
Water Quality Volume Calculation
Oct-20

Required Water Quality Storage
 Proposed Paved Area sf x 1/2" x 1 1/12" = Required WQ Storage CF

Location	Proposed Impervious Area (sqft)	Required WQ Storage (cf)	Provided WQ Storage (cf)	Description
McConnell Park	69,383	2,891	5,073	Infiltration System One (IS-1)

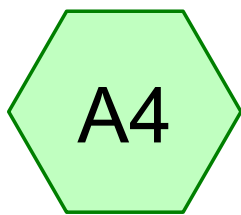

SUB-A4

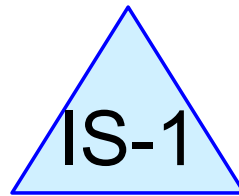

IS-1

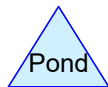
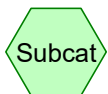

HydroCAD-Isolator Sizing

Prepared by Weston & Sampson

HydroCAD® 10.10-3a s/n 00455 © 2020 HydroCAD Software Solutions LLC

Printed 10/20/2020

Page 2

Rainfall Events Listing

Event#	Event Name	Storm Type	Curve	Mode	Duration (hours)	B/B	Depth (inches)	AMC
1	1"	Type III 24-hr		Default	24.00	1	1.00	2
2	2-Year	Type III 24-hr		Default	24.00	1	3.28	2
3	10-Year	Type III 24-hr		Default	24.00	1	5.16	2
4	25-Year	Type III 24-hr		Default	24.00	1	6.33	2
5	100-Year	Type III 24-hr		Default	24.00	1	8.14	2

HydroCAD-Isolator Sizing

Prepared by Weston & Sampson

HydroCAD® 10.10-3a s/n 00455 © 2020 HydroCAD Software Solutions LLC

Printed 10/20/2020

Page 3

Area Listing (all nodes)

Area (sq-ft)	CN	Description (subcatchment-numbers)
5,953	39	>75% Grass cover, Good, HSG A (A4)
26,345	98	Paved parking, HSG A (A4)
32,298	87	TOTAL AREA

HydroCAD-Isolator Sizing

Prepared by Weston & Sampson

HydroCAD® 10.10-3a s/n 00455 © 2020 HydroCAD Software Solutions LLC

Printed 10/20/2020

Page 4

Soil Listing (all nodes)

Area (sq-ft)	Soil Group	Subcatchment Numbers
32,298	HSG A	A4
0	HSG B	
0	HSG C	
0	HSG D	
0	Other	
32,298		TOTAL AREA

HydroCAD-Isolator Sizing

Prepared by Weston & Sampson

HydroCAD® 10.10-3a s/n 00455 © 2020 HydroCAD Software Solutions LLC

Printed 10/20/2020

Page 5

Ground Covers (all nodes)

HSG-A (sq-ft)	HSG-B (sq-ft)	HSG-C (sq-ft)	HSG-D (sq-ft)	Other (sq-ft)	Total (sq-ft)	Ground Cover
5,953	0	0	0	0	5,953	>75% Grass cover, Good
26,345	0	0	0	0	26,345	Paved parking
32,298	0	0	0	0	32,298	TOTAL AREA

HydroCAD-Isolator Sizing

Prepared by Weston & Sampson

HydroCAD® 10.10-3a s/n 00455 © 2020 HydroCAD Software Solutions LLC

Type III 24-hr 1" Rainfall=1.00"

Printed 10/20/2020

Page 6

Time span=0.00-72.00 hrs, dt=0.05 hrs, 1441 points
Runoff by SCS TR-20 method, UH=SCS, Weighted-CN
Reach routing by Dyn-Stor-Ind method - Pond routing by Dyn-Stor-Ind method

SubcatchmentA4: SUB-A4

Runoff Area=32,298 sf 81.57% Impervious Runoff Depth=0.22"
Tc=6.0 min CN=87 Runoff=0.16 cfs 603 cf

Pond IS-1: IS-1

Peak Elev=9.97' Storage=180 cf Inflow=0.16 cfs 603 cf
Discarded=0.02 cfs 603 cf Primary=0.00 cfs 0 cf Outflow=0.02 cfs 603 cf

Total Runoff Area = 32,298 sf Runoff Volume = 603 cf Average Runoff Depth = 0.22"
18.43% Pervious = 5,953 sf 81.57% Impervious = 26,345 sf

HydroCAD-Isolator Sizing

Prepared by Weston & Sampson

HydroCAD® 10.10-3a s/n 00455 © 2020 HydroCAD Software Solutions LLC

Type III 24-hr 1" Rainfall=1.00"

Printed 10/20/2020

Page 7

Summary for Subcatchment A4: SUB-A4

Runoff = 0.16 cfs @ 12.11 hrs, Volume= 603 cf, Depth= 0.22"

Runoff by SCS TR-20 method, UH=SCS, Weighted-CN, Time Span= 0.00-72.00 hrs, dt= 0.05 hrs
Type III 24-hr 1" Rainfall=1.00"

Area (sf)	CN	Description
26,345	98	Paved parking, HSG A
5,953	39	>75% Grass cover, Good, HSG A
32,298	87	Weighted Average
5,953		18.43% Pervious Area
26,345		81.57% Impervious Area

Tc (min)	Length (feet)	Slope (ft/ft)	Velocity (ft/sec)	Capacity (cfs)	Description
6.0					Direct Entry, Min Tc = 0.1hrs

Subcatchment A4: SUB-A4

Hydrograph

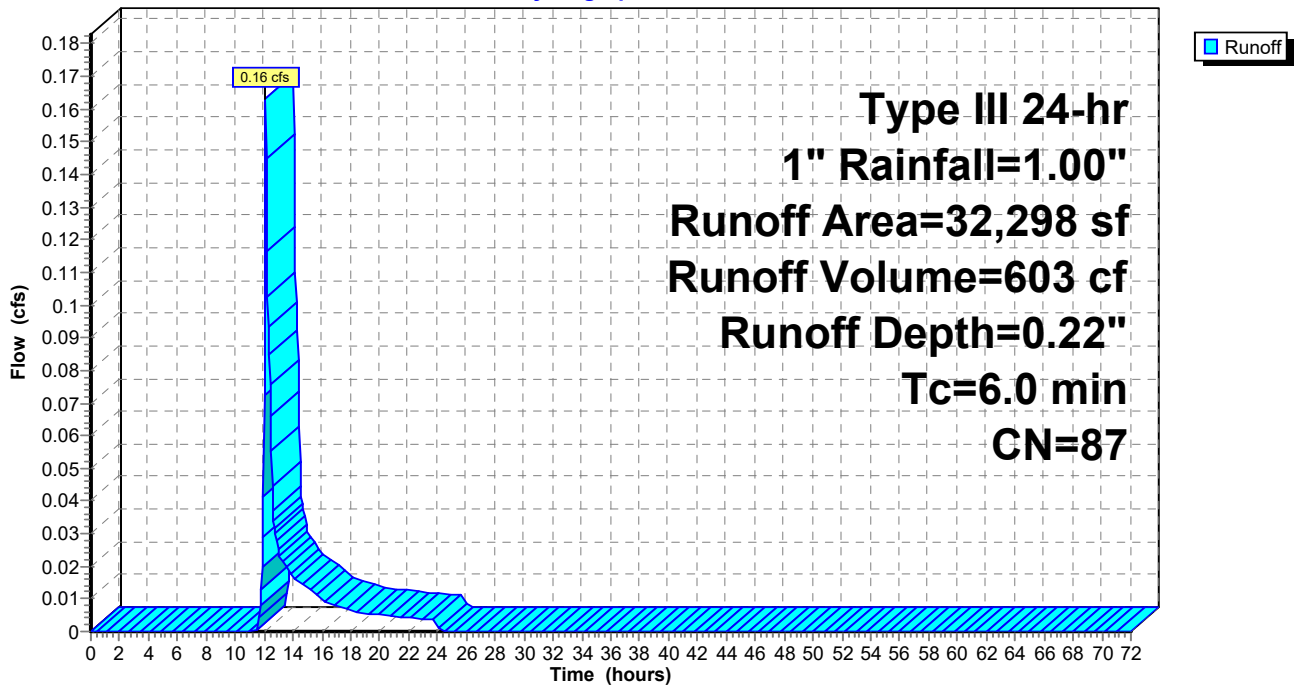

HydroCAD-Isolator Sizing

Prepared by Weston & Sampson

HydroCAD® 10.10-3a s/n 00455 © 2020 HydroCAD Software Solutions LLC

Type III 24-hr 1" Rainfall=1.00"

Printed 10/20/2020

Page 8

Summary for Pond IS-1: IS-1

[87] Warning: Oscillations may require smaller dt or Finer Routing (severity=55)

Inflow Area = 32,298 sf, 81.57% Impervious, Inflow Depth = 0.22" for 1" event
Inflow = 0.16 cfs @ 12.11 hrs, Volume= 603 cf
Outflow = 0.02 cfs @ 13.15 hrs, Volume= 603 cf, Atten= 86%, Lag= 62.3 min
Discarded = 0.02 cfs @ 13.15 hrs, Volume= 603 cf
Primary = 0.00 cfs @ 0.00 hrs, Volume= 0 cf

Routing by Dyn-Stor-Ind method, Time Span= 0.00-72.00 hrs, dt= 0.05 hrs
Peak Elev= 9.97' @ 13.15 hrs Surf.Area= 334 sf Storage= 180 cf

Plug-Flow detention time= (not calculated: outflow precedes inflow)
Center-of-Mass det. time= 74.7 min (959.2 - 884.5)

Volume	Invert	Avail.Storage	Storage Description
#1A	9.00'	339 cf	6.25'W x 53.46'L x 3.50'H Field A 1,169 cf Overall - 322 cf Embedded = 848 cf x 40.0% Voids
#2A	9.50'	322 cf	ADS_StormTech SC-740 +Cap x 7 Inside #1 Effective Size= 44.6"W x 30.0"H => 6.45 sf x 7.12'L = 45.9 cf Overall Size= 51.0"W x 30.0"H x 7.56'L with 0.44' Overlap
		661 cf	Total Available Storage

Storage Group A created with Chamber Wizard

Device	Routing	Invert	Outlet Devices
#1	Discarded	9.00'	2.410 in/hr Exfiltration over Surface area Conductivity to Groundwater Elevation = 4.00'
#2	Primary	10.00'	4.0' long Sharp-Crested Rectangular Weir 2 End Contraction(s)

Discarded OutFlow Max=0.02 cfs @ 13.15 hrs HW=9.97' (Free Discharge)
↑1=Exfiltration (Controls 0.02 cfs)

Primary OutFlow Max=0.00 cfs @ 0.00 hrs HW=9.00' (Free Discharge)
↑2=Sharp-Crested Rectangular Weir(Controls 0.00 cfs)

HydroCAD-Isolator Sizing

Prepared by Weston & Sampson

HydroCAD® 10.10-3a s/n 00455 © 2020 HydroCAD Software Solutions LLC

Type III 24-hr 1" Rainfall=1.00"

Printed 10/20/2020

Page 9

Pond IS-1: IS-1 - Chamber Wizard Field A

Chamber Model = ADS_StormTechSC-740 +Cap (ADS StormTech®SC-740 with cap length)

Effective Size= 44.6"W x 30.0"H => 6.45 sf x 7.12'L = 45.9 cf

Overall Size= 51.0"W x 30.0"H x 7.56'L with 0.44' Overlap

7 Chambers/Row x 7.12' Long +0.81' Cap Length x 2 = 51.46' Row Length +12.0" End Stone x 2 = 53.46' Base Length

1 Rows x 51.0" Wide + 12.0" Side Stone x 2 = 6.25' Base Width

6.0" Stone Base + 30.0" Chamber Height + 6.0" Stone Cover = 3.50' Field Height

7 Chambers x 45.9 cf = 321.6 cf Chamber Storage

1,169.4 cf Field - 321.6 cf Chambers = 847.8 cf Stone x 40.0% Voids = 339.1 cf Stone Storage

Chamber Storage + Stone Storage = 660.7 cf = 0.015 af

Overall Storage Efficiency = 56.5%

Overall System Size = 53.46' x 6.25' x 3.50'

7 Chambers

43.3 cy Field

31.4 cy Stone

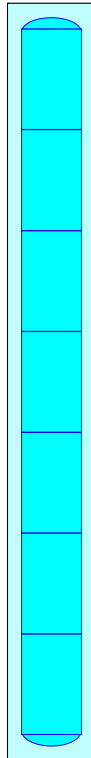

HydroCAD-Isolator Sizing

Prepared by Weston & Sampson

HydroCAD® 10.10-3a s/n 00455 © 2020 HydroCAD Software Solutions LLC

Type III 24-hr 1" Rainfall=1.00"

Printed 10/20/2020

Page 10

Pond IS-1: IS-1

Hydrograph

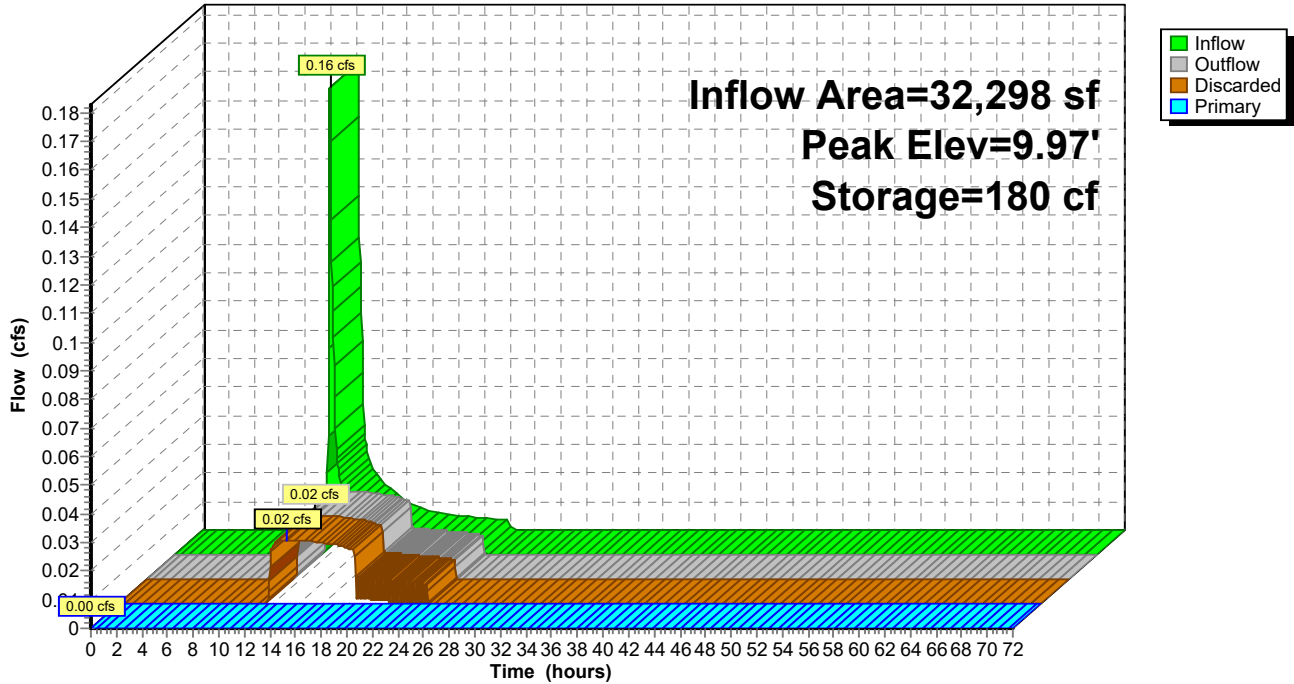

StormTech and Stormwater Quality

StormTech's patented Isolator™ Row is a row of chambers wrapped in a geotextile which filters the stormwater trapping pollutants in the row. The Isolator Row provides a way to inspect and maintain the system.

Isolator Row Detail

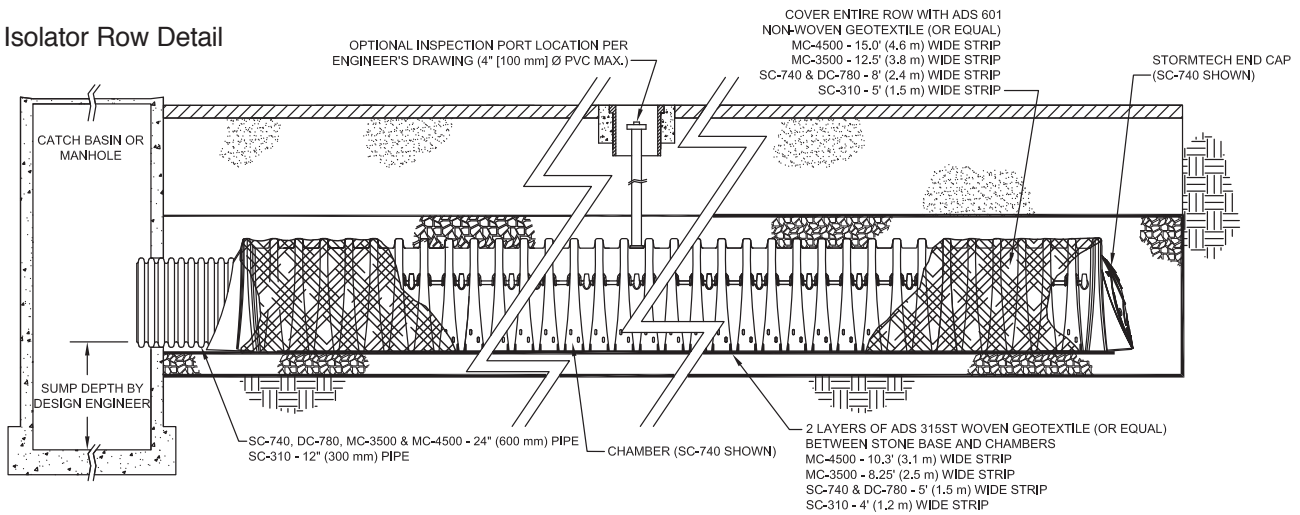

Note: For many applications, the non-woven geotextile over the DC-780, MC-3500 and MC-4500 Isolator Row chambers can be eliminated or substituted with the AASHTO Class 1 woven geotextile. Contact your StormTech representative for assistance.

Isolator Row Field Verification Testing at the University of New Hampshire Stormwater Center

- Field testing (TARP tier II protocol) of the Isolator Row has been ongoing since December 2006.
- Removal efficiencies for TSS have improved as the filter cake has built up on the bottom fabric of the Isolator Row.
- Current data shows a TSS removal efficiency which exceeds 80%.

Removal Efficiency Results:

- Total Suspended Solids = 80%
- Phosphorous = 49%
- Total Petroleum Hydrocarbons = 90%
- Zinc = 53%

This system achieves a removal efficiency of 80% for TSS which meets most municipal recommended levels for water quality treatment.



Inspection and Maintenance

The Isolator Row can be inspected through the upstream manhole or optional inspection port.

Maintenance is easily accomplished with the JetVac process.

The frequency of inspection and maintenance varies by location. Contact StormTech for assistance with inspection and maintenance scheduling.



Technical Memo

Pages: 3

To: Ed Pisowicz

From: Ken Sanok, P.E.

Cc: Engineering Department, Technical Services,
 StormTech Regional Product Managers

Date: 03/5/2010

Subject: Design Guidance for the Isolator Row Weir

Isolator Row

The Isolator Row is typically designed to treat the "first flush" and offers the versatility to be sized on a volume basis or flow rate basis. While the "first flush" will have the highest TSS, nutrient and hydrocarbon loading the unique design of the Isolator Row system continues to filter throughout the entire storm event. An upstream manhole/diversion structure not only provides access to the Isolator Row but typically includes a high flow weir such that the stormwater flow rates or volumes that exceed the capacity of the Isolator Row chambers overtop the weir and discharge through a manifold to the remainder of the chamber bed. There are several methods to divert the "first flush" into the Isolator Row (weirs, varying pipe inverts, etc.). This memo addresses the design of a weir for the Isolator Row diversion structure.

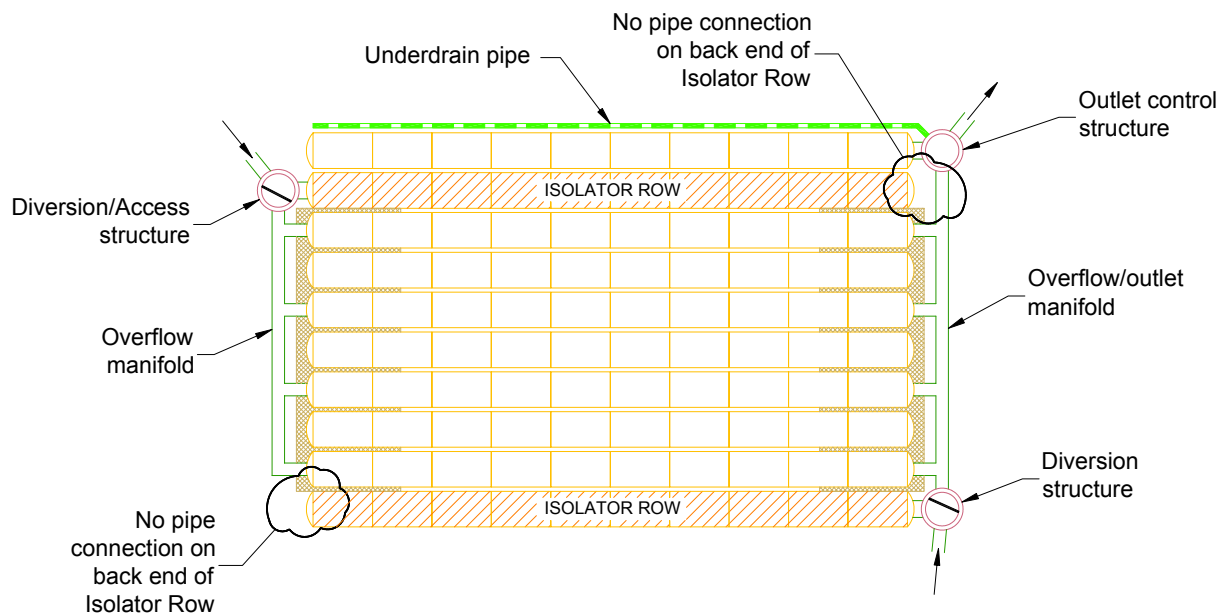

Figure 1 Typical StormTech Chamber Layout with Isolator Row

Structure Placement

The diversion/access structure must be placed directly in front of the Isolator Row and must be connected by a 24" pipe to the SC-740, DC-780 and MC-3500 chambers and a 12" pipe to the SC-310 chamber. The structure will typically have a weir installed and a minimum size of 48 inches is recommended to allow access to the Isolator Row. The design engineer may select a smaller size structure for shallow systems with low flow rates. The actual size of the structure will vary based on the weir design, pipe sizes, pipe angles and design flow rate.

Diversion Weir

The weir is situated to divert the runoff initially into the Isolator Row. The maximum weir crest elevation is determined by subtracting the head required to pass the peak flow from the maximum allowable water surface elevation. Typically the weir crest elevation ranges from the midpoint of the chamber up to the top of the chamber (see figure 2). The design of the weir is performed in several steps. The desired sized structure is drawn on the engineer's plans with the pipe connections. A weir is drawn in and the length is determined. The design engineer then determines the allowable water surface elevation over the weir crest in the structure (typically it is set at the same elevation as the top of the stone above the chambers). The weir crest elevation is then estimated. Start by assuming the elevation of the weir crest is at the same elevation as the top of the chambers. Thus the approach head (H) is the distance from the weir crest to the allowable water surface elevation.

The equation of a sharp crested weir can be written as follows ^[1]:

$$Q = C \sqrt{2g} LH^{3/2}$$

$$C = 0.40 + 0.05 \frac{H}{P}$$

Q = flow rate (cfs)

C = discharge coefficient

L = length of weir (ft)

H = approach head on the crest (ft)

P = height of crest above channel bottom (ft)

g = gravity (32.2 ft/s²)

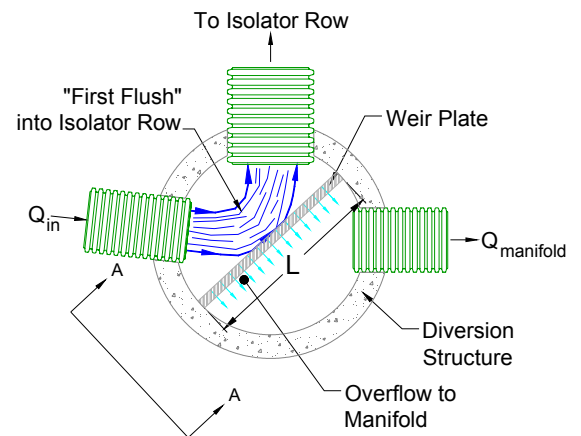

Figure 2A, Plan View of Diversion Structure

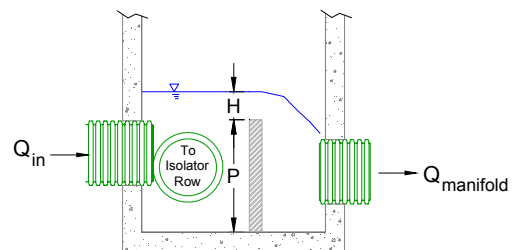

Figure 2B, Section A-A of Diversion Structure

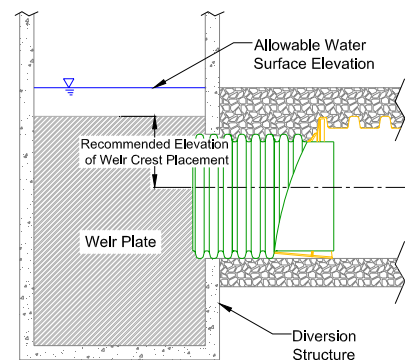

Figure 2C, Profile of Diversion Structure and Isolator Row

The flow over the weir can be calculated using these equations. This calculated flow is then compared to the design flow rate entering the structure. If this calculated flow is greater than the design flow rate then the weir is sufficient to pass the flows. If not, then the weir crest can be lowered and the calculations repeated. As mentioned previously StormTech recommends the weir crest be set between the top of the chamber and the midpoint of the chamber (see figure 2C). If the lowered crest cannot meet the design flow rate a larger structure can be analyzed which allows for a longer weir crest.

Other Considerations

StormTech does not have any specifications for the material or structural design of the weir. It is the responsibility of the design engineer to ensure a material/design selected is adequate for the project design parameters. StormTech has found that aluminum weirs work well as the Isolator Row diversion weir.

Due to the confined nature of the structures it is possible that the weir will be suppressed and/or contracted. The design engineer must be aware of this and incorporate it into the design if deemed necessary.

- [1] Cassidy, J.J, Chaudhry, M.H., and Roberson, J.A., Hydraulic Engineering, 1st ed., Houghton Mifflin, Boston, 1988



PAUL R. LEPAGE
GOVERNOR

STATE OF MAINE
DEPARTMENT OF
ENVIRONMENTAL PROTECTION



PAUL MERCER
COMMISSIONER

July 29, 2016

StormTech, A Division of ADS, Inc.
70 Inwood Road, Suite 3
Rocky Hill, CT 06067
ATTN: David Mailhot P.E.

Dear Mr. Mailhot,

This letter replaces the letter dated March 22, 2016. It includes a slight modification in section 1 to clarify sizing requirements.

The Stormtech Isolator Row was approved by the Department of Environmental Protection (Department) in September 2009 for use as a pre-treatment row before a subsurface underdrained filter system as described in Chapter 7.3 of Volume III of the Maine Stormwater Management Best Management Practice Manual. The sizing, installation, and maintenance criteria provided in this letter replace the ones given in Chapter 7.3 of Volume III of the Maine Stormwater Management BMP Manual. The Department still authorizes the use of the StormTech Isolator Row as a pre-treatment row meeting the requirements of the General Standards (Section 4.C.) of the Stormwater Management Rules (Chapter 500) provided the system is sized, installed, and maintained in accordance with the following provisions:

1. The number of chambers within the Isolator Row pre-treatment structure must treat, without overflowing, the one-year 24-hour peak flow from the structure's drainage area. To determine the number of chambers, the one-year peak flow rate must be divided by the specific flow rate of the chamber. The acceptable flow rate for each of the Isolator Row chamber sizes are as follow:

Chamber size	Flow Rate
SC-310	0.1 cfs
SC-740 or DC-780	0.2 cfs
MC-3500	0.3 cfs

Additional pre-treatment rows may be added based on site conditions and chamber bed layout provided each row is provided with access manhole and control structures.

2. The Isolator Row must be part of a stormwater management system that conforms to all the requirements of Chapter 7.3 of the Stormwater Management Manual and be fitted with an overflow that bypasses the pretreatment Isolator Row only when the one-year 24-hour peak flow is exceeded, and discharges to a stable outlet or is directed to a detention system/structure that will provide necessary flood storage.
3. The Isolator Row shall be underlain with a bottom surface consisting of two layers of ADS 315 woven geotextile or equivalent; and be covered with one layer of ADS 601T non-woven geotextile or equivalent.
4. The Isolator Row does not provide for the removal of hydrocarbons and should be preceded by a device or practice that will serve this function if the area draining to the Isolator Row is

AUGUSTA
17 STATE HOUSE STATION
AUGUSTA, MAINE 04333-0017
(207) 287-7688 FAX: (207) 287-7826

BANGOR
106 HOGAN ROAD, SUITE 6
BANGOR, MAINE 04401
(207) 941-4570 FAX: (207) 941-4584

PORTLAND
312 CANCO ROAD
PORTLAND, MAINE 04103
(207) 822-6300 FAX: (207) 822-6303

PRESQUE ISLE
1235 CENTRAL DRIVE, SKYWAY PARK
PRESQUE ISLE, MAINE 04769
(207) 764-0477 FAX: (207) 760-3143

web site: www.maine.gov/dep

a likely source of hydrocarbons (i.e. parking lots, roads, drive-through commercial enterprises).

5. The Isolator Row must include an access at both ends for the removal of accumulated sediment and debris.
6. The first year of system maintenance must be provided by the manufacturer to ensure that the system is operating according to the established specifications.
7. Prior to construction, a five-year binding inspection and maintenance contract must be provided for review and approval by the Department, and must be renewed before contract expiration. The contract will be with a professional with knowledge of erosion and stormwater control, including a detailed working knowledge of the proposed system.
8. The overall stormwater management design must meet all Department criteria and sizing specifications and will be reviewed and approved by the Department prior to use.
9. Each project must be reviewed and approved by the manufacturer for proposed use, layout and sizing of the pre-treatment row and for conformance with their design specifications.
10. The pre-treatment row must be installed under the manufacturer's representative supervision.
11. This approval is conditional to on-the-ground experience confirming that the StormTech Isolator Row system's pollutant removal efficiency is appropriate. The "permit shield" provision (Section 14) of the Chapter 500 rules will apply, and the Department will not require the replacement of the system if, with proper maintenance, pollutant removals do not satisfy the General Standard Best Management Practices.

We look forward to working with you as these stormwater management structures are installed on new projects. Questions concerning this decision should be directed to Marianne Hubert at (207) 215-6485 or Jeff Dennis at (207) 215-6376.

Sincerely,

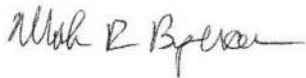

Mark Bergeron, P.E.
Director
Bureau of Land Resources

Cc: Don Witherill, Maine DEP
Gregg Novick, Stormwater Compliance LLC
John Whitehouse, Advanced Drainage Systems, Inc.

INSTRUCTIONS:

Version 1, Automated: Mar. 4, 2008

1. In BMP Column, click on Blue Cell to Activate Drop Down Menu
2. Select BMP from Drop Down Menu
3. After BMP is selected, TSS Removal and other Columns are automatically completed.

Location:

TSS Removal Calculation Worksheet

B BMP ¹	C TSS Removal Rate ¹	D Starting TSS Load*	E Amount Removed (C*D)	F Remaining Load (D-E)
Rain Garden	0.90	1.00	0.90	0.10
Subsurface Infiltration Structure	0.80	0.10	0.08	0.02
	0.00	0.02	0.00	0.02
	0.00	0.02	0.00	0.02
	0.00	0.02	0.00	0.02

Total TSS Removal =

Separate Form Needs to be Completed for Each Outlet or BMP Train

Project:
 Prepared By:
 Date:

*Equals remaining load from previous BMP (E) which enters the BMP

INSTRUCTIONS:

1. In BMP Column, click on Blue Cell to Activate Drop Down Menu
2. Select BMP from Drop Down Menu
3. After BMP is selected, TSS Removal and other Columns are automatically completed.

Version 1, Automated: Mar. 4, 2008

Location:

TSS Removal Calculation Worksheet

B BMP ¹	C TSS Removal Rate ¹	D Starting TSS Load*	E Amount Removed (C*D)	F Remaining Load (D-E)
Deep Sump and Hooded Catch Basin	0.25	1.00	0.25	0.75
Subsurface Infiltration Structure	0.80	0.75	0.60	0.15
	0.00	0.15	0.00	0.15
	0.00	0.15	0.00	0.15
	0.00	0.15	0.00	0.15

Total TSS Removal =

Separate Form Needs to be Completed for Each Outlet or BMP Train

Project:
 Prepared By:
 Date:

*Equals remaining load from previous BMP (E) which enters the BMP

Attachment F - Long Term Pollution Prevention Plan

McConnell Park Boston, MA

To meet the requirements of Standard 4 of the Massachusetts Stormwater Handbook, this Long Term Pollution Prevention Plan is provided to identify the proper procedures of practices for source control and pollution prevention.

Storage and Handling of Oil and other Hazardous Materials

There will be no hazardous materials stored or handled on either site.

Operation and Maintenance of Stormwater Control Structures

Included in Attachment H of this appendix is the Operation and Maintenance plan for this site, which include maintenance of the stormwater BMP's. The Boston Department of Public Works will be responsible for the implementation of the plan.

Landscaping

The landscaped areas will be maintained by the owner.

Septic System

There will be no septic system or wastewater produced on site.

Non-Hazardous Waste Management/Good Housekeeping Practices

All non-hazardous waste shall be stored in designated trash or recycling containers onsite for periodic collection by the local trash collector. The Boston Department of Public Works shall have maintenance staff who monitor the site for the accumulation of trash. Any trash that is seen onsite shall immediately be collected and placed into designated trash or recycling containers. The Boston Department of Public Works maintenance staff shall inspect the site once per week at minimum.

Prohibition of Illicit Discharges

Illicit discharges to the onsite stormwater management system shall be strictly prohibited. Illicit discharges are defined as any direct or indirect non-stormwater discharge to the onsite stormwater system. Requirements related to Illicit Discharges are further detailed in the attached Illicit Discharge Compliance Statement.

**Attachment G - Construction Period Pollution and Erosion
and Sedimentation Control Plan**

Construction Period Pollution Prevention and Erosion and Sedimentation Control Plan

SECTION 1: Introduction

The City of Boston proposes to redevelop McConnell Park off Denny Street. The park in its existing conditions consists of three ballfields on the western portion of the site, a parking area in the middle of the site, and an open grass area to the east. There is also a small shaded play area with assorted play structures on the southern edge of the parcel. The park is bordered to the south by Dorchester Bay, and is bordered to the north by a residential area. Site improvements will include three new ballfields, a new playground, ADA accessibility upgrades, pedestrian walkways, and seating areas to encourage increased public usage of the park. This project will allow the City of Boston to utilize McConnell Park that meets current and future needs while also drawing more recreational activities to the area. Work associated with this project will include but not be limited to paving, grading and installation of drainage infrastructure.

As part of this project, this “Construction Period Pollution Prevention and Erosion and Sedimentation Control Plan” has been created to ensure that no further disturbance to the wetland resource is created during the project.

SECTION 2: Construction Period Pollution Prevention Measures

Best Management Practices (BMPs) will be utilized as Construction Period Pollution Prevention Measures to reduce potential pollutants and prevent any off-site discharge. The objectives of the BMPs for construction activity are to minimize the disturbed areas, stabilize any disturbed areas, control the site perimeter and retain sediment. Both erosion and sedimentation controls and non-stormwater best management measures will be used to minimize site disturbance and ensure compliance with the performance standards of the WPA and Stormwater Standards. Measures will be taken to minimize the area disturbed by construction activities to reduce the potential for soil erosion and stormwater pollution problems. In addition, good housekeeping measures will be followed for the day-to-day operation of the construction site under the control of the contractor to minimize the impact of construction. This section describes the control practices that will be in place during construction activities. Recommended control practices will comply with the standards set in the MA DEP Stormwater Policy Handbook.

2.1 Minimize Disturbed Area and Protect Natural Features and Soil

In order to minimize disturbed areas, work will be completed within well-defined work limits. These work limits are shown on the construction plans. The Contractor shall not disturb native vegetation in the undisturbed wetland area without prior approval from the Engineer. The Contractor will be responsible to make sure that all their workers and any subcontractors know the proper work limits and do not extend their work into the undisturbed areas. The protective measures are described in more detail in the following sections.

2.2 Control Stormwater Flowing onto and through the project

Construction areas adjacent to wetland resources will be lined with compost filter tubes. The tubes will be inspected daily, and accumulated silt will be removed as needed.

2.3 Stabilize Soils

The Contractor shall limit the area of land which is exposed and free from vegetation during construction. In areas where the period of exposure will be greater than two (2) months, mulching, the use of erosion control mats, or other protective measures shall be provided as specified.

The Contractor shall take account of the conditions of the soil where erosion control seeding will take place to ensure that materials used for re-vegetation are adaptive to the sediment control.

2.4 Proper Storage and Cover of Any Stockpiles

The location of the Contractor's storage areas for equipment and/or materials shall be upon cleared portions of the job site or areas to be cleared as a part of this project and shall require written approval of the Engineer.

Adequate measures for erosion and sediment control such as the placement of compost filter tubes around the downstream perimeter of stockpiles shall be employed to protect any downstream areas from siltation.

There shall be no storage of equipment or materials in areas designated as wetlands.

The Engineer may designate one or more areas where the Contractor may store materials used in operations.

2.5 Perimeter Controls and Sediment Barriers

Erosion control lines as described in Section 5 will be utilized to ensure that no sedimentation occurs outside the perimeter of the work area.

2.6 Storm Drain Inlet Protection

There are two catch basins to the north of the guard house on the access drive noted on the plans. Catch basin protection in the form of filtration sac is to be installed on the catch basins prior to start of work on-site.

2.7 Retain Sediment On-Site

The Contractor will be responsible to monitor erosion control measures. Whenever necessary the Contractor will clear sediment from the compost filter tube that have been silted up during construction. Daily monitoring should be conducted using the attached Monitoring Form.

The following good housekeeping practices will be followed on-site during the construction project:

2.8 Material Handling and Waste Management

Materials stored on-site will be stored in a neat, orderly manner in appropriate containers. Materials will be kept in their original containers with the original manufacturer's label. Substances will not be mixed with one another unless recommended by the manufacturer.

Waste materials will be collected and stored in a securely lidded metal container from a licensed management company. The waste and any construction debris from the site

will be hauled off-site daily and disposed of properly. The contractor will be responsible for waste removal. Manufacturer's recommendations for proper use and disposal will be followed for materials. Sanitary waste will be collected from the portable units a minimum of once a week, by a licensed sanitary waste management contractor.

2.9 Designated Washout Areas

The Contractor shall use washout facilities at their own facilities, unless otherwise directed by the Engineer.

2.10 Proper Equipment/Vehicle Fueling and Maintenance Practices

On-site vehicles will be monitored for leaks and receive regular preventative maintenance to reduce the risk of leakage. To ensure that leaks on stored equipment do not contaminate the site, oil-absorbing mats will be placed under oil-containing equipment during storage. Regular fueling and service of the equipment may be performed using approved methods and with care taken to minimize chance of spills. Repair of equipment or machinery within the 100' water resources area shall not be allowed without the prior approval of the Engineer. Any petroleum products will be stored in tightly sealed containers that are clearly labeled with spill control pads/socks placed under/around their perimeters.

2.11 Equipment/Vehicle Washing

The Contractor will be responsible to ensure that no equipment is washed on-site.

SECTION 3: Spill Prevention and Control Plan

The Contractor will be responsible for preventing spills in accordance with the project specifications and applicable federal, state and local regulations. The Contractor will identify a properly trained site employee, involved with the day-to-day site operations to be the spill prevention and cleanup coordinator. The name(s) of the responsible spill personnel will be posted on-site. Each employee will be instructed that all spills are to be reported to the spill prevention and cleanup coordinator.

3.1 Spill Control Equipment

Spill control/containment equipment will be kept in the Work Area. Materials and equipment necessary for spill cleanup will be kept either in the Work Area or in an otherwise accessible on-site location. Equipment and materials will include, but not be limited to, absorbent booms/mats, brooms, dust pans, mops, rags, gloves, goggles, sand, plastic and metal containers specifically for this purpose. It is the responsibility of the Contractor to ensure the inventory will be readily accessible and maintained.

3.2 Notification

Workers will be directed to inform the on-site supervisor of a spill event. The supervisor will assess the incident and initiate proper containment and response procedures immediately upon notification. Workers should avoid direct contact with spilled materials during the containment procedures. Primary notification of a spill should be made to the local Fire Department and Police Departments. Secondary Notification will be to the certified cleanup contractor if deemed necessary by Fire and/or Police personnel. The third level of notification (within 1 hour) is to the DEP or municipality's Licensed Site Professional (LSP). The specific cleanup contractor to be used will be identified by the Contractor prior to commencement of construction activities.

3.3 Spill Containment and Clean-Up Measures

Spills will be contained with granular sorbent material, sand, sorbent pads, booms or all the above to prevent spreading. Certified cleanup contractors should complete spill cleanup. The material manufacturer's recommended methods for spill cleanup will be clearly posted and on-site personnel will be made aware of the procedures and the location of the information and cleanup supplies.

3.4 Hazardous Materials Spill Report

The Contractor will report and record any spill. The spill report will present a description of the release, including the quantity and type of material, date of the spill, circumstances leading to the release, location of spill, response actions and personnel, documentation of notifications and corrective measures implemented to prevent reoccurrence.

This document does not relieve the Contractor of the Federal reporting requirements of 40 CFR Part 110, 40 CFR Part 117, 40 CFR Part 302 and the State requirements specified under the Massachusetts Contingency Plan (M.C.P) relating to spills or other releases of oils or hazardous substances. Where a release containing a hazardous substance or oil in an amount equal to or in excess of a reportable quantity established under either 40 CFR Part 110, 40 CFR Part 117 or 40 CFR Part 302, occurs during a twenty-four (24) hour period, the Contractor is required to comply with the response requirements of the above mentioned regulations. Spills of oil or hazardous material in excess of the reportable quantity will be reported to the National Response Center (NRC).

SECTION 4: Contact Information/Responsible Parties

Owner/Operator:

City of Boston
Department of Public Works
Chris Osgood, Chief of the Streets, Transportation, and Sanitation
1 City Hall Square, Room 603
Boston, MA 02201

Engineer:

James Pearson, PE
Weston & Sampson Engineers, Inc.
55 Walkers Brook Dr #100
Reading, MA 01867
978-532-1900

Site Inspector:

TBD

Contractor:

TBD

SECTION 5: Erosion and Sedimentation Control

The erosion and sedimentation control can be found on the plan drawings and consists of compost filter tubes with siltation sacks on the existing catch basins. Additional measures may be implemented by the contractor at any time during work with the approval of the Engineer.

SECTION 6: Site Development Plan

The Site Development Plan is included in the attached plans.

SECTION 7: Operation and Maintenance of Erosion Control

The erosion control measures will be installed as detailed in the technical specification **01 57 19 Environmental Protection**. If there is a failure to the controls, the Contractor, under the supervision of the Engineer, will be required to stop work until the failure is repaired.

Periodically throughout the work, whenever the Engineer deems it necessary, the sediment that has been deposited against the controls will be removed to ensure that the controls are working properly.

SECTION 8: Inspection Schedule

During construction, the erosion and sedimentation controls will be inspected daily. Once the Contractor is selected, an onsite inspector will be selected to work closely with the Engineer to ensure that erosion and sedimentation controls are in place and working properly. An Inspection Form is included.

Construction Period Pollution Prevention and Erosion and Sedimentation Control Plan

McConnell Park, Boston, MA

Inspection Form

Inspected By: _____ Date: _____ Time: _____

YES	NO	DOES NOT APPLY	ITEM
			Do any erosion/siltation control measures require repair or clean out to maintain adequate function?
			Is there any evidence that sediment is leaving the site and entering the wetlands?
			Are any temporary soil stockpiles or construction materials located in non-approved areas?
			Are on-site construction traffic routes, parking, and storage of equipment and supplies located in areas not specifically designed for them?
			Is there any evidence that sediment is entering subsurface stormwater chamber systems?

Specific location, current weather conditions, and action to be taken:

Other Comments:

Pending the actions noted above I certify that the site is in compliance with the Construction Period Pollution Prevention and Erosion and Sedimentation Control Plan.

Signature: _____ Date: _____

SECTION 01 57 19

ENVIRONMENTAL PROTECTION

PART 1 – GENERAL

1.01 DESCRIPTION:

- A. The work covered by this section of the specifications consists of furnishing all labor, materials, tools and equipment and performing all work required for the prevention of environmental pollution during and as a result of construction operations under this contract.
- B. The requirements set forth in this section of the specifications apply to cross-country areas, river and stream crossings, and construction in and adjacent to wetlands, unless otherwise specifically stated.
- C. All work under this Contract shall be in accordance with the Conservation Commissions' Orders of Conditions as well as any conditional requirements applied, all of which are attached to Section 00 31 43, PERMITS.
- D. Prior to commencement of work, the Contractor shall meet with representatives of the Engineer to develop mutual understandings relative to compliance of the environmental protection program.

1.02 RELATED WORK:

- A. Section 00 31 43, PERMITS
- B. Section 01 14 19.16, DUST CONTROL
- C. Section 01 33 23, SUBMITTALS
- D. Section 31 00 00, EARTHWORK
- E. Section 31 05 13.33, BENTONITE DAMS
- F. Section 31 11 00, CLEARING AND GRUBBING
- G. Section 31 23 19, DEWATERING
- H. Section 31 50 00, SUPPORT OF EXCAVATION
- I. Section 32 92 00, SURFACE RESTORATION OF CROSS COUNTRY AREAS

1.03 SUBMITTALS:

- A. The Contractor shall submit details and literature fully describing environmental protection methods to be employed in carrying out construction activities within 100 feet of wetlands or across areas designated as wetlands.

PART 2 - PRODUCTS

2.01 SILT FENCE:

- A. The silt fence shall consist of a 3-foot wide continuous length sediment control fabric, stitched to a mesh backing, and stapled to preweathered oak posts installed as shown on the drawings. The oak posts shall be 1-1/4-inches by 1-1/4-inches (Minimum Dimension) by 48-inches and shall be tapered. The bottom edge of the silt fence shall be buried as shown on the drawings.
- B. The silt fence shall be DOT Silt Fence PPDM3611, as manufactured by U.S. Silt & Site Supply/Getsco, Concord, NH, or approved equal.
- C. Silt fence properties:

Physical Properties	Test Method	Minimum Value
Grab Strength, lbs.	ASTM-D-4632	124
Grab Elongation, %	ASTM-D-4632	15
Mullen burst, psi	ASTM-D-3786	300
Puncture, lbs.	ASTM-D-4833	65
Trapezoidal Tear, lbs.	ASTM-D-4533	65
UV Resistance ² , % ³	ASTM-D-4355	80@500 hrs.
AOS, US Sieve No.	ASTM-D-4751	30
Flow Rate, gal/min/sq ft	ASTM-D-4491	10
Permittivity,(1/sec)gal/min/sq ft	ASTM-D-4491	0.05 sec ⁻¹

2.02 STRAW BALES:

- A. Straw bales shall consist of certified seed free stems of agricultural grain and cereal crops and shall be free of grasses and legumes. Standard bales shall be 14-inches high, 18- inches wide and 36- to 40-inches long tied with polypropylene twine and weigh within 5 percent of 7 lbs. per cubic ft.

2.03 STRAW WATTLES:

- A. Straw Wattles shall consist of a 100% biodegradable exterior jute or coir netting with 100% wheat straw interior filling as manufactured by GEI Works, Sebastian, Florida (Phone: 772-646-0597; website: www.erosionpollution.com), or approved equal.

2.04 SILT CURTAIN:

- A. The silt curtain shall be a Type-1-Silt-Barrier consisting of 18-ounce vinyl fabric skirt with a 6-inch marine quality floatation device. The skirt shall be ballasted to hang

vertical in the water column by a minimum 3/16-inch galvanized chain. The silt curtain shall extend into the water as shown on the drawings. If necessary, join adjacent ends of the silt curtain by connecting the reinforcing grommets and shackling ballast lines.

2.05 CATCH BASIN PROTECTION:

- A. To trap sediment and to prevent sediment from clogging drainage systems, catch basin protection in the form of a siltation sack (Siltsack as manufactured by ACF Environmental, Inc. or approved equal) shall be provided as approved by the Engineer.

PART 3- EXECUTION

3.01 NOTIFICATION AND STOPPAGE OF WORK:

- A. The Engineer will notify the Contractor in writing of any non-compliance with the provisions of the Order of Conditions. The Contractor shall, after receipt of such notice, immediately take corrective action. Such notice, when delivered to the Contractor or his authorized representative at the site of the work, shall be deemed sufficient for the purpose. If the Contractor fails to act promptly, the Owner may order stoppage of all or part of the work through the Engineer until satisfactory corrective action has been taken. No claim for an extension of time or for excess costs or damage incurred by the Contractor as a result of time lost due to any stop work orders shall be made unless it was later determined that the Contractor was in compliance.

3.02 AREA OF CONSTRUCTION ACTIVITY:

- A. Insofar as possible, the Contractor shall confine his construction activities to those areas defined by the plans and specifications. All land resources within the project boundaries and outside the limits of permanent work performed under this contract shall be preserved in their present condition or be restored to a condition after completion of construction at least equal to that which existed prior to work under this contract.

3.03 PROTECTION OF WATER RESOURCES:

- A. The Contractor shall not pollute streams, lakes or reservoirs with fuels, oils, bitumens, calcium chloride, acids or other harmful materials. It is the Contractor's responsibility to comply with all applicable Federal, State, County and Municipal laws regarding pollution of rivers and streams.
- B. Special measures should be taken to insure against spillage of any pollutants into public waters.

3.04 CONSTRUCTION IN AREAS DESIGNATED AS WETLANDS ON THE DRAWINGS:

- A. Insofar as possible, the Contractor shall make every effort to minimize disturbance within areas designated as wetlands or within 100-feet of wetland resource areas. Total easement widths shall be limited to the widths shown.
- B. The Contractor shall perform his work in such a way that these areas are left in the condition existing prior to construction.
- C. The elevations of areas designated as wetlands shall not be unduly disturbed by the Contractor's operations outside of the trench limits. If such disturbance does occur, the Contractor shall take all measures necessary to return these areas to the elevations which existed prior to construction.
- D. In areas designated as wetlands, the Contractor shall carefully remove and stockpile the top 24 inches of soil. This topsoil material shall be used as backfill for the trench excavation top layer. The elevation of the trench shall be restored to the preconstruction elevations wherever disturbed by the Contractor's operation.
- E. The Contractor shall use a trench box, sheeting or bracing to support the excavation in areas designated as wetlands.
- F. Excavated materials shall not be permanently placed or temporarily stored in areas designated as wetlands. Temporary storage areas for excavated material shall be as required by the Engineer.
- G. The use of a temporary gravel roadway to construct the pipeline in the wetlands area is not acceptable. The Contractor will be required to utilize timber or rubber matting to support his equipment in these areas. The timber or rubber matting shall be constructed in such a way that it is capable of supporting all equipment necessary to install the pipeline. The timber or rubber matting shall be constructed of materials and placed in such a way that when removed the material below the matting will not be unduly disturbed, mixed or compacted so as to adversely affect recovery of the existing plant life.
- H. Bentonite dams shall be placed in wetlands to prevent drainage. Locations for dams are as indicated on the drawings or as required by the Engineer.
- I. During construction, easements within wetlands shall be lined with a continuous straw bale/siltation fence barrier or line of straw wattles (aka compost filter tube, silt/filter sock).

3.05 PROTECTING AND MINIMIZING EXPOSED AREAS:

- A. The Contractor shall limit the area of land which is exposed and free from vegetation during construction. In areas where the period of exposure will be greater than two

- (2) months, temporary vegetation, mulching or other protective measures shall be provided as specified.
- B. The Contractor shall take account of the conditions of the soil where temporary cover crop will be used to insure that materials used for temporary vegetation are adaptive to the sediment control. Materials to be used for temporary vegetation shall be approved by the Engineer.

3.06 LOCATION OF STORAGE AREAS:

- A. The location of the Contractor's storage areas for equipment and/or materials shall be upon cleared portions of the job site or areas to be cleared as a part of this project, and shall require written approval of the Engineer. Plans showing storage facilities for equipment and materials shall be submitted for approval of the Engineer.
- B. No excavated materials or materials used in backfill operations shall be deposited within a minimum distance of one hundred (100) feet of any watercourse or any drainage facility. Adequate measures for erosion and sediment control such as the placement of baled **hay or straw** around the downstream perimeter of stockpiles shall be employed to protect any downstream areas from siltation.
- C. There shall be no storage of equipment or materials in areas designated as wetlands.
- D. The Engineer may designate a particular area or areas where the Contractor may store materials used in his operations.
- E. Storage areas in cross-country locations shall be restored to pre-construction conditions with the planting of native species of trees and shrubs.

3.07 PROTECTION OF LANDSCAPE:

- A. The Contractor shall not deface, injure, or destroy trees or shrubs nor remove or cut them without written authority from the Owner. No ropes, cables, or guys shall be fastened to or attached to any existing nearby trees for anchorages unless specifically authorized by the Engineer. Excavating machinery and cranes shall be of suitable type and be operated with care to prevent injury to trees which are not to be removed, particularly overhanging branches and limbs. The Contractor shall, in any event, be responsible for any damage resulting from such use.
- B. Branches, limbs, and roots shall not be cut except by permission of the Engineer. All cutting shall be smoothly and neatly done without splitting or crushing. When there is unavoidable injury to branches, limbs and trunks of trees, the injured portions shall be neatly trimmed and covered with an application of grafting wax or tree healing paint as directed.
- C. Where, in the opinion of the Engineer, trees may possibly be defaced, bruised, injured, or otherwise damaged by the Contractor's equipment or by his blasting or

other operations, the Engineer may require the Contractor to adequately protect such trees by placing boards, planks, poles or fencing around them. Any trees or landscape feature scarred or damaged by the Contractor's equipment or operations shall be restored as nearly as possible to its original condition at the expense of the Contractor. The Engineer will decide what method of restoration shall be used, and whether damaged trees shall be treated and healed or removed and disposed of under the provisions of Section 31 11 00, CLEARING AND GRUBBING.

- D. Cultivated hedges, shrubs, and plants which could be injured by the Contractor's operations shall be protected by suitable means or shall be dug up, balled and temporarily replanted and maintained. After construction operations have been substantially completed, they shall be replanted in their original positions and cared for until growth is re-established. If cultivated hedges, shrubs, and plants are injured to such a degree as to affect their growth or diminish their beauty or usefulness, they shall be replaced by items of a kind and quality at least equal to that existing at the start of the work.

3.08 CLEARING AND GRUBBING:

- A. The Contractor shall clear and grub only on the Owner's land or the Owner's easements, and only the area required for construction operations, as approved by the Engineer. Removal of mature trees (4-inches or greater DBH) will not be allowed on temporary easements.
- B. The Contractor shall not remove trees in the Owner's temporary easements without permission of the Engineer.

3.09 DISCHARGE OF DEWATERING OPERATIONS:

- A. Any water that is pumped and discharged from the trench and/or excavation as part of the Contractor's water handling shall be filtered by an approved method prior to its discharge into a receiving water or drainage system.
- B. Under no circumstances shall the Contractor discharge water to the areas designated as wetlands. When constructing in a wetlands area, the Contractor shall discharge water from dewatering operations directly to the nearest drainage system, stream, or waterway after filtering by an approved method.
- C. The pumped water shall be filtered through filter fabric and baled hay, a vegetative filter strip or a vegetated channel to trap sediment occurring as a result of the construction operations. The vegetated channel shall be constructed such that the discharge flow rate shall not exceed a velocity of more than 1 foot per second. Accumulated sediment shall be cleared from the channel periodically.

3.10 DUST CONTROL:

- A. During the progress of the work, the Contractor shall conduct his operations and maintain the area of his activities, including sweeping and sprinkling of streets as necessary, to minimize creation and dispersion of dust. If the Engineer decides it is necessary to use calcium chloride for more effective dust control, the Contractor shall furnish and spread the material, as directed. Calcium chloride shall be as specified under Section 01 14 19.16, DUST CONTROL.
- B. Calcium Chloride shall not be used for dust control within a drainage basin or in the vicinity of any source of potable water.

3.11 SEPARATION AND REPLACEMENT OF TOPSOIL:

- A. Topsoil shall be carefully removed from cross-country areas where excavations are to be made, and separately stored to be used again as required. The topsoil shall be stored in an area acceptable to the Engineer and adequate measures shall be employed to prevent erosion of said material.

3.12 BALED HAY OR STRAW:

- A. To trap sediment and to prevent sediment from clogging drainage systems, baled straw shall be used where shown on the drawings. Care shall be taken to keep the bales from breaking apart. The bales should be securely staked to prevent overturning, flotation, or displacement. All deposited sediment shall be removed periodically. Straw bales shall not be placed within a waterway during construction of the pipeline crossing.

3.13 ERECTION AND MAINTENANCE OF SILT FENCE:

- A. Where indicated on the drawings or where required by the Engineer, the Contractor shall erect and maintain a temporary silt fence. In areas designated as wetlands, the Contractor shall line the limits of the construction easement with a silt fence. The silt fence shall be used specifically to contain sediment from runoff water and to minimize environmental damage caused by construction.

3.14 SURFACE RESTORATION OF CROSS COUNTRY AREAS:

- A. Plantings detailed in Section 32 92 00 shall be conducted when construction of the pipeline has been completed within the areas designated. A one-year guarantee of maintenance will be required on these plantings to ensure that they establish in the area.

3.15 CATCH BASIN PROTECTION:

- A. Catch basin protection shall be used for every catch basin, shown on the plans or as required by the Engineer, to trap sediment and prevent it from clogging drainage systems and entering wetlands. Siltation sack shall be securely installed under the catch basin grate. Care shall be taken to keep the siltation sack from breaking apart

or clogging. All deposited sediment shall be removed periodically and at times prior to predicted precipitation to allow free drainage flow. Prior to working in areas where catch basins are to be protected, each catch basin sump shall be cleaned of all debris and protected. The Contractor shall properly dispose of all debris at no additional cost to the Owner.

- B. All catch basin protection shall be removed by the Contractor after construction is complete.

3.16 STRAW WATTLES:

- A. The wattles will be placed in a shallow trench (2-3 inches deep) and staked in the ground using wooden stakes driven at 4-foot intervals. The wooden stakes will be placed at a minimum depth of 24-inches into the ground.
- B. The wattles shall be regularly inspected and before and after every forecasted major weather event. All deposited sediment shall be removed and not allowed to accumulate to the top of the wattles. Wattles damaged during construction shall be repaired or replaced as required by the Engineer at no additional cost to the Owner.
- C. The Contractor shall remove all wattles after construction is completed.

END OF SECTION

Document1

Attachment H - Long Term Operations & Maintenance Plan

1.0 Introduction

The following document has been written to comply with the stormwater guidelines set forth by the Massachusetts Department of Environmental Protection (MassDEP). The intent of these guidelines is to encourage Low Impact Development techniques to improve the quality of the stormwater runoff. These techniques, also known as Best Management Practices (BMPs) collect, store, and treat the runoff before discharging to adjacent environmental resources.

2.0 Purpose

This Operation and Maintenance Plan (O&M Plan) is intended to provide a mechanism for the consistent inspection and maintenance of each BMP installed on the project site. Included in this O&M Plan is a description of each BMP type and an inspection form for each BMP. The City of Boston is the owner and operator of the system and is responsible for its upkeep and maintenance. This work will be funded on an annual basis through the owner's operating budget.

In the event the Owner sells the property, it is the Owner's responsibility to transfer this plan as well as the past three years of operation and maintenance records to the new property owner.

3.0 BMP Description and Locations

3.1 Grassed Areas

There are several grassed areas throughout the site. These grassed areas are intended to slow runoff velocities and promote infiltration of stormwater.

3.2 Pea Stone Diaphragms

The pea stone diaphragms are pre-treatment devices to remove TSS from stormwater prior to entering the raingardens.

3.3 Bio-Retention Basins

The bio-retention areas mitigate peak runoff rates and filters the stormwater to provide treatment, significantly reducing TSS as well as phosphorus, nitrogen and heavy metals.

3.4 Subsurface Infiltration Structures

There is one subsurface infiltration system on the site to the north of the proposed parking lot that will receive stormwater. This structure provides for stormwater detention to mitigate peak runoff rates from the site. The structure also significantly mitigates TSS.

3.5 Stormtech Isolator Row

The subsurface chamber system will contain a Stormtech Isolator Row for TSS removal. The Isolator Row consists of Stormtech SC-740 stormwater chambers wrapped in two layers of geotextile fabric.

3.6 Outlet Control Structure

The outlet control structure is used to control discharges from captured stormwater. It releases the water in a controlled manner to control peak discharges.

3.7 Deep Sump Catch Basins

Deep sump catch basins will be located throughout the site and used as pre-treatment before entering the infiltration basin. The deep sump catch basins are designed to remove trash, debris, and coarse sediment from the stormwater runoff.

4.0 Inspection, Maintenance Checklist and Schedule

4.1 Grassed Areas

All sediment and debris should be removed and disposed of according to local, state, and federal regulations. During the growing season, vegetation should not exceed six inches in height, and should be mowed as necessary. Any grassed areas in close proximity to any areas that use salt in deicing applications should be re-seeded in the spring. Bare spots should be re-seeded as needed.

4.2 Pea Stone Diaphragms

The pea stone diaphragm shall be inspected twice a year, once in the spring and once in the fall. Trash and debris shall be removed and missing pea stone shall be replaced as necessary. Once per year, the pea stone must be removed from the trench to allow for removal of sediments.

4.3 Bio-Retention Basins

Premature failure of bioretention areas is a significant problem caused by lack of regular maintenance. Careful attention must be paid while plantings are being established and seasonal landscaping maintenance is required thereafter. Maintenance shall be conducted in accordance with the following schedule:

Activity	Time of Year	Frequency
Inspect & remove trash	Year round	Monthly
Mulch	Spring	Annually
Remove dead vegetation	Fall or Spring	Annually
Replace dead vegetation	Spring	Annually
Prune	Spring or Fall	Annually
Replace entire media & all vegetation	Late Spring/early Summer	As needed*

*Paying careful attention to pretreatment and operation & maintenance can extend the life of the soil media

Basin inspection should include checking for rilling and other signs of erosion. When encountered, repairs shall be made immediately. Debris and litter should be removed while inspecting for erosion.

Care must be taken to maintain the plants in the basin. Salt use must be restricted where runoff flows to the bioretention areas to maintain the plantings.

4.4 Stormtech Subsurface Chamber System

Stormtech subsurface chambers shall be inspected every three months for the first year, then timed thereafter based upon the depth of sediment build up witnessed in the previous inspections. Inspection ports shall be located strategically throughout the isolator row system. When sediment is observed, the depth shall be recorded with a stadia rod, and when that average depth across the isolator row reached 3-inches, the system shall be cleaned out.

Cleaning is performed through the Jet-vac process whereby the isolator chambers are washed with a high-pressure water system and the captured pollutants are then vacuumed out.

Refer to the attached Stormtech Operations and Maintenance document for additional information.

4.5 Stormtech Isolator Row

Stormtech Isolator Rows shall be inspected every three months for the first year, then timed thereafter based upon the depth of sediment build up witnessed in the previous inspections. Inspection ports shall be located strategically throughout the isolator row system. When sediment is observed, the depth shall be recorded with a stadia rod, and when that average depth across the chambers reaches 3-inches, the system shall be cleaned out.

Cleaning is performed through the Jet-vac process whereby the chambers are washed with a high-pressure water system and the captured pollutants are then vacuumed out.

Refer to the attached Stormtech Isolator Row Operations and Maintenance document for additional information.

4.6 Outlet Control Structure

Inspect and/or clean outlet control structures at least four times per year and at the end of foliage and snow removal seasons. Sediments must be removed whenever the depth of deposits is greater than or equal to one half the depth from the bottom of the invert of the lowest pipe in the structure. The structures should be cleaned a minimum of four times per year regardless of the amount of sediment in the basin. Outlet control structures shall be cleaned with clamshell buckets or by hand tools where necessary.

In the event of contamination by a spill or other means, all cleanings must be evaluated in accordance with the Hazardous Waste Regulations, 310 CMR 30.000 and handled as hazardous waste.

In the absence of evidence of contamination, cleanings may be taken to a landfill or other facility permitted by MassDEP to accept Solid Waste without any prior approval by MassDEP. Please note that current MassDEP regulations prevent landfills from accepting materials that contain free-draining liquids.

4.7 Deep Sump Catch Basins

Inspect and/or clean catch basin at least four times per year and at the end of foliage and snow removal seasons. Sediments must be removed whenever the depth of deposits is greater than or equal to one half the depth from the bottom of the invert of the lowest pipe in the basin. The catch basin should be cleaned a minimum of four times per year

regardless of the amount of sediment in the basin. Catch basins shall be cleaned with clamshell buckets.

In the event of contamination by a spill or other means, all cleanings must be evaluated in accordance with the Hazardous Waste Regulations, 310 CMR 30.000 and handled as hazardous waste.

In the absence of evidence of contamination, catch basin cleanings may be taken to a landfill or other facility permitted by MassDEP to accept Solid Waste without any prior approval by MassDEP. Please note that current MassDEP regulations prevent landfills from accepting materials that contain free-draining liquids.

4.8 Inspections and Record Keeping

- An inspection form should be filled out each and every time maintenance work is performed.
- A binder should be kept at the facility that contains all of the completed inspection forms and any other related materials.
- A review of all Operation & Maintenance actions should take place annually to ensure that these Stormwater BMPs are being taken care of in the manner illustrated in this Operation & Maintenance Plan.
- All operation and maintenance log forms for the last three years, at a minimum, shall be kept on site at the facility.
- The inspection and maintenance schedule may be refined in the future based on the findings and results of this operation and maintenance program or policy.

5.0 **Public Safety Features**

The only stormwater basins on site have been designed to be very shallow in depth, thereby not presenting any harm to the public.

6.0 **Stormwater Management System Owner/Responsible Party**

The stormwater management system shall be owned and maintained by the following party or its future designee/assigns:

City of Boston
Department of Public Works
Chris Osgood, Chief of the Streets, Transportation, and Sanitation
1 City Hall Square, Room 603
Boston, MA 02201

This operation and Maintenance Plan will be recorded with the registry of deeds so that current and future owners are aware of the requirement for proper operation and maintenance of the onsite stormwater system.

7.0 General Good Housekeeping Practices

All non-hazardous waste shall be stored in designated trash or recycling containers onsite for periodic collection by the local trash collector. The Boston Department of Public Works shall have maintenance staff who monitor the site for the accumulation of trash. Any trash that is seen onsite shall immediately be collected and placed into designated trash or recycling containers. The Boston Department of Public Works maintenance staff shall make an inspection of the site once per week at minimum.

8.0 Estimated Operations and Maintenance Budget

The estimated budget for annual operations and maintenance of this stormwater system is \$2,000 per year.

McConnell Park
Permanent BMP Inspection Checklist

Grassed Areas

Frequency: Grassed areas acting as vegetated filter strips should be inspected every six months during the first year and annually thereafter.

Location: _____

Inspected By: _____ Date: _____

Observations: _____

Actions Taken: _____

Instructions: Inspect grassed area. Mow grass as needed. Remove accumulated trash and debris. Remove sediment and re-seed bare spots as needed. All trash, debris, and sediments should be disposed of in accordance with local, state, and federal regulations.

Pea Stone Diaphragms

Frequency: Twice per year, primarily in the spring and fall.

Inspected By: _____ Date: _____

Observations: _____

Actions Taken: _____

Instructions: Remove all trash and debris. Replace missing stone as necessary. Once per year, remove accumulated sediments from the trench. All trash, debris, and sediments should be disposed of in accordance with local, state, and federal regulations.

Bio-Retention Areas

Frequency: The bio-retention areas should be inspected monthly.

Inspected By: _____ Date: _____

Observations: _____

Actions Taken: _____

Instructions: Inspect grassed area. Mow grass as needed on basin side slopes and embankment. Remove accumulated trash and debris. Remove sediment and re-mulch bare spots as needed in basin bottom. Inspect pipe inlets/outfalls for damage, erosion or blockage, remove blockage as needed, repair erosion with riprap. Inspect embankments, spillways and swales for erosion or blockage. Repair erosion with riprap, remove blockage as needed. Check sediment accumulation in forebays and remove as necessary. All trash, debris, and sediments should be disposed of in accordance with local, state, and federal regulations.



Subsurface Infiltration Structures and Isolator Row

Frequency: The Subsurface Infiltration Structures and Isolator row should be inspected every six months during the first year and annually thereafter.

Structure No.: _____

Inspected By: _____ Date: _____

Observations: _____

Actions Taken: _____

Instructions: Inspect grassed area. Mow grass as needed in infiltration basins. Remove accumulated trash and debris. Remove sediment and re-seed bare spots as needed. All trash, debris, and sediments should be disposed of in accordance with local, state, and federal regulations. Inspect underground isolation rows of chambers via manholes or inspection ports. Use reverse water jet to pull sediment back into manhole. Remove sediment, trash and debris as noted above.

Outlet Control Structure

Frequency: Inspect and clean deep sump catch basins and outlet control structures in March, June, September and December.

Structure Number: _____

Inspected By: _____ Date: _____

Observations: _____

Actions Taken: _____

Instructions: Clean units four times per year or whenever the depth of the deposits is greater than or equal to one half the depth from the bottom of the invert to the lowest pipe in the structure. Remove all trash and debris as necessary.

Deep Sump Catch Basins

Frequency: Inspect and clean deep sump catch basins in March, June, September and December.

Structure Number: _____

Inspected By: _____ Date: _____

Observations: _____

Actions Taken: _____

Instructions: Clean units four times per year or whenever the depth of the deposits is greater than or equal to one half the depth from the bottom of the invert to the lowest pipe in the structure.

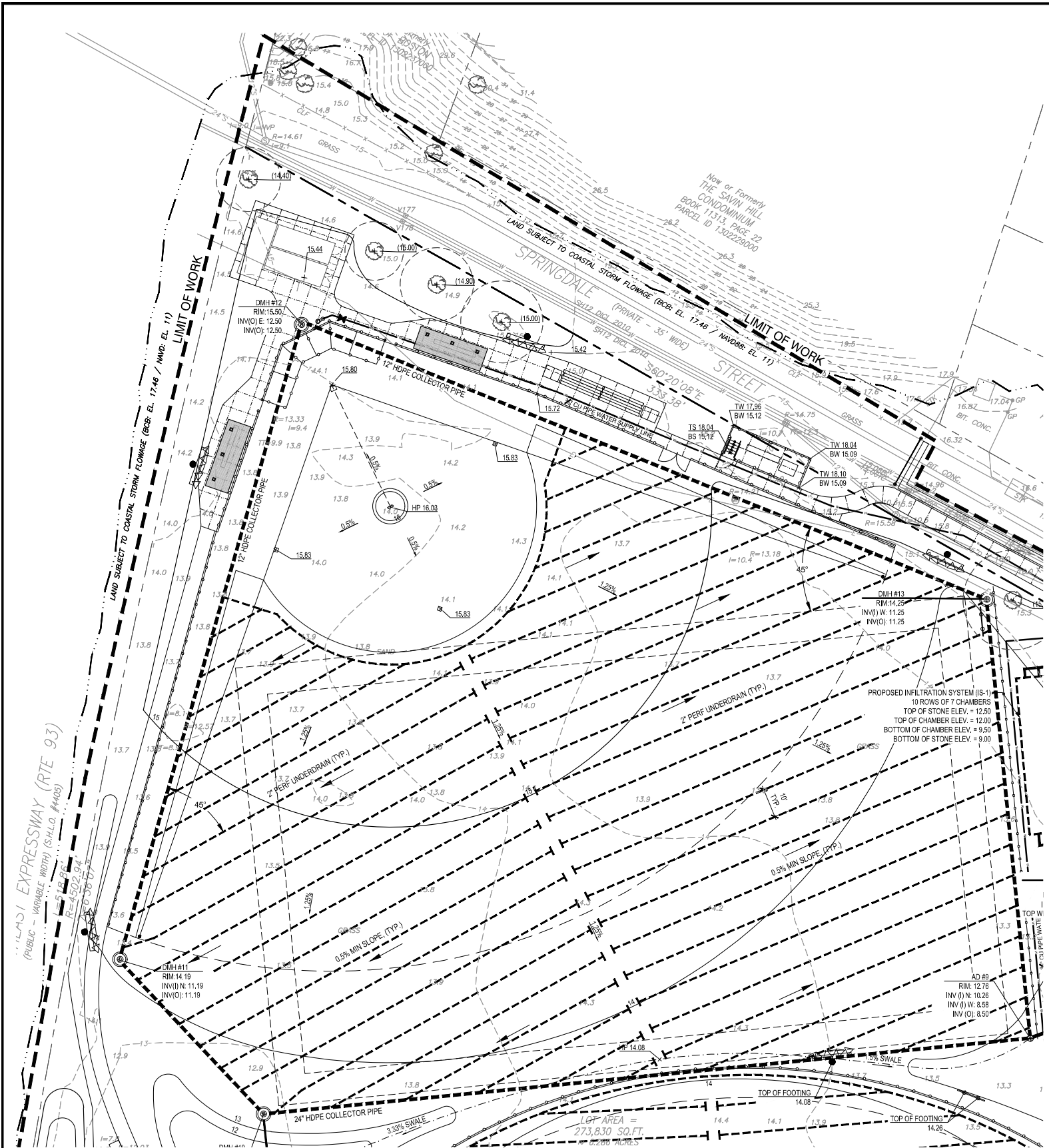

1 MULTI-USE FIELD ENLARGEMENT PLAN
SCALE: 1" = 20'-0"

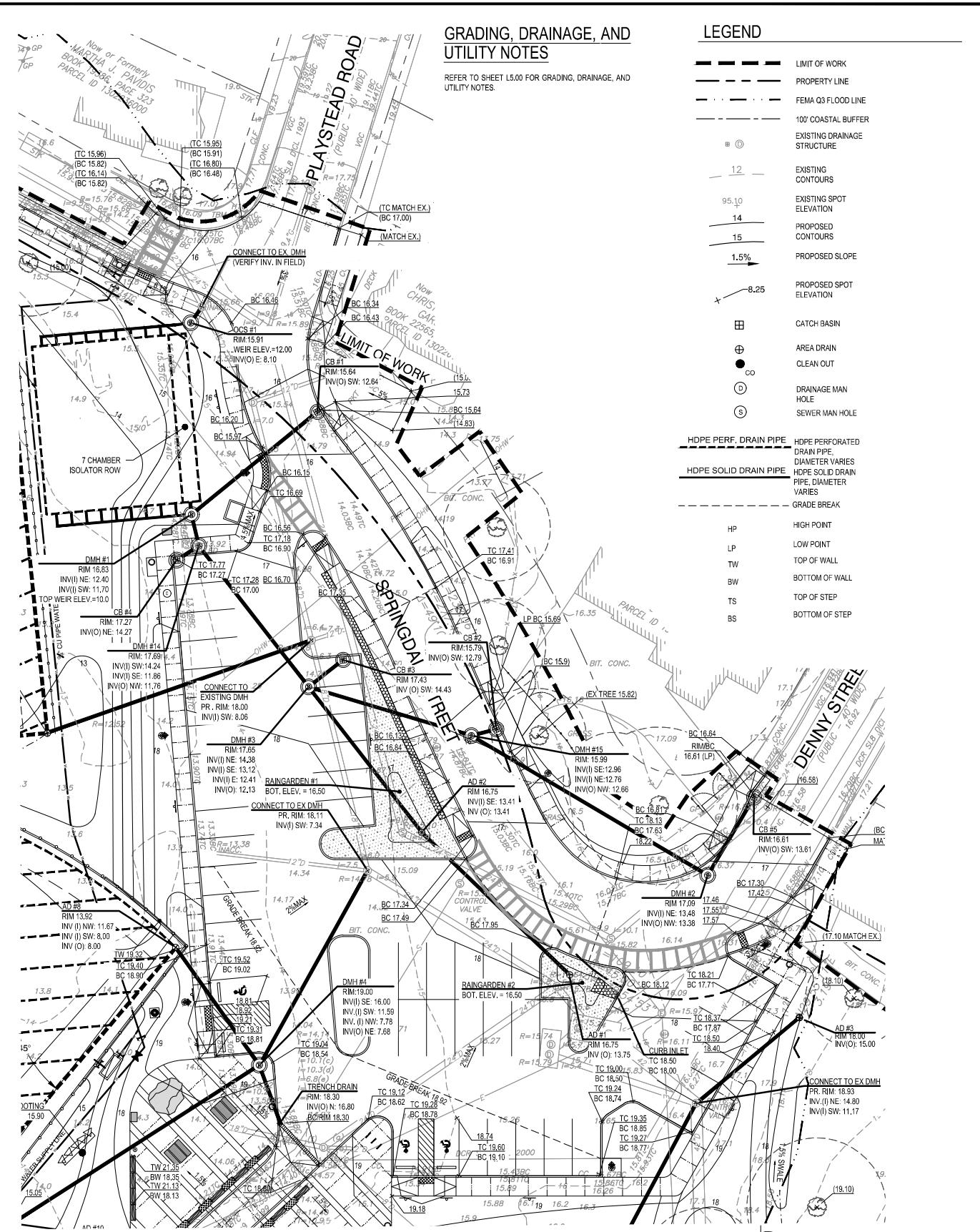

2 RIGHT-OF-WAY ENLARGEMENT PLAN
SCALE: 1" = 20'-0"

GRADING, DRAINAGE, AND UTILITY NOTES

REFER TO SHEET L5.00 FOR GRADING, DRAINAGE, AND UTILITY NOTES.

LEGEND

- LIMIT OF WORK
- - - PROPERTY LINE
- - - FEMA Q3 FLOOD LINE
- - - 100' COASTAL BUFFER
- EXISTING DRAINAGE STRUCTURE
- EXISTING CONTOURS
- EXISTING SPOT ELEVATION
- PROPOSED CONTOURS
- PROPOSED SLOPE
- PROPOSED SPOT ELEVATION
- CATCH BASIN
- AREA DRAIN
- CLEAN OUT
- DRAINAGE MAN HOLE
- SEWER MAN HOLE
- HDPE PERF. DRAIN PIPE
- HDPE SOLID DRAIN PIPE
- GRADE BREAK
- HP HIGH POINT
- LP LOW POINT
- TW TOP OF WALL
- BS BOTTOM OF WALL
- TS TOP OF STEP
- BS BOTTOM OF STEP



Prepared By:
Weston & Sampson



No.	Date	Revision

Project Name:
IMPROVEMENTS TO McCONNELL PARK

NOTICE OF INTENT - NOT FOR CONSTRUCTION -
Date: OCTOBER 2020
Scale: 1" = 20'-0"
Drawn: ENB, LSR
Checked: CFR

Sheet Name:
O&M KEY PLAN

SHEET:
FIG-3

Consultant Project No. 2160850

Approved By: _____ Date: _____

Isolator[®] Row O&M Manual



THE ISOLATOR[®] ROW

INTRODUCTION

An important component of any Stormwater Pollution Prevention Plan is inspection and maintenance. The StormTech Isolator Row is a technique to inexpensively enhance Total Suspended Solids (TSS) removal and provide easy access for inspection and maintenance.

THE ISOLATOR ROW

The Isolator Row is a row of StormTech chambers, either SC-160LP, SC-310, SC-310-3, SC-740, DC-780, MC-3500 or MC-4500 models, that is surrounded with filter fabric and connected to a closely located manhole for easy access. The fabric-wrapped chambers provide for settling and filtration of sediment as storm water rises in the Isolator Row and ultimately passes through the filter fabric. The open bottom chambers and perforated sidewalls (SC-310, SC-310-3 and SC-740 models) allow storm water to flow both vertically and horizontally out of the chambers. Sediments are captured in the Isolator Row protecting the storage areas of the adjacent stone and chambers from sediment accumulation.

Two different fabrics are used for the Isolator Row. A woven geotextile fabric is placed between the stone and the Isolator Row chambers. The tough geotextile provides a media for storm water filtration and provides a durable surface for maintenance operations. It is also designed to prevent scour of the underlying stone and remain intact during high pressure jetting. A non-woven fabric is placed over the chambers to provide a filter media for flows passing through the perforations in the sidewall of the chamber. The non-woven fabric is not required over the SC-160LP, DC-780, MC-3500 or MC-4500 models as these chambers do not have perforated side walls.

The Isolator Row is typically designed to capture the “first flush” and offers the versatility to be sized on a volume basis or flow rate basis. An upstream manhole not only provides access to the Isolator Row but typically includes a high flow weir such that storm water flowrates or volumes that exceed the capacity of the Isolator Row overtop the overflow weir and discharge through a manifold to the other chambers.

The Isolator Row may also be part of a treatment train. By treating storm water prior to entry into the chamber system, the service life can be extended and pollutants such as hydrocarbons can be captured. Pre-treatment best management practices can be as simple as deep sump catch basins, oil-water separators or can be innovative storm water treatment devices. The design of the treatment train and selection of pretreatment devices by the design engineer is often driven by regulatory requirements. Whether pretreatment is used or not, the Isolator Row is recommended by StormTech as an effective means to minimize maintenance requirements and maintenance costs.

Note: See the StormTech Design Manual for detailed information on designing inlets for a StormTech system, including the Isolator Row.



Looking down the Isolator Row from the manhole opening, woven geotextile is shown between the chamber and stone base.



StormTech Isolator Row with Overflow Spillway (not to scale)

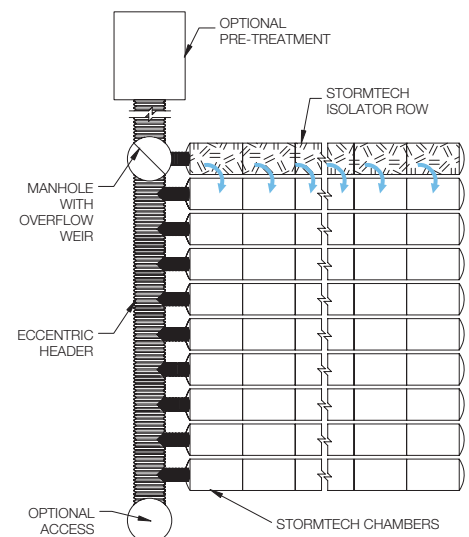



ISOLATOR ROW INSPECTION/MAINTENANCE

INSPECTION

The frequency of inspection and maintenance varies by location. A routine inspection schedule needs to be established for each individual location based upon site specific variables. The type of land use (i.e. industrial, commercial, residential), anticipated pollutant load, percent imperviousness, climate, etc. all play a critical role in determining the actual frequency of inspection and maintenance practices.

At a minimum, StormTech recommends annual inspections. Initially, the Isolator Row should be inspected every 6 months for the first year of operation. For subsequent years, the inspection should be adjusted based upon previous observation of sediment deposition.

The Isolator Row incorporates a combination of standard manhole(s) and strategically located inspection ports (as needed). The inspection ports allow for easy access to the system from the surface, eliminating the need to perform a confined space entry for inspection purposes.

If upon visual inspection it is found that sediment has accumulated, a stadia rod should be inserted to determine the depth of sediment. When the average depth of sediment exceeds 3 inches throughout the length of the Isolator Row, clean-out should be performed.

MAINTENANCE

The Isolator Row was designed to reduce the cost of periodic maintenance. By “isolating” sediments to just one row, costs are dramatically reduced by eliminating the need to clean out each row of the entire storage bed. If inspection indicates the potential need for maintenance, access is provided via a manhole(s) located on the end(s) of the row for cleanout. If entry into the manhole is required, please follow local and OSHA rules for a confined space entries.

Maintenance is accomplished with the JetVac process. The JetVac process utilizes a high pressure water nozzle to propel itself down the Isolator Row while scouring and suspending sediments. As the nozzle is retrieved, the captured pollutants are flushed back into the manhole for vacuuming. Most sewer and pipe maintenance companies have vacuum/JetVac combination vehicles. Selection of an appropriate JetVac nozzle will improve maintenance efficiency. Fixed nozzles designed for culverts or large diameter pipe cleaning are preferable. Rear facing jets with an effective spread of at least 45” are best. Most JetVac reels have 400 feet of hose allowing maintenance of an Isolator Row up to 50 chambers long. **The JetVac process shall only be performed on StormTech Isolator Rows that have AASHTO class 1 woven geotextile (as specified by StormTech) over their angular base stone.**

StormTech Isolator Row (not to scale)

Note: Non-woven fabric is only required over the inlet pipe connection into the end cap for SC-160LP, DC-780, MC-3500 and MC-4500 chamber models and is not required over the entire Isolator Row.

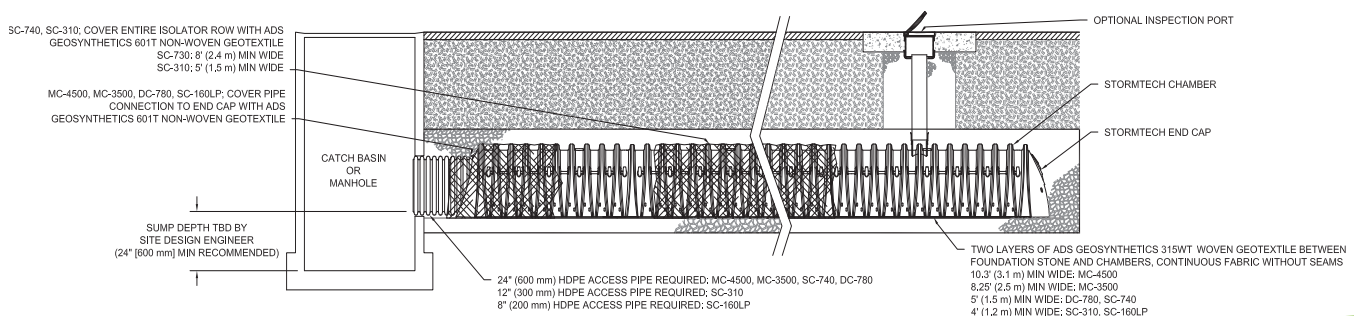

ISOLATOR ROW STEP BY STEP MAINTENANCE PROCEDURES

STEP 1

Inspect Isolator Row for sediment.

- A) Inspection ports (if present)
 - i. Remove lid from floor box frame
 - ii. Remove cap from inspection riser
 - iii. Using a flashlight and stadia rod, measure depth of sediment and record results on maintenance log.
 - iv. If sediment is at or above 3 inch depth, proceed to Step 2. If not, proceed to Step 3.
- B) All Isolator Rows
 - i. Remove cover from manhole at upstream end of Isolator Row
 - ii. Using a flashlight, inspect down Isolator Row through outlet pipe
 - 1. Mirrors on poles or cameras may be used to avoid a confined space entry
 - 2. Follow OSHA regulations for confined space entry if entering manhole
 - iii. If sediment is at or above the lower row of sidewall holes (approximately 3 inches), proceed to Step 2. If not, proceed to Step 3.

STEP 2

Clean out Isolator Row using the JetVac process.

- A) A fixed floor cleaning nozzle with rear facing nozzle spread of 45 inches or more is preferable
- B) Apply multiple passes of JetVac until backflush water is clean
- C) Vacuum manhole sump as required

STEP 3

Replace all caps, lids and covers, record observations and actions.

STEP 4

Inspect & clean catch basins and manholes upstream of the StormTech system.

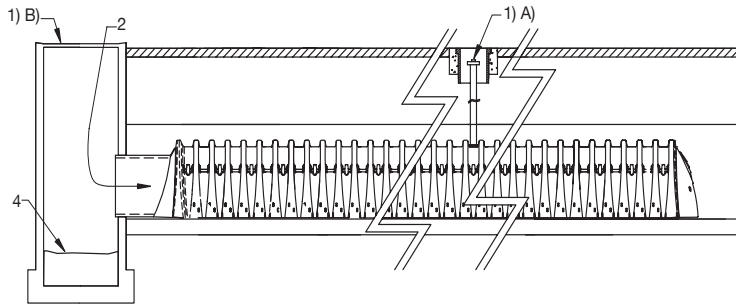

SAMPLE MAINTENANCE LOG

Date	Stadia Rod Readings		Sediment Depth (1)-(2)	Observations/Actions	Inspector
	Fixed point to chamber bottom (1)	Fixed point to top of sediment (2)			
3/15/11	6.3 ft	none		New installation. Fixed point is CI frame at grade	DJM
9/24/11		6.2	0.1 ft	Some grit felt	SM
6/20/13		5.8	0.5 ft	Mucky feel, debris visible in manhole and in Isolator Row, maintenance due	NV
7/7/13	6.3 ft		0	System jetted and vacuumed	DJM

Attachment I - Illicit Discharge Compliance Statement

Illicit Discharge Compliance Statement

Section I – Purpose/Intent

The purpose of this document is to provide for the health, safety, and general welfare of the citizens of Boston, Massachusetts through the regulation of non-stormwater discharges into existing outstanding resource areas near the site to the maximum extent practicable, as required by federal and state law. This document establishes methods for controlling the introduction of pollutants into existing outstanding resource areas to comply with requirements of the National Pollutant Discharge Elimination System (NPDES) permit process.

Section II - Definitions

For the purposes of this statement, the following shall apply:

Best Management Practices (BMPs): Schedules of activities, prohibitions of practices, general good housekeeping practices, pollution prevention and educational practices, maintenance procedures, and other management practices to prevent or reduce the discharge of pollutants directly or indirectly to stormwater, receiving waters, or stormwater conveyance systems. BMPs also include treatment practices, operating procedures, and practices to control site runoff, spillage or leaks, sludge or water disposal, or drainage from raw materials storage.

Clean Water Act: The federal Water Pollution Control Act (33 U.S.C § 1251 et seq.), and any subsequent amendments thereto.

Construction Activity: Activities subject to the Massachusetts Erosion and Sedimentation Control Act or NPDES Construction Permits. Such activities include but are not limited to clearing and grubbing, grading, excavating, and demolition.

Hazardous Materials: Any material, including any substance, waste, or combination thereof, which because of its quantity, concentration, or physical, chemical, or infectious characteristics may cause, or significantly contribute to, a substantial present or potential hazard to human health, safety, property, or the environment when improperly treated, stored, transported, disposed of, or otherwise managed.

Illegal Connection: An illegal connection is defined as either of the following:

- a. Any pipe, open channel, drain or conveyance, whether on the surface or subsurface, which allows an illicit discharge to enter the outstanding resource area including but not limited to any conveyances which allow any non-stormwater discharge including sewage, process wastewater, and wash water, regardless of whether said drain or connection has been previously allowed, permitted, or approved by an authorized enforcement agency; or
- b. Any pipe, open channel, drain or conveyance connected to the City of Boston storm water treatment system which has not been documented in plans, maps, or equivalent records and approved by an authorized enforcement agency.

Illicit Discharge: Any direct or indirect non-stormwater discharge to the City of Boston stormwater treatment system, except as exempted in Section II of this ordinance.

Industrial Activity: Activities subject to NPDES Industrial Permits as defined in 40CFR, Section 122.26 (b) (14).

National Pollutant Discharge Elimination System (NPDES) Stormwater Discharge Permit: A permit issued by MassDEP under authority delegated pursuant to 33 USC § 1342 (b) that authorizes the discharge of pollutants to waters of the United States, whether the permit is applicable on an individual, group, or general area-wide basis.

City of Boston Stormwater Treatment System: Any facility, owned or maintained by the City, designed or used for collecting and/or conveying stormwater, including but not limited to roads with drainage systems, City of Boston streets, curbs, gutters, inlets, catch basins, piped storm drains, pumping facilities, infiltration, retention and detention basins, natural and man-made or altered drainage channels, reservoirs, and other drainage structures.

Non-Stormwater Discharge: Any discharge to the storm drain system that is not composed entirely of stormwater.

Person: Any individual, association, organization, partnership, firm, joint venture, public or private corporation, trust, estate, commission, board, public or private institution, utility, cooperative, city, county or other political subdivision of the State, interstate body, or any other legal entity.

Pollutant: Anything which causes or contributes to pollution. Pollutants may include, but are not limited to: paints, varnishes, and solvents; petroleum hydrocarbons; automotive fluids; cooking grease; detergents (biodegradable or otherwise); degreasers; cleaning chemicals; non-hazardous liquid and solid wastes; refuse, rubbish, garbage, litter, or other discarded or abandoned objects and accumulations, so that same may cause or contribute to pollution; floatables; pesticides, herbicides, and fertilizers; liquid and solid wastes; sewage, fecal coliform and pathogens; dissolved and particulate metals; animal wastes; wastes and residues that result from constructing a building or structure; concrete and cement; and noxious or offensive matter of any kind.

Pollution: Contamination or other alteration of any water's physical, chemical, or biological properties by addition of any constituent including but not limited to a change in temperature, taste, color, turbidity, or odor of such waters, or the discharge of any liquid, gaseous, solid, radioactive, or other substance into any such waters as will or is likely to create a nuisance or render such waters harmful, detrimental, or injurious to the public health, safety, welfare, or environment, or to domestic, commercial, industrial, agricultural, recreational, or other legitimate beneficial uses, or to livestock, wild animals, birds, fish or other aquatic life.

Premises: Any building, lot, parcel of land, or portion of land whether improved or unimproved including adjacent sidewalks and parking strips.

Stormwater: Any surface flow, runoff, and drainage consisting entirely of water from any form of natural precipitation, and resulting from such precipitation.

Wastewater: Any water or other liquid discharged from a facility, that has been used, as for washing, flushing, or in a manufacturing process, and so contains waste products.

Section III - Prohibitions

Prohibition of Illicit Discharges:

No person shall throw, drain, or otherwise discharge, cause or allow others under its control to throw, drain, or otherwise discharge into the City of Boston stormwater treatment system or watercourses any materials, including but not limited to, any pollutants or waters containing any pollutants, other than stormwater. The commencement, conduct, or continuance of any illicit discharge to the storm drain system is prohibited except as described as follows:

1. Water line flushing performed by a government agency, other potable water sources, landscape irrigation or lawn watering, diverted stream flows, rising ground water, ground water infiltration to storm drains, uncontaminated pumped ground water, foundation or footing drains (not including active groundwater dewatering systems), crawl space pumps, air conditioning condensation, springs, natural riparian habitat or wetland flows, and any other water source not containing pollutants;
2. Discharges or flows from fire fighting, and other discharges specified in writing by the City of Boston as being necessary to protect public health and safety;
3. Dye testing is an allowable discharge, but requires a verbal notification to the City of Boston prior to the time of the test;
4. Any non-stormwater discharge permitted under an NPDES permit, waiver, or waste discharge order issued to the discharger and administered under the authority of the Federal Environmental Protection Agency, provided that the discharger is in full compliance with all requirements of the permit, waiver, or order and other applicable laws and regulations, and provided that written approval has been granted for a discharge to the City of Boston stormwater treatment system.

Section IV - Industrial or Construction Activity Discharges

Any person subject to an industrial or construction activity NPDES stormwater discharge permit shall comply with all provisions of such permit. Proof of compliance with said permit may be required in a form acceptable to the City of Boston Department of Public Works prior to allowing discharges to the Boston stormwater treatment system.

Section V - Notification of Spills and Accidental Discharges

Notwithstanding other requirements of law, as soon as any person responsible for a facility, activity or operation, or responsible for emergency response for a facility, activity or operation has information of any known or suspected release of pollutants or non-stormwater discharges from that facility, activity, or operation which are resulting or may result in illicit discharges or pollutants discharging into stormwater, the City of Boston stormwater treatment system, State Waters, or Waters of the U.S., said person shall take all necessary steps to ensure the discovery, containment, and cleanup of such release so as to minimize the effects of the discharge. In the event of such a release of hazardous materials, said person shall immediately notify emergency

response agencies of the occurrence via emergency dispatch services. In the event of a release of non-hazardous materials, said person shall notify the City of Boston Public Services Department in person or by phone no later than the next business day, including the nature, quantity and time of occurrence of the discharge. Notifications in person or by phone shall be confirmed by written notice, via certified mail return receipt requested addressed to the City of Boston Public Services Department within three (3) business days of the initial notice. If the discharge of prohibited materials emanates from a commercial or industrial establishment, the owner or operator of such establishment shall also retain an on-site written record of the discharge and the actions taken to prevent its recurrence. Such records shall be retained for at least three years.

IN WITNESS WHEREOF the parties hereto have executed copies of this Agreement on the 26
day of January, 2021.

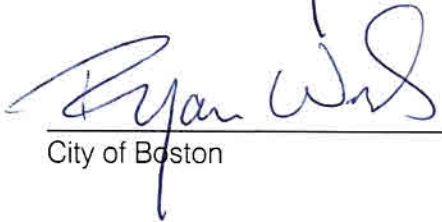

City of Boston

Appendix C



Legend

 Work Area

FIGURE 1

McCConnell Playground
Boston, MA

Locus Map

Copyright © 2013 National Geographic Society, i-cubed

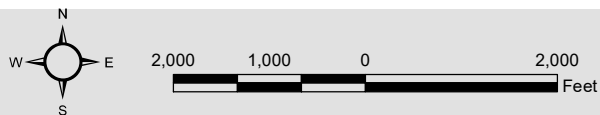

Data Source: Office of Geographic and Environmental Information (MassGIS),
Commonwealth of Massachusetts Executive Office of Environmental Affairs



Source: Esri, DigitalGlobe, GeoEye, Earthstar Geographics, CNES/Airbus DS, USDA, USGS, AeroGRID, IGN, and the GIS User Community

Legend

- Work Area
- ACECs**
- ACECs
- NHESP Habitats**
- NHESP Estimated Habitats of Rare Wildlife
- NHESP Priority Habitats of Rare Species
- * NHESP Certified Vernal Pools
- * NHESP Potential Vernal Pools
- Perennial Stream
- - - Intermittent Stream
- Hydrologic Connection
- DEP Wetlands**
- Marsh/Bog
- Wooded marsh
- Cranberry Bog
- Salt Marsh
- Open Water
- Reservoir (with PWSID)
- Tidal Flats
- Beach/Dune

FIGURE 2
McCormell Playground
Boston, MA

Environmental
Resource Map



National Flood Hazard Layer FIRMette



42°18'42.78"N

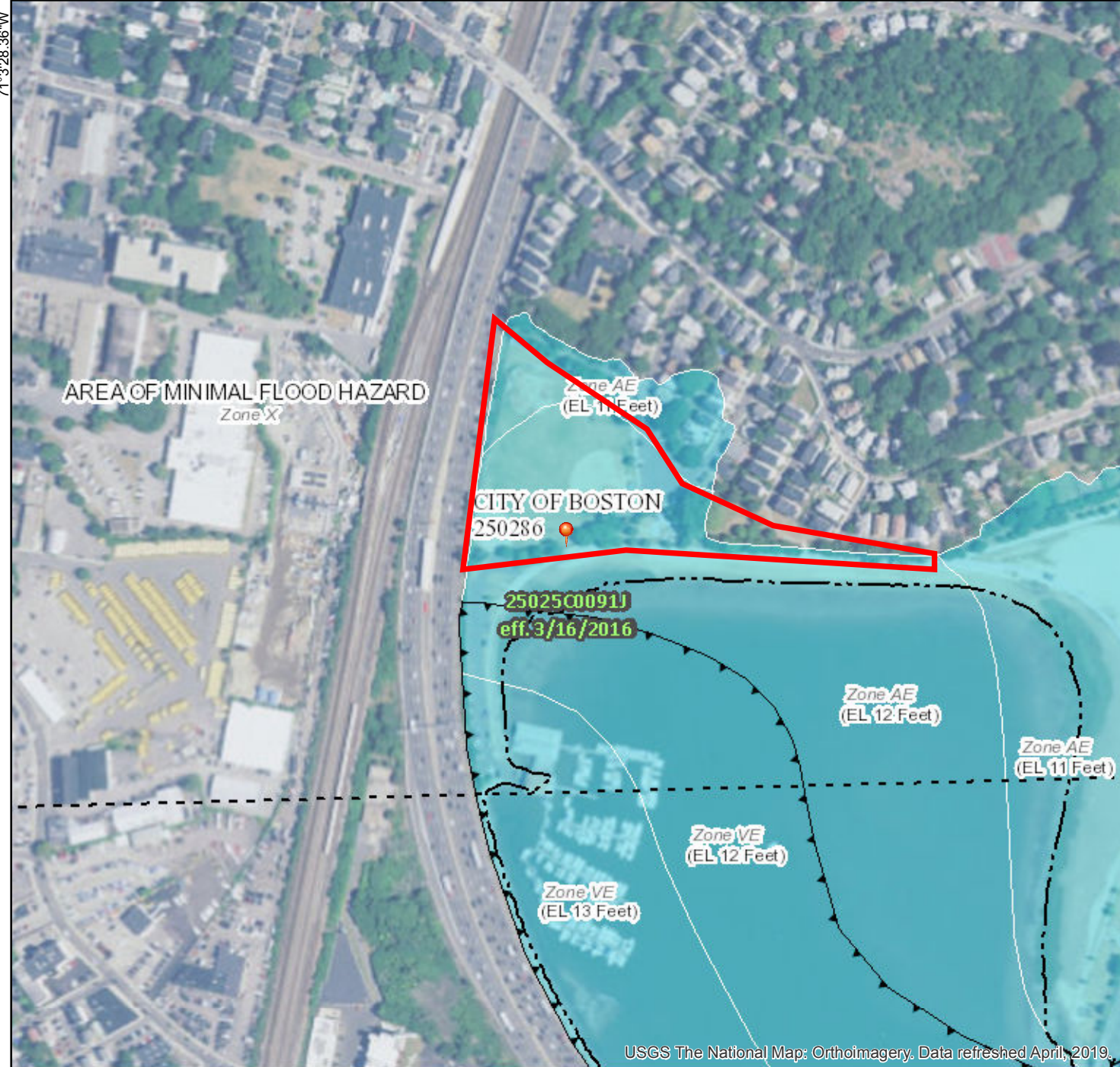

Legend

SEE FIS REPORT FOR DETAILED LEGEND AND INDEX MAP FOR FIRM PANEL LAYOUT

- | | | |
|------------------------------------|--|--|
| SPECIAL FLOOD HAZARD AREAS | | Without Base Flood Elevation (BFE)
<i>Zone A, V, A99</i> |
| | | With BFE or Depth <i>Zone AE, AO, AH, VE, AR</i> |
| | | Regulatory Floodway |
| OTHER AREAS OF FLOOD HAZARD | | 0.2% Annual Chance Flood Hazard, Areas of 1% annual chance flood with average depth less than one foot or with drainage areas of less than one square mile <i>Zone X</i> |
| | | Future Conditions 1% Annual Chance Flood Hazard <i>Zone X</i> |
| | | Area with Reduced Flood Risk due to Levee. See Notes. <i>Zone X</i> |
| | | Area with Flood Risk due to Levee <i>Zone D</i> |
| OTHER AREAS | | NO SCREEN Area of Minimal Flood Hazard <i>Zone X</i> |
| | | Effective LOMRs |
| | | Area of Undetermined Flood Hazard <i>Zone D</i> |
| GENERAL STRUCTURES | | Channel, Culvert, or Storm Sewer |
| | | Levee, Dike, or Floodwall |
| OTHER FEATURES | | 20.2 Cross Sections with 1% Annual Chance Water Surface Elevation |
| | | 17.5 Cross Sections with 1% Annual Chance Water Surface Elevation |
| | | Coastal Transect |
| | | Base Flood Elevation Line (BFE) |
| | | Limit of Study |
| | | Jurisdiction Boundary |
| | | Coastal Transect Baseline |
| | | Profile Baseline |
| | | Hydrographic Feature |
| MAP PANELS | | Digital Data Available |
| | | No Digital Data Available |
| | | Unmapped |
| | | The pin displayed on the map is an approximate point selected by the user and does not represent an authoritative property location. |



This map complies with FEMA's standards for the use of digital flood maps if it is not void as described below. The basemap shown complies with FEMA's basemap accuracy standards

The flood hazard information is derived directly from the authoritative NFHL web services provided by FEMA. This map was exported on 7/5/2019 at 12:44:17 PM and does not reflect changes or amendments subsequent to this date and time. The NFHL and effective information may change or become superseded by new data over time.

This map image is void if the one or more of the following map elements do not appear: basemap imagery, flood zone labels, legend, scale bar, map creation date, community identifiers, FIRM panel number, and FIRM effective date. Map images for unmapped and unmodernized areas cannot be used for regulatory purposes.

0 250 500 1,000 1,500 2,000 Feet 1:6,000

USGS The National Map: Orthoimagery. Data refreshed April, 2019.

42°18'16.17"N

71°3'28.36"W

Appendix D

SECTION 01562

DUST CONTROL

PART 1 - GENERAL

1.01 DESCRIPTION:

This section of the specification covers the control of dust via water, complete.

PART 2 - PRODUCTS

2.01 WATER:

- A. Water shall not be brackish and shall be free from oil, acid, and injurious alkali or vegetable matter.

PART 3 - EXECUTION

3.01 APPLICATION:

- A. Water may be sprinkler applied with equipment including a tank with gauge-equipped pressure pump and a nozzle-equipped spray bar.
- B. Water shall be dispersed through the nozzle under a minimum pressure of 20 pounds per square inch, gauge pressure.

END OF SECTION

\\wse03.local\WSE\Projects\MA\Boston MA\McConnell Playground\Permitting\NOI playground construction\Appendix D Specs\SECTION 01562-Dust Control.docx

SECTION 01570

ENVIRONMENTAL PROTECTION

PART 1 – GENERAL

1.01 DESCRIPTION:

- A. The work covered by this section of the specifications consists of furnishing all labor, materials, tools and equipment and performing all work required for the prevention of environmental pollution during and as a result of construction operations under this contract.
- B. The requirements set forth in this section of the specifications apply to construction in and adjacent to wetlands, unless otherwise specifically stated.
- C. All work under this Contract shall be in accordance with the Conservation Commissions' Orders of Conditions as well as any conditional requirements applied
- D. Prior to commencement of work, the Contractor shall meet with representatives of the Engineer to develop mutual understandings relative to compliance of the environmental protection program.

1.02 SUBMITTALS:

- A. The Contractor shall submit for approval six sets of details and literature fully describing environmental protection methods to be employed in carrying out construction activities within 100 feet of wetlands or across areas designated as wetlands.

PART 2 - PRODUCTS

2.01 SILT FENCE:

- A. The silt fence shall consist of a 3-foot wide continuous length sediment control fabric, stitched to a mesh backing, and stapled to preweathered oak posts installed as shown on the drawings. The oak posts shall be 1-1/4-inches by 1-1/4-inches (Minimum Dimension) by 48-inches and shall be tapered. The bottom edge of the silt fence shall be buried as shown on the drawings.
- B. The silt fence shall be DOT Silt Fence PPDM3611, as manufactured by U.S. Silt & Site Supply/Getsco, Concord, NH, or approved equal.
- C. Silt fence properties:

<u>Physical Properties</u>	<u>Test Method</u>	<u>Minimum Value</u>
Grab Strength, lbs.	ASTM-D-4632	124
Grab Elongation, %	ASTM-D-4632	15
Mullen burst, psi	ASTM-D-3786	300

Puncture, lbs.	ASTM-D-4833	65
Trapezoidal Tear, lbs.	ASTM-D-4833	65
UV Resistance ² , % ³	ASTM-D-4355	80@500 hrs.
AOS, US Sieve No.	ASTM-D-4751	30
Flow Rate, gal/min/sq ft	ASTM-D-4491	10
Permittivity, (1/sec) gal/min/sq ft	ASTM-D-4491	0.05 sec ⁻¹

2.02 STRAW BALES:

- A. Straw bales shall consist of certified seed free stems of agricultural grain and cereal crops and shall be free of grasses and legumes. Standard bales shall be 14-inches high, 18- inches wide and 36- to 40-inches long tied with polypropylene twine and weigh within 5 percent of 7 lbs. per cubic ft.

2.03 CATCH BASIN PROTECTION:

- A. To trap sediment and to prevent sediment from clogging drainage systems, catch basin protection in the form of a siltation sack (Silsack as manufactured by ACF Environmental, Inc. or approved equal) shall be provided as approved by the Engineer.

2.04 COMPOST FILTER TUBES:

- A. Silt socks shall be a tubular filter sock of mesh fabric. The fabric will have openings of between 1/8" to 1/4" diameter. The mesh material will either photo degrade within one year or be made of nylon with a life expectancy of 24 months. The sock shall be filled with a mix of composted leaf mulch, bark mulch and wood chips that have been composted for at least one year. The sock will have a minimum diameter of 12-inches.

PART 3- EXECUTION

3.01 NOTIFICATION AND STOPPAGE OF WORK:

- A. The Engineer will notify the Contractor in writing of any non-compliance with the provisions of the Order of Conditions. The Contractor shall, after receipt of such notice, immediately take corrective action. Such notice, when delivered to the Contractor or his authorized representative at the site of the work, shall be deemed sufficient for the purpose. If the Contractor fails to act promptly, the Owner may order stoppage of all or part of the work through the Engineer until satisfactory corrective action has been taken. No claim for an extension of time or for excess costs or damage incurred by the Contractor as a result of time lost due to any stop work orders shall be made unless it was later determined that the Contractor was in compliance.

3.02 AREA OF CONSTRUCTION ACTIVITY:

- A. Insofar as possible, the Contractor shall confine his construction activities to those areas defined by the plans and specifications. All land resources within the project boundaries and outside the limits of permanent work performed under this contract shall be preserved in their present condition or be restored to a condition after completion of

construction at least equal to that which existed prior to work under this contract.

3.03 PROTECTION OF WATER RESOURCES:

- A. The Contractor shall not pollute streams, lakes or reservoirs with fuels, oils, bitumens, calcium chloride, acids or other harmful materials. It is the Contractor's responsibility to comply with all applicable Federal, State, County and Municipal laws regarding pollution of rivers and streams.
- B. Special measures should be taken to insure against spillage of any pollutants into public waters.

3.04 PROTECTING AND MINIMIZING EXPOSED AREAS:

- A. The Contractor shall limit the area of land which is exposed and free from vegetation during construction. In areas where the period of exposure will be greater than two (2) months, temporary vegetation, mulching or other protective measures shall be provided as specified.
- B. The Contractor shall take account of the conditions of the soil where temporary cover crop will be used to insure that materials used for temporary vegetation are adaptive to the sediment control. Materials to be used for temporary vegetation shall be approved by the Engineer.

3.05 LOCATION OF STORAGE AREAS:

- A. The location of the Contractor's storage areas for equipment and/or materials shall be upon cleared portions of the job site or areas to be cleared as a part of this project, and shall require written approval of the Engineer. Plans showing storage facilities for equipment and materials shall be submitted for approval of the Engineer.
- B. No excavated materials or materials used in backfill operations shall be deposited within a minimum distance of one hundred (100) feet of any watercourse or any drainage facility. Adequate measures for erosion and sediment control such as the placement of baled straw or line of straw wattles or compost filter tubes around the downstream perimeter of stockpiles shall be employed to protect any downstream areas from siltation.
- C. There shall be no storage of equipment or materials in areas designated as wetlands.
- D. The Engineer may designate a particular area or areas where the Contractor may store materials used in his operations.

3.06 PROTECTION OF LANDSCAPE:

- A. The Contractor shall not deface, injure, or destroy trees or shrubs nor remove or cut them without written authority from the Owner. No ropes, cables, or guys shall be fastened to or attached to any existing nearby trees for anchorages unless specifically authorized by

the Engineer. Excavating machinery and cranes shall be of suitable type and be operated with care to prevent injury to trees which are not to be removed, particularly overhanging branches and limbs. The Contractor shall, in any event, be responsible for any damage resulting from such use.

- B. Branches, limbs, and roots shall not be cut except by permission of the Engineer. All cutting shall be smoothly and neatly done without splitting or crushing. When there is unavoidable injury to branches, limbs and trunks of trees, the injured portions shall be neatly trimmed and covered with an application of grafting wax or tree healing paint as directed.
- C. Where, in the opinion of the Engineer, trees may possibly be defaced, bruised, injured, or otherwise damaged by the Contractor's equipment or by his blasting or other operations, the Engineer may require the Contractor to adequately protect such trees by placing boards, planks, poles or fencing around them. Any trees or landscape feature scarred or damaged by the Contractor's equipment or operations shall be restored as nearly as possible to its original condition at the expense of the Contractor. The Engineer will decide what method of restoration shall be used, and whether damaged trees shall be treated and healed or removed and disposed of under the provisions of Section 02230, CLEARING AND GRUBBING.
- D. Cultivated hedges, shrubs, and plants which could be injured by the Contractor's operations shall be protected by suitable means or shall be dug up, balled and temporarily replanted and maintained. After construction operations have been substantially completed, they shall be replanted in their original positions and cared for until growth is re-established. If cultivated hedges, shrubs, and plants are injured to such a degree as to affect their growth or diminish their beauty or usefulness, they shall be replaced by items of a kind and quality at least equal to that existing at the start of the work.

3.07 CLEARING AND GRUBBING:

- A. The Contractor shall clear and grub only on the Owner's land or the Owner's easements, and only the area required for construction operations, as approved by the Engineer. Removal of mature trees (4 inches or greater DBH) will not be allowed on temporary easements.
- B. The Contractor shall not remove trees in the Owner's temporary easements without permission of the Engineer.

3.08 DISCHARGE OF DEWATERING OPERATIONS:

- A. Any water that is pumped and discharged from the excavation as part of the Contractor's water handling shall be filtered by an approved method prior to its discharge into a receiving water or drainage system.
- B. Under no circumstances shall the Contractor discharge water to the areas designated as wetlands. When constructing in a wetlands area, the Contractor shall discharge water from dewatering operations directly to the nearest drainage system, stream, or waterway

after filtering by an approved method.

- C. The pumped water shall be filtered through filter fabric and baled straw, a vegetative filter strip or a vegetated channel to trap sediment occurring as a result of the construction operations. The vegetated channel shall be constructed such that the discharge flow rate shall not exceed a velocity of more than 1 foot per second. Accumulated sediment shall be cleared from the channel periodically.

3.09 DUST CONTROL:

- A. During the progress of the work, the Contractor shall conduct his operations and maintain the area of his activities, including sweeping and sprinkling of streets as necessary, to minimize creation and dispersion of dust. If the Engineer decides it is necessary to use calcium chloride for more effective dust control, the Contractor shall furnish and spread the material, as directed. Calcium chloride shall be as specified under Section 01562, DUST CONTROL.
- B. Calcium Chloride shall not be used for dust control within a drainage basin or in the vicinity of any source of potable water.

3.10 BALED STRAW:

- A. To trap sediment and to prevent sediment from clogging drainage systems, baled straw shall be used where shown on the drawings. Care shall be taken to keep the bales from breaking apart. The bales should be securely staked to prevent overturning, flotation, or displacement. All deposited sediment shall be removed periodically. Straw bales shall not be placed within a waterway during construction of the pipeline crossing.

3.11 ERECTION AND MAINTENANCE OF SILT FENCE:

- A. Where indicated on the drawings or where required by the Engineer, the Contractor shall erect and maintain a temporary silt fence. In areas designated as wetlands, the Contractor shall line the limits of the construction easement with a silt fence. The silt fence shall be used specifically to contain sediment from runoff water and to minimize environmental damage caused by construction.

3.12 CATCH BASIN PROTECTION:

- A. Catch basin protection shall be used for every catch basin, shown on the plans or as required by the Engineer, to trap sediment and prevent it from clogging drainage systems and entering wetlands. Siltation sacks shall be securely installed under the catch basin grate. Care shall be taken to keep the siltation sacks from breaking apart or clogging. All deposited sediment shall be removed periodically and at times prior to predicted precipitation to allow free drainage flow. Prior to working in areas where catch basins are to be protected, each catch basin sump shall be cleaned of all debris and protected. The Contractor shall properly dispose of all debris at no additional cost to the Owner.

3.13 STRAW WATTLES:

- A. The wattles will be placed in a shallow trench (2-3 inches deep) and staked in the ground using wooden stakes driven at 4-foot intervals. The wooden stakes will be placed at a minimum depth of 24-inches into the ground.

3.14 COMPOST FILTER TUBES:

- A. The filter tubes will be staked in the ground using wooden stakes driven at 4-foot intervals. The wooden stakes will be placed at a minimum depth of 24-inches into the ground.

END OF SECTION

\\Wse03.local\WSE\Projects\MA\Boston MA\McConnell Playground\Permitting\NOI playground construction\Appendix D Specs\SECTION 01570 - Environmental Protection HIGGINS UPDATES.docx

SECTION 01740

CLEANING UP

PART 1 - GENERAL

1.01 DESCRIPTION:

The Contractor must employ at all times during the progress of its work adequate cleanup measures and safety precautions to prevent injuries to persons or damage to property. The Contractor shall immediately, upon request by the Engineer provide adequate material, equipment and labor to cleanup and make safe any and all areas deemed necessary by the Engineer.

PART 2 - PRODUCTS

Not applicable

PART 3 - EXECUTION

3.01 DAILY CLEANUP:

- A. The Contractor shall clean up, at least daily, all refuse, rubbish, scrap and surplus material, debris and unneeded construction equipment resulting from the construction operations and sweep the area. The site of the work and the adjacent areas affected thereby shall at all times present a neat, orderly and workmanlike appearance.
- B. Upon written notification by the Engineer, the Contractor shall within 24 hours clean up those areas, which in the Engineer's opinion are in violation of this section and the above referenced sections of the specifications.
- C. If in the opinion of the Engineer, the referenced areas are not satisfactorily cleaned up, all other work on the project shall stop until the cleanup is satisfactory.

3.02 MATERIAL OR DEBRIS IN DRAINAGE FACILITIES:

- A. Where material or debris has washed or flowed into or has been placed in existing watercourses, ditches, gutters, drains, pipes, structures, such material or debris shall be entirely removed and satisfactorily disposed of during progress of the work, and the ditches, channels, drains, pipes, structures, and work shall, upon completion of the work, be left in a clean and neat condition.

3.03 REMOVAL OF TEMPORARY BUILDINGS, STRUCTURES AND EQUIPMENT:

- A. On or before completion of the work, the Contractor shall, unless otherwise specifically required or permitted in writing, tear down and remove all temporary buildings and structures it built; shall remove all temporary works, tools and machinery or other construction

equipment it furnished; shall remove all rubbish from any grounds which it has occupied; shall remove silt fences and hay bales used for trapping sediment; and shall leave the roads and all parts of the property and adjacent property affected by its operations in a neat and satisfactory condition.

3.04 RESTORATION OF DAMAGED PROPERTY:

- A. The Contractor shall restore or replace, when and as required, any property damaged by its work, equipment or employees, to a condition at least equal to that existing immediately prior to the beginning of operations. To this end the Contractor shall do as required all necessary highway or driveway, walk and landscaping work. Materials, equipment, and methods for such restoration shall be as approved by the Engineer.

3.05 FINAL CLEANUP:

- A. Before acceptance by the Owner, the Contractor shall perform a final cleanup to bring the construction site to its original or specified condition. This cleanup shall include removing all trash and debris off of the premises. Before acceptance, the Engineer shall approve the condition of the site.

END OF SECTION

\\Wse03.local\WSE\Projects\MA\Boston MA\McConnell Playground\Permitting\NOI playground construction\Appendix D Specs\SECTION 01740-Cleaning Up.docx

Appendix E

AFFIDAVIT OF SERVICE

Under the Massachusetts Wetlands Protection Act

I, Alexandra Gaspar, hereby certify under the Pains and Penalties of Perjury that on February 3, 2021 I gave notification to abutters in compliance with the second paragraph of Massachusetts General Laws, Chapter 131, Section 40, and the DEP Guide to Abutter Notification dated, April 8, 1994, in connection with the following matter:

A Notice of Intent has been filed under the Massachusetts Wetlands Protection Act by the City of Boston Parks and Recreation Department with the Boston Conservation Commission on February 3, 2021 for property located at McConnell Park off of Springdale Street in Boston

The completed notification and a list of the abutters to whom it was given and their addresses, are attached to this Affidavit of Service.



Name: Alexandra Gaspar
Title: Environmental Scientist
Organization: Weston & Sampson Engineers, Inc

February 3, 2021
DATE



BABEL NOTICE

English:

IMPORTANT! This document or application contains **important information** about your rights, responsibilities and/or benefits. It is crucial that you understand the information in this document and/or application, and we will provide the information in your preferred language at no cost to you. If you need them, please contact us at cc@boston.gov or 617-635-3850.

Spanish:

¡IMPORTANTE! Este documento o solicitud contiene **información importante** sobre sus derechos, responsabilidades y/o beneficios. Es fundamental que usted entienda la información contenida en este documento y/o solicitud, y le proporcionaremos la información en su idioma preferido sin costo alguno para usted. Si los necesita, póngase en contacto con nosotros en el correo electrónico cc@boston.gov o llamando al 617-635-3850.

Haitian Creole:

AVI ENPÒTAN! Dokiman oubyen aplikasyon sa genyen **enfòmasyon ki enpòtan** konsènan dwa, responsablite, ak/oswa benefis ou yo. Li enpòtan ke ou konprann enfòmasyon ki nan dokiman ak/oubyen aplikasyon sa, e n ap bay enfòmasyon an nan lang ou prefere a, san ou pa peye anyen. Si w bezwen yo, tanpri kontakte nou nan cc@boston.gov oswa 617-635-3850.

Traditional Chinese:

非常重要！這份文件或是申請表格包含關於您的權利，責任，和／或福利的重要信息。請您務必完全理解這份文件或申請表格的全部信息，這對我們來說十分重要。我們會免費給您提供翻譯服務。如果您有需要請聯系我們的郵箱 cc@boston.gov 電話# 617-635-3850..

Vietnamese:

QUAN TRỌNG! Tài liệu hoặc đơn yêu cầu này chứa **thông tin quan trọng** về các quyền, trách nhiệm và/hoặc lợi ích của bạn. Việc bạn hiểu rõ thông tin trong tài liệu và/hoặc đơn yêu cầu này rất quan trọng, và chúng tôi sẽ cung cấp thông tin bằng ngôn ngữ bạn muốn mà không tính phí. Nếu quý vị cần những dịch vụ này, vui lòng liên lạc với chúng tôi theo địa chỉ cc@boston.gov hoặc số điện thoại 617-635-3850.

Simplified Chinese:

非常重要！这份文件或是申请表格包含关于您的权利，责任，和／或福利的重要信息。请您务必完全理解这份文件或申请表格的全部信息，这对我们来说十分重要。我们会免费给您提供翻译服务。如果您有需要请联系我们的邮箱 cc@boston.gov 电话# 617-635-3850.

Cape Verdean Creole:

INPURTANTI! Es dukumentu ó aplikason ten **informason inpur tanti** sobri bu direitus, rasponsabilidadi i/ó benefisius. Ê krusial ki bu intendi informason na es dukumentu i/ó aplikason ó nu ta da informason na língua di bu preferênsia sen ninhun kustu pa bó. Si bu prisiza del, kontata-nu na cc@boston.gov ó 617-635-3850.

Arabic:

مهم! يحتوي هذا المستند أو التطبيق على معلومات مهمة حول حقوقك ومسؤولياتك أو فوائدك. من الأهمية أن تفهم المعلومات الواردة في هذا المستند أو التطبيق. سوف نقدم المعلومات بلغتك المفضلة دون أي تكلفة عليك. إذا كنت في حاجة إليها، يرجى الاتصال بنا على cc@boston.gov أو 617-635-3850.

Russian:

ВАЖНО! В этом документе или заявлении содержится **важная информация** о ваших правах, обязанностях и/или льготах. Для нас очень важно, чтобы вы понимали приведенную в этом документе и/или заявлении информацию, и мы готовы бесплатно предоставить вам информацию на предпочитаемом вами языке. Если Вам они нужны, просьба связаться с нами по адресу электронной почты cc@boston.gov, либо по телефону 617-635-3850.

Portuguese:

IMPORTANTE! Este documento ou aplicativo contém **Informações importantes** sobre os seus direitos, responsabilidades e/ou benefícios. É importante que você compreenda as informações contidas neste documento e/ou aplicativo, e nós iremos fornecer as informações em seu idioma de preferência sem nenhum custo para você. Se precisar deles, fale conosco: cc@boston.gov ou 617-635-3850.

French:

IMPORTANT ! Ce document ou cette demande contient des **informations importantes** concernant vos droits, responsabilités et/ou avantages. Il est essentiel que vous compreniez les informations contenues dans ce document et/ou cette demande, que nous pouvons vous communiquer gratuitement dans la langue de votre choix. Si vous en avez besoin, veuillez nous contacter à cc@boston.gov ou au 617-635-3850.





**NOTIFICATION TO ABUTTERS
BOSTON CONSERVATION COMMISSION**

In accordance with the Massachusetts Wetlands Protection Act, Massachusetts General Laws Chapter 131, Section 40, and the Boston Wetlands Ordinance, you are hereby notified as an abutter to a project filed with the Boston Conservation Commission.

A. City of Boston Parks and Rec Dept has filed a Notice of Intent with the Boston Conservation Commission seeking permission to alter an Area Subject to Protection under the Wetlands Protection Act (General Laws Chapter 131, section 40) and Boston Wetlands Ordinance.

B. The address of the lot where the activity is proposed is **Springdale Street**

C. The project involves **Upgrades to McConnell Park/Playground**

D. Copies of the Notice of Intent may be obtained by contacting the Boston Conservation Commission at CC@boston.gov.

E. Copies of the Notice of Intent may be obtained from Weston & Sampson Engineers (Alexandra Gaspar) at 978-532-1900 or gaspara@wseinc.com between the hours of 8:00am - 5:00pm, M-F

F. In accordance with the Commonwealth of Massachusetts Executive Order Suspending Certain Provisions of the Open Meeting Law, the public hearing will take place **virtually** at <https://zoom.us/j/6864582044>. If you are unable to access the internet, you can call 1-929-205-6099, enter Meeting ID 686 458 2044 # and use # as your participant ID.

G. Information regarding the date and time of the public hearing may be obtained from the **Boston Conservation Commission** by emailing CC@boston.gov or calling **(617) 635-3850** between the hours of **9 AM to 5 PM, Monday through Friday**.

NOTE: Notice of the public hearing, including its date, time, and place, will be published at least five (5) days in advance in the **Boston Herald**.

NOTE: Notice of the public hearing, including its date, time, and place, will be posted on www.boston.gov/public-notices and in Boston City Hall not less than forty-eight (48) hours in advance.

NOTE: If you would like to provide comments, you may attend the public hearing or send written comments to CC@boston.gov or Boston City Hall, Environment Department, Room 709, 1 City Hall Square, Boston, MA 02201

NOTE: You also may contact the Boston Conservation Commission or the Department of Environmental Protection Northeast Regional Office for more information about this application or the Wetlands Protection Act. To contact DEP, call: the Northeast Region: (978) 694-3200.



**NOTIFICACIÓN PARA PROPIETARIOS Y/O VECINOS COLINDANTES
COMISIÓN DE CONSERVACIÓN DE BOSTON**

De conformidad con la Ley de protección de los humedales de Massachusetts, el Capítulo 131, Sección 40 de las Leyes Generales de Massachusetts y la Ordenanza sobre los humedales de Boston, por la presente queda usted notificado como propietario o vecino colindante de un proyecto presentado ante la Comisión de Conservación de Boston.

Departamento de Parques y
Recreación de Boston

A. ha presentado una solicitud a la Comisión de Conservación de Boston pidiendo permiso para modificar una zona sujeta a protección en virtud de la Ley de protección de los humedales (Leyes generales, capítulo 131, sección 40) y la Ordenanza sobre los humedales de Boston.

B. La dirección del lote donde se propone la actividad es McConnell Park, 30 Denny Street, Boston, MA 02125

C. El proyecto consiste en mejoras en los campos deportivos, el área de juegos, las áreas de pasivas y el estacionamiento.

D. Se pueden obtener copias del Aviso de Intención comunicándose con la Comisión de Conservación de Boston en CC@boston.gov.

E. Las copias de la notificación de intención pueden obtenerse en el representante del solicitante, Weston and Sampson, de lunes a viernes, entre las 8:00AM y las 5:00 PM contactando a Alexandra Gaspar at 978-532-1900 o por correo electrónico a través de gaspara@wseinc.com

F. De acuerdo con el Decreto Ejecutivo de la Mancomunidad de Massachusetts que suspende ciertas disposiciones de la Ley de reuniones abiertas, la audiencia pública se llevará a cabo virtualmente en <https://zoom.us/j/6864582044>. Si no puede acceder a Internet, puede llamar al 1-929-205-6099, ingresar ID de reunión 686 458 2044 # y usar # como su ID de participante.

G. La información relativa a la fecha y hora de la audiencia pública puede solicitarse a la **Comisión de Conservación de Boston** por correo electrónico a CC@boston.gov o llamando al (617) 635-4416 entre las 9 AM y las 5 PM, de lunes a viernes.

NOTA: La notificación de la audiencia pública, incluida su fecha, hora y lugar, se publicará en el **Boston Herald** con al menos cinco (5) días de antelación.

NOTA: La notificación de la audiencia pública, incluida su fecha, hora y lugar, se publicará en www.boston.gov/public-notices y en el Ayuntamiento de Boston con no menos de cuarenta y ocho (48) horas de antelación. Si desea formular comentarios, puede asistir a la audiencia pública o enviarlos por escrito a CC@boston.gov o al Ayuntamiento de Boston, Departamento de Medio Ambiente, Sala 709, 1 City Hall Square, Boston, MA 02201.

NOTA: También puede comunicarse con la Comisión de Conservación de Boston o con la Oficina Regional del Noreste del Departamento de Protección Ambiental para obtener más información sobre esta solicitud o la Ley de Protección de Humedales. Para comunicarse con el DEP, llame a la Región Noreste: (978) 694-3200.



City of Boston
Environment



City of Boston
Mayor Martin J. Walsh

NOTA: si tiene previsto asistir a la audiencia pública y necesita servicios de interpretación, sírvase informar al personal en CC@boston.gov antes de las 12 PM del día anterior a la audiencia.

PID	OWNER	ADDRESSEE	MLG_ADDRESS	MLG_CITYSTATE	MLG_ZIPCODE	LOC_ADDRESS	LOC_CITY	LOC_ZIPCODE
1302219000	M.B.T.A	M.B.T.A	125 SAVIN HILL AVE	DORCHESTER MA	02125	125 SAVIN HILL AV	DORCHESTER	02125
1302220000	COMMWLTH OF MASS	COMMWLTH OF MASS	SAVIN HILL AVE	DORCHESTER MA	02125	SAVIN HILL AV	DORCHESTER	02125
1302221000	DENNIS JENNIE C	DENNIS JENNIE C	24 HUBBARDSTON RD	DORCHESTER MA	02125	24 HUBBARDSTON RD	DORCHESTER	02125
1302222000	BRAHO GENTIAN	BRAHO GENTIAN	22 HUBBARDSTON RD	DORCHESTER MA	02125	22 HUBBARDSTON RD	DORCHESTER	02125
1302223000	NGUYEN LE THI	NGUYEN LE THI	20 HUBBARDSTON RD	DORCHESTER MA	02125	20 HUBBARDSTON RD	DORCHESTER	02125
1302224000	WONG MING TAO	WONG MING TAO	16 HUBBARDSTON RD	DORCHESTER MA	02125	16 HUBBARDSTON RD	DORCHESTER	02125
1302225000	PINI REVOCABLE TRUST	PINI REVOCABLE TRUST	12 HUBBARDSTON RD	DORCHESTER MA	02125	12 HUBBARDSTON RD	DORCHESTER	02125
1302226000	KERINS JOHN F	KERINS JOHN F	8 HUBBARDSTON RD	DORCHESTER MA	02125	8 HUBBARDSTON RD	DORCHESTER	02125
1302229000	SAVIN HILL CONDOMINIUM TR	SAVIN HILL CONDOMINIUM TR	141 SAVIN HILL AV	DORCHESTER MA	02125	141 SAVIN HILL AV	DORCHESTER	02125
1302229002	KERR THOMAS P	KERR THOMAS P	1 HARLOW ROAD	MARSHFIELD MA	02050	#A-11	DORCHESTER	02125
1302229004	BUTLER SUSAN	BUTLER SUSAN	141 SAVIN HILL AV #A-12	DORCHESTER MA	02125	141 SAVIN HILL AV #A-12	DORCHESTER	02125
1302229006	COTTER KRISTIN E	COTTER KRISTIN E	85 GLADSTONE ST #2	EAST BOSTON MA	02128	141 SAVIN HILL AV #B-11	DORCHESTER	02125
1302229008	SILVIUS HERMAN T III	SILVIUS HERMAN T III	1128 S E 17TH TE	CAPE CORAL FL DORCHESTER	33990	#B-12	DORCHESTER	02125
1302229010	PARKER JOSEPH A III	PARKER JOSEPH A III	141 SAVIN HILL AV #C-11	DORCHESTER MA	02125	141 SAVIN HILL AV #C-11	DORCHESTER	02125
1302229012	WYNNE RYAN M	WYNNE RYAN M	141 SAVIN HILL AV #C-12	DORCHESTER MA	02125	141 SAVIN HILL AV #C-12	DORCHESTER	02125
1302229014	NASH PAUL S	NASH PAUL S	141 SAVIN HILL AV #C-13	DORCHESTER MA	02125	141 SAVIN HILL AV #C-13	DORCHESTER	02125
1302229016	MACKINNON NATHAN R	MACKINNON NATHAN R	141 SAVIN HILL AV #A-21	DORCHESTER MA	02125	141 SAVIN HILL AV #A-21	DORCHESTER	02125
1302229018	QUEALLY KEVIN	QUEALLY KEVIN	141 SAVIN HILL AV #A-22	DORCHESTER MA	02125	141 SAVIN HILL AV #A-22	DORCHESTER	02125
1302229020	QUEALLY KEVIN	QUEALLY KEVIN	141 SAVIN HILL AV #B-21	DORCHESTER MA	02125	141 SAVIN HILL AV #B-21	DORCHESTER	02125
1302229022	FAZIO IRENE R	FAZIO IRENE R	141 SAVIN HILL AV #B-22	DORCHESTER MA	02125	141 SAVIN HILL AV #B-22	DORCHESTER	02125
1302229024	EDWARDS KAREN	EDWARDS KAREN	141 SAVIN HILL AV #B-23	DORCHESTER MA	02125	141 SAVIN HILL AV #B-23	DORCHESTER	02125
1302229026	THIBODEAU BETH MARY	THIBODEAU BETH MARY	141 SAVIN HILL AV #C-21	DORCHESTER MA	02125	141 SAVIN HILL AV #C-21	DORCHESTER	02125
1302229028	POWERS PATRICIA C	POWERS PATRICIA C	141 SAVIN HILL AV #C-22	DORCHESTER MA	02125	141 SAVIN HILL AV #C-22	DORCHESTER	02125

1302229030	CATALDO CRISTINA	CATALDO CRISTINA	141 SAVIN HILL AV #C-23	DORCHESTER MA	02125	141 SAVIN HILL AV #C-23	DORCHESTER	02125
1302229032	RODRIGUEZ EDUARDO	RODRIGUEZ EDUARDO	141 SAVIN HILL AV #A-31	DORCHESTER MA	02125	141 SAVIN HILL AV #A-31	DORCHESTER	02125
1302229034	CONNORS KATHERINE	CONNORS KATHERINE	141 SAVIN HILL AV #1-32	DORCHESTER MA	02125	141 SAVIN HILL AV #A-32	DORCHESTER	02125
1302229036	TEROVA KRISTI	TEROVA KRISTI	141 SAVIN HILL AV #B-31	DORCHESTER MA	02125	141 SAVIN HILL AV #B-31	DORCHESTER	02125
1302229038	QUICK MICHAEL J	QUICK MICHAEL J	141 SAVIN HILL AV #B-32	DORCHESTER MA	02125	141 SAVIN HILL AV #B-32	DORCHESTER	02125
1302229040	CATALDO BRIAN	CATALDO BRIAN	141 SAVIN HILL AV #B-33	DORCHESTER MA	02125	141 SAVIN HILL AV #B-33	DORCHESTER	02125
1302229042	WONG HENRIETTA YUK-HING	WONG HENRIETTA YUK-HING	141 SAVIN HILL AV #C-31	DORCHESTER MA	02125	141 SAVIN HILL AV #C-31	DORCHESTER	02125
1302229044	FOSTER VANESSA JOHNSON	FOSTER VANESSA JOHNSON	141 SAVIN HILL AV #C-32	DORCHESTER MA	02125	141 SAVIN HILL AV #C-32	DORCHESTER	02125
1302229046	SULLIVAN ALENA V	SULLIVAN ALENA V	141 SAVIN HILL AV #C-33	DORCHESTER MA	02125	141 SAVIN HILL AV #C-33	DORCHESTER	02125
1302230000	COOPER KAREN E	COOPER KAREN E	153 SAVIN HILL AV &	DORCHESTER MA	02125	153 SAVIN HILL AV	DORCHESTER	02125
1302231000	FITZSIMONS PATRICIA A THOMAS F AND BEATRICE M	FITZSIMONS PATRICIA A THOMAS F AND BEATRICE M	155 SAVIN HILL AV	DORCHESTER MA	02125	155 SAVIN HILL AV	DORCHESTER	02125
1302232000			252 SAVIN HILL AV	DORCHESTER MA	02125	9 PLAYSTEAD RD	DORCHESTER	02125
1302233000	DRURY CATHERINE ANN	DRURY CATHERINE ANN	11 WOODLAND DR	COHASSET MA	02025	11 PLAYSTEAD RD	DORCHESTER	02125
1302234000	MONROE CHARLES H	MONROE CHARLES H	15 PLAYSTEAD RD	DORCHESTER MA	02125	15 PLAYSTEAD RD	DORCHESTER	02125
1302235000	ERRICO DONALD J JR	ERRICO DONALD J JR	19 PLAYSTEAD RD	DORCHESTER MA	02125	19 17 PLAYSTEAD RD	DORCHESTER	02125
1302236000	PAVIDIS MARTHA J	PAVIDIS MARTHA J	23 PLAYSTEAD RD	DORCHESTER MA	02125	23 PLAYSTEAD RD	DORCHESTER	02125
1302237000	CITY OF BOSTON BY FCL	CITY OF BOSTON BY FCL	SPRINGDALE ST	DORCHESTER MA	02125	31 SPRINGDALE ST	DORCHESTER	02125
1302238000	CITY OF BOSTON COMMONWEALTH OF MASS	CITY OF BOSTON COMMONWEALTH OF MASS	SPRINGDALE	DORCHESTER MA	02125	SPRINGDALE ST	DORCHESTER	02125
1302238001	DOR YACHT CLUB INC	DOR YACHT CLUB INC	SPRINGDALE	DORCHESTER MA	02125	SPRINGDALE ST	DORCHESTER	02125
1302238002	LESSEE	LESSEE	100 PLAYSTEAD RD	DORCHESTER MA	02125	SPRINGDALE ST	DORCHESTER	02125
1302240000	CITY OF BOSTON	CITY OF BOSTON	RAILROAD	DORCHESTER MA	02125	RAILROAD ST	DORCHESTER	02125
1302250000	EATON PAUL R	EATON PAUL R	159 SAVIN HILL AV #2	DORCHESTER MA	02125	159 SAVIN HILL AV	DORCHESTER	02125
1302251000	PATTON MATTHEW D	PATTON MATTHEW D	161 SAVIN HILL AVE	DORCHESTER MA	02125	161 SAVIN HILL AV	DORCHESTER	02125
1302252000	CROWELL JONATHAN C	CROWELL JONATHAN C	165 SAVIN HILL AV	DORCHESTER MA	02125	165 SAVIN HILL AV	DORCHESTER	02125

1302253000	ONE 69 SAVIN HILL AVENUE	ONE 69 SAVIN HILL AVENUE	169 SAVIN HILL AV	DORCHESTER MA	02125	169 167 SAVIN HILL AV	DORCHESTER	02125
1302253002	AMARAL BRIAN J	AMARAL BRIAN J	40 WATERHOUSE ST	SOMERVILLE MA	02144	169 SAVIN HILL AV #1	DORCHESTER	02125
1302253004	CAHILL JOHN V JR	CAHILL JOHN V JR	169 SAVIN HILL AV #2	DORCHESTER MA	02125	169 SAVIN HILL AV #2	DORCHESTER	02125
1302253006	SEGALINI NICOLE E	SEGALINI NICOLE E	169 SAVIN HILL AV #3	DORCHESTER MA	02125	169 SAVIN HILL AV #3	DORCHESTER	02125
1302254000	ONE-71-173 SAVIN HILL AVENUE	ONE-71-173 SAVIN HILL AVENUE	171-173 SAVIN HILL AVENUE	DORCHESTER MA	02125	173 171 SAVIN HILL AV	DORCHESTER	02125
1302254002	KELLEY DAVID	KELLEY DAVID	171-173 SAVIN HILL AVE #1	DORCHESTER MA	02125	171 173 SAVIN HILL AV #1	DORCHESTER	02125
1302254004	JURKIEWICZ CHARLES	JURKIEWICZ CHARLES	29 MILL ST	DORCHESTER MA	02122	171 173 SAVIN HILL AV #2	DORCHESTER	02125
1302254006	MCMENAMY KELSEY R	MCMENAMY KELSEY R	171-173 SAVIN HILL AV # 3	DORCHESTER MA	02125	171 173 SAVIN HILL AV #3	DORCHESTER	02125
1302254008	JURKIWEICZ CHARLES	JURKIWEICZ CHARLES	171-173 SAVIN HILL AV # A	DORCHESTER MA	02125	171 173 SAVIN HILL AV	DORCHESTER	02125
1302254010	MCMENAMY KELSEY R	MCMENAMY KELSEY R	171-173 SAVIN HILL AV # B	DORCHESTER MA	02125	171 173 SAVIN HILL AV	DORCHESTER	02125
1302255000	KENNEDY JAMES D ETAL	KENNEDY JAMES D ETAL	9 DENNY	DORCHESTER MA	02125	9 DENNY ST	DORCHESTER	02125
1302256000	PELLEGRINO FRANCIS R	PELLEGRINO FRANCIS R	15 DENNY ST	DORCHESTER MA	02125	15 13 DENNY ST	DORCHESTER	02125
1302257000	MARTINI VALBONA	MARTINI VALBONA	19 DENNY ST	DORCHESTER MA	02125	19 17 DENNY ST	DORCHESTER	02125
1302258000	HILL JEFFERY S	HILL JEFFERY S	23 DENNY ST	DORCHESTER MA	02125	23 21 DENNY ST	DORCHESTER	02125
1302259000	OSULLIVAN ROBERT F JR	OSULLIVAN ROBERT F JR	25 DENNY ST	DORCHESTER MA	02125	25 DENNY ST	DORCHESTER	02125
1302260000	SMEGLIN ANDREA J	SMEGLIN ANDREA J	44 SPRINGDALE ST	DORCHESTER MA	02125	44 SPRINGDALE ST	DORCHESTER	02125
1302261000	GARSDIE CHRISTOPHER J	GARSDIE CHRISTOPHER J	28 PLAYSTEAD RD	DORCHESTER MA	02125	28 30 PLAYSTEAD RD	DORCHESTER	02125
1302262000	STASA GJERGJI	STASA GJERGJI	26 PLAYSTEAD RD	BOSTONMA DORCHESTER	02125	24 26 PLAYSTEAD RD	DORCHESTER	02125
1302263000	BARBUTO PETER F ETAL	BARBUTO PETER F ETAL	20 PLAYSTEAD RD	DORCHESTER MA	02125	20 PLAYSTEAD RD	DORCHESTER	02125
1302264000	SIMMONS JULIE A	SIMMONS JULIE A	27 BOUTWELL ST	DORCHESTER MA	02122	18 16 PLAYSTEAD RD	DORCHESTER	02125
1302265000	TWELVE- 14 PLAYSTEAD ROAD	TWELVE- 14 PLAYSTEAD ROAD	12 14 PLAYSTEAD RD	DORCHESTER MA	02125	14 12 PLAYSTEAD RD	DORCHESTER	02125
1302265002	DAKO GJERGJI	DAKO GJERGJI	12-14 PLAYSTEAD RD #1	DORCHESTER MA	02125	12 14 PLAYSTEAD RD #1	DORCHESTER	02125
1302265004	STICKNEY DAVID	STICKNEY DAVID	12-14 PLAYSTEAD RD #2	DORCHESTER MA	02125	12 14 PLAYSTEAD RD #2	DORCHESTER	02125
1302265006	LAVALLEE HOLLYANN	LAVALLEE HOLLYANN	12-14 PLAYSTEAD RD #3	DORCHESTER MA	02125	12 14 PLAYSTEAD RD #3	DORCHESTER	02125

1302266000	FENTON EILEEN	FENTON EILEEN	71 MAYFIELD ST	DORCHESTER MA	02125	10 PLAYSTEAD RD	DORCHESTER	02125
1302267000	FLANIGAN DARCIÉ	FLANIGAN DARCIÉ	28 DENNY ST	DORCHESTER MA	02125	28 DENNY ST	DORCHESTER	02125
1302268000	CROSBY PHILIP P	CROSBY PHILIP P	24 DENNY ST	DORCHESTER MA	02125	24 DENNY ST	DORCHESTER	02125
1302268002	WILLIAM J LAUBENSTEIN	WILLIAM J LAUBENSTEIN	50 INDIAN RD	WALTHAM MA DORCHESTER	02451	24 DENNY ST #1	DORCHESTER	02125
1302268004	CROSBY PHILIP P	CROSBY PHILIP P	24 DENNY ST #2	MA DORCHESTER	02125	24 DENNY ST #2	DORCHESTER	02125
1302268006	KELLY MAUREEN HAMILTON FAMILY	KELLY MAUREEN HAMILTON FAMILY	24 DENNY ST #3	MA DORCHESTER	02125	24 DENNY ST #3	DORCHESTER	02125
1302268008	TRUST OF	TRUST OF	135 SAVIN HILL AV	MA DORCHESTER	02125	24 DENNY ST #4	DORCHESTER	02125
1302268010	HOPE MARGARET D	HOPE MARGARET D	24 DENNY ST #5	MA DORCHESTER	02125	24 DENNY ST #5	DORCHESTER	02125
1302268012	FRASER RICHARD J III	FRASER RICHARD J III	24 DENNY ST #6	MA DORCHESTER	02125	24 DENNY ST #6	DORCHESTER	02125
1302268020	PORTER ARTHUR J	PORTER ARTHUR J	15 BAYSIDE ST	MA DORCHESTER	02125	18 DENNY ST	DORCHESTER	02125
1302268030	FINNIGAN JANICE M	FINNIGAN JANICE M	12 DENNY ST	MA DORCHESTER	02125	12 DENNY ST	DORCHESTER	02125
1302269000	BALAS JULIA ONE-75 SAVIN HILL AV	BALAS JULIA ONE-75 SAVIN HILL AV	8 DENNY	MA DORCHESTER	02125	8 DENNY ST	DORCHESTER	02125
1302270000	CONDO	CONDO	175 SAVIN HILL AVE #1	MA DORCHESTER	02125	175 SAVIN HILL AV	DORCHESTER	02125
1302270002	REYNOLDS JACQUELINE L	REYNOLDS JACQUELINE L	175 SAVIN HILL AV # 1	MA DORCHESTER	02125	175 SAVIN HILL AV #1	DORCHESTER	02125
1302270004	COSTELLO SEAN T	COSTELLO SEAN T	175 SAVIN HILL AV # 2	MA CHESTNUT HILL	02125	175 SAVIN HILL AV #2	DORCHESTER	02125
1302270006	GENNARO SUSAN CAMPBELL DENNIS M	GENNARO SUSAN CAMPBELL DENNIS M	97 ALGONQUIN RD	MA DORCHESTER	02467	175 SAVIN HILL AV #3	DORCHESTER	02125
1302271000	ETAL	ETAL	177 SAVIN HILL AVE	MA DORCHESTER	02125	177 SAVIN HILL AV	DORCHESTER	02125
1302272000	DOZ JULIA	DOZ JULIA	3 BAYSIDE	MA DORCHESTER	02125	SAVIN HILL AV	DORCHESTER	02125
1302273000	DOZ JULIA	DOZ JULIA	3 BAYSIDE	MA DORCHESTER	02125	3 BAYSIDE ST	DORCHESTER	02125
1302274000	KRAJEWSKI NATALJA NINE BAYSIDE ST CONDO	KRAJEWSKI NATALJA NINE BAYSIDE ST CONDO	5 BAYSIDE	MA DORCHESTER	02125	5 BAYSIDE ST	DORCHESTER	02125
1302275000	TR	TR	PO BOX 123	HANOVER MA WALLINGFORD	02339	9 BAYSIDE ST	DORCHESTER	02125
1302275002	TRACY SIOBHAN	TRACY SIOBHAN	51 SUMMERWOOD DRIVE	CT DORCHESTER	06492	9 BAYSIDE ST #1	DORCHESTER	02125
1302275004	JABLONSKI MICHAEL J	JABLONSKI MICHAEL J	9 BAYSIDE ST #2	MA DORCHESTER	02125	9 BAYSIDE ST #2	DORCHESTER	02125
1302275006	PAULEY ELIZABETH A	PAULEY ELIZABETH A	9 BAYSIDE ST #3	MA DORCHESTER	02125	9 BAYSIDE ST #3	DORCHESTER	02125

1302276000	KESMICH LLC	KESMICH LLC	17 STONEGATE LANE	WESTWOOD MA	02090	15 BAYSIDE ST	DORCHESTER	02125
1302277000	OLEARY DAVID D MACNEIL FAMILY	OLEARY DAVID D MACNEIL FAMILY	19 BAYSIDE ST	MA DORCHESTER	02125	19 BAYSIDE ST	DORCHESTER	02125
1302278000	IRREVOCABLE EIGHTEEN BAYSIDE ST	IRREVOCABLE EIGHTEEN BAYSIDE ST	23 BAYSIDE ST	MA	02125	23 BAYSIDE ST	DORCHESTER	02125
1302284000	CONDO TR	CONDO TR	80 HAZLEWOOD DR	NORWOOD MA DORCHESTER	02062	18 BAYSIDE ST	DORCHESTER	02125
1302284002	HARVEY RYAN D	HARVEY RYAN D	18 BAYSIDE ST #1	MA DORCHESTER	02125	18 BAYSIDE ST #1	DORCHESTER	02125
1302284004	ROBIDEAU DUSTIN T	ROBIDEAU DUSTIN T	18 BAYSIDE ST UNIT 3	MA E FALMOUTH	02125	18 BAYSIDE ST #2	DORCHESTER	02125
1302284006	ROBIDEAU DUSTIN	ROBIDEAU DUSTIN	56 WHITECAPS DR	MA DORCHESTER	02536	18 BAYSIDE ST #3	DORCHESTER	02125
1302285000	CREMIN IRENE M	CREMIN IRENE M	14 BAYSIDE ST	MA	02125	14 BAYSIDE ST	DORCHESTER	02125
1302286000	CUSICK SCOTT ONE 83 SAVIN HILL	CUSICK SCOTT ONE 83 SAVIN HILL	6 READ DRIVE	HANOVER MA DORCHESTER	02339	10 BAYSIDE ST	DORCHESTER	02125
1302287000	AVENUE QUARTARONE FRANK	AVENUE QUARTARONE FRANK	183 SAVIN HILL AV	MA DORCHESTER	02125	183 SAVIN HILL AV	DORCHESTER	02125
1302287002	ANTHONY	ANTHONY	183 SAVIN HILL AV #1	MA DORCHESTER	02125	183 SAVIN HILL AV #1	DORCHESTER	02125
1302287004	BRADSHAW KELLEY	BRADSHAW KELLEY	183 SAVIN HILL AV #2	MA DORCHESTER	02125	183 SAVIN HILL AV #2	DORCHESTER	02125
1302287006	GRIFFIN ALISON ONE-85 SAVIN HILL AV	GRIFFIN ALISON ONE-85 SAVIN HILL AV	183 SAVIN HILL AV #3	MA DORCHESTER	02125	183 SAVIN HILL AV #3	DORCHESTER	02125
1302288000	CONDO	CONDO	185 SAVIN HILL AV	MA DORCHESTER	02125	185 SAVIN HILL AV	DORCHESTER	02125
1302288002	DOUGLASS MATTHEW C FEDERAL NATIONAL	DOUGLASS MATTHEW C FEDERAL NATIONAL	185 SAVIN HILL AV #1	MA DORCHESTER	02125	185 SAVIN HILL AV #1	DORCHESTER	02125
1302288004	MORTGAGE	MORTGAGE	185 SAVIN HILL AV #2	MA DORCHESTER	02125	185 SAVIN HILL AV #2	DORCHESTER	02125
1302288006	LEE JONATHAN M	LEE JONATHAN M	185 SAVIN HILL AVE #3	MA DORCHESTER	02125	185 SAVIN HILL AV #3	DORCHESTER	02125
1302289000	HASSON JAMES G	HASSON JAMES G	189 SAVIN HILL AV	MA DORCHESTER	02125	189 SAVIN HILL AV	DORCHESTER	02125
1302290000	BOROWICZ IRENE V	BOROWICZ IRENE V	191 SAVIN HILL AVE	MA DORCHESTER	02125	191 SAVIN HILL AV	DORCHESTER	02125
1302291000	SZCZESNY STELLA	SZCZESNY STELLA	5 SOUTH VIEW	MA DORCHESTER	02125	5 7 SOUTHVIEW ST	DORCHESTER	02125
1302292000	9 SOUTHVIEW STREET	9 SOUTHVIEW STREET	9 SOUTHVIEW ST	MA DORCHESTER	02122	9 SOUTHVIEW ST	DORCHESTER	02125
1302292002	BUSCAGLIA JOSE	BUSCAGLIA JOSE	9 SOUTHVIEW ST #1	MA DORCHESTER	02125	9 SOUTHVIEW ST #1	DORCHESTER	02125
1302292004	VORENBERG STEPHEN C	VORENBERG STEPHEN C	9 SOUTHVIEW ST #2	MA	02125	9 SOUTHVIEW ST #2	DORCHESTER	02125
1302293000	ROSS ROBERT C	ROSS ROBERT C	65 HOWE ST	QUINCY MA	02169	18 20 SOUTHVIEW ST	DORCHESTER	02125

1302294000	HARRISON CHRISTOPHER BE	HARRISON CHRISTOPHER BE	14 SOUTHVIEW ST	DORCHESTER MA	02125	14 16 SOUTHVIEW ST	DORCHESTER	02125
1302295000	CIULLA MICHAEL A	CIULLA MICHAEL A	10 SOUTHVIEW ST	DORCHESTER MA	02125	10 12 SOUTHVIEW ST	DORCHESTER	02125
1302296000	DAVIS KURT E	DAVIS KURT E	6 SOUTHVIEW ST	DORCHESTER MA	02125	6 8 SOUTHVIEW ST	DORCHESTER	02125
1302297000	SZKOLKA MARCIA R	SZKOLKA MARCIA R	193 SAVIN HILL AVE	DORCHESTER MA	02125	193 SAVIN HILL AV	DORCHESTER	02125
1302298000	MURPHY PAUL	MURPHY PAUL	270 TAPPAN ST	BROOKLINE MA	02445	195 SAVIN HILL AV	DORCHESTER	02125
1302299000	CLAIRE M CRONIN BE	CLAIRE M CRONIN BE	199 SAVIN HILL AVE	DORCHESTER MA	02125	199 SAVIN HILL AV	DORCHESTER	02125
1302300000	201 SAVIN HILL AVENUE	201 SAVIN HILL AVENUE	201 SAVIN HILL AVE	DORCHESTER MA	02125	201 SAVIN HILL AV	DORCHESTER	02125
1302300002	COLE JENNIFER RIVERS TAUBENBERGER	COLE JENNIFER RIVERS TAUBENBERGER	201 SAVIN HILL AVE #1	DORCHESTER MA	02125	201 SAVIN HILL AV #1	DORCHESTER	02125
1302300004	MICHAEL M	MICHAEL M	201 SAVIN HILL AVE #2	DORCHESTER MA	02125	201 SAVIN HILL AV #2	DORCHESTER	02125
1302300006	20 SAVIN HILL AVENUE TAUBENBERGER	20 SAVIN HILL AVENUE TAUBENBERGER	201 SAVIN HILL AVE #3	DORCHESTER MA	02125	201 SAVIN HILL AV #3	DORCHESTER	02125
1302300008	MICHAEL M	MICHAEL M	201 SAVIN HILL AVE #2	DORCHESTER MA	02125	201 SAVIN HILL AV	DORCHESTER	02125
1302300010	NUNEZ JACQUELINE M	NUNEZ JACQUELINE M	201 SAVIN HILL AVE #1	DORCHESTER MA	02125	201 SAVIN HILL AV	DORCHESTER	02125
1302300012	NUNEZ JACQUELINE M	NUNEZ JACQUELINE M	201 SAVIN HILL AVE #3	DORCHESTER MA	02125	201 SAVIN HILL AV	DORCHESTER	02125
1302301000	MCCOLGAN JOHN J	MCCOLGAN JOHN J	203 SAVIN HILL AV	DORCHESTER MA	02125	203 SAVIN HILL AV	DORCHESTER	02125
1302302000	FERRANDI ALICE L	FERRANDI ALICE L	205 SAVIN HILL AVE	DORCHESTER MA	02125	205 SAVIN HILL AV	DORCHESTER	02125
1302303000	CHOW ELAINE K	CHOW ELAINE K	207 SAVIN HILL AVE	DORCHESTER MA	02125	207 SAVIN HILL AV	DORCHESTER	02125
1302304000	SHORR ELIZABETH CLARK	SHORR ELIZABETH CLARK	211 SAVIN HILL AVE	DORCHESTER MA	02125	211 SAVIN HILL AV	DORCHESTER	02125
1302479000	ANASTAS ROBERT TWO-02 SAVIN HILL	ANASTAS ROBERT TWO-02 SAVIN HILL	206 SAVIN HILL AVE	DORCHESTER MA	02125	206 SAVIN HILL AV	DORCHESTER	02125
1302480000	ESTATE	ESTATE	202 SAVIN HILL AVE	DORCHESTER MA	02125	202 SAVIN HILL AV	DORCHESTER	02125
1302480002	TAI GABRIEL	TAI GABRIEL	202 SAVIN HILL AV #1	DORCHESTER MA	02125	202 SAVIN HILL AV #1	DORCHESTER	02125
1302480004	FERREIRA DANIEL	FERREIRA DANIEL	202 SAVIN HILL AV #2	DORCHESTER MA	02125	202 SAVIN HILL AV #2	DORCHESTER	02125
1302480006	COBB MICHAEL	COBB MICHAEL	202 SAVIN HILL AV #3	DORCHESTER MA	02125	202 SAVIN HILL AV #3	DORCHESTER	02125
1302481000	FORMAN AMY LYNN BOELITZ FAMILY	FORMAN AMY LYNN BOELITZ FAMILY	198 SAVIN HILL AV	DORCHESTER MA	02125	198 198A SAVIN HILL AV	DORCHESTER	02125
1302482000	IRREVOCABLE	IRREVOCABLE	196 SAVIN HILL AVE	DORCHESTER MA	02125	196 196A SAVIN HILL AV	DORCHESTER	02125

1302483000	MORRIS PATRICIA C	MORRIS PATRICIA C	17 WHITNEY ST	CHESTNUT HILL MA	02467	194 194A SAVIN HILL AV	DORCHESTER	02125
1302484000	RICH JOHN M	RICH JOHN M	192 SAVIN HILL AV	DORCHESTER MA	02125	192 192A SAVIN HILL AV	DORCHESTER	02125
1302485000	ONE 90 SAVIN HILL AV	ONE 90 SAVIN HILL AV	190 SAVIN HILL AV	DORCHESTER MA	02125	190 190A SAVIN HILL AV	DORCHESTER	02125
1302485002	LEMAR DARRELL	LEMAR DARRELL	190 SAVIN HILL AV #1	DORCHESTER MA	02125	190 SAVIN HILL AV #1	DORCHESTER	02125
1302485004	WALKER ADRIAN C	WALKER ADRIAN C	190 SAVIN HILL AV #2	DORCHESTER MA	02125	190 SAVIN HILL AV #2	DORCHESTER	02125
1302485006	LADE ABBEY N	LADE ABBEY N	190 SAVIN HILL AV	DORCHESTER MA	02125	190 SAVIN HILL AV #3	DORCHESTER	02125
1503090000	MASS BAY TRANSP AUTH	MASS BAY TRANSP AUTH	FREEPORT	DORCHESTER MA	02122	FREEPORT ST	DORCHESTER	02125
1503091000	PETER JUNKOVIC	PETER JUNKOVIC	150 FREEPORT ST	DORCHESTER MA	02125	150 FREEPORT ST	DORCHESTER	02125
1503130010	GADONI LLC	GADONI LLC	15 ELMER ST	CAMBRIDGE MA	02139	65 BAY ST	DORCHESTER	02125

Appendix F



westonandsampson.com

55 Walkers Brook Drive, Suite 100
Reading, MA 01867
tel: 978.532.1900

Wetland Delineation Report



March 2020

TOWN OF
Dorchester
MASSACHUSETTS

McConnell Park
Dorchester, MA



TABLE OF CONTENTS

	Page
1.0 SITE DESCRIPTION	1-1
2.0 DELINEATION OF WETLAND RESOURCES	2-1
2.1 Site Observations	2-1
2.2 Wetland Delineation Methodology	2-1
2.3 Coastal Beach	2-1
2.5 Other Protected Areas	2-2
3.0 SUMMARY	3-1
4.0 REFERENCES	4-1

FIGURES

Figure 1.....	Wetlands Field Map
Figure 2.....	USGS Topographic Map
Figure 3.....	FEMA FIRM Map
Figure 4.....	Environmental Resources Map

APPENDICES

Appendix A	Site Photographs
------------------	------------------

1.0 SITE DESCRIPTION

On March 2, 2020, the presence of wetland resources was investigated in the vicinity of McConnell Park in Dorchester, MA. This investigation area is located within a public park with beach access, adjacent to a residential neighborhood. McConnell Park is located along the shore of Dorchester Bay Basin. Please see Figure 1 (Wetlands Field Map) and Figure 2 (USGS Topographic Map) of this report for the investigation area.

A wetland resource area, Coastal Beach, was identified and flagged in the field using pink flagging by a Weston & Sampson employee who is trained in the wetland delineation process using the Massachusetts Department of Environmental Protection (MassDEP) and the US Army Corps of Engineers methodology. A further description of this wetland resource area is presented in the following sections.

2.0 DELINEATION OF WETLAND RESOURCES

2.1 Site Observations

The Weston & Sampson wetland scientist, trained in the ACOE Wetland Delineation Manual and Massachusetts Department of Environmental Protection (MassDEP) Delineating Bordering Vegetated Wetlands Under the Massachusetts Wetland Protection Act guidance document, observed the following protected wetland resources at the site:

- Coastal Beach

2.2 Wetland Delineation Methodology

Wetland delineation assessment was conducted in accordance to the Massachusetts Wetland Protection Act Regulations (310 CMR 10.55(2)(c)), Massachusetts Department of Environmental Protection (MassDEP) Delineating Bordering Vegetated Wetlands Under the Massachusetts Protection Act (March 1995), and ACOE Wetland Manual (Technical Report Y-87-1).

2.3 Coastal Beach

The Massachusetts Wetland Protection Act defines a Coastal Beach as “unconsolidated sediment subject to wave, tidal and coastal storm action which forms the gently sloping shore of a body of salt water and includes tidal flats.” A single Coastal Beach was delineated at the site. The limit of the Coastal Beach resource area is defined as “the dune line, coastal bankline or the seaward edge of existing human-made structures, when structures replace one of the above lines, whichever is closest to the ocean.” The landward edge of the Coastal Beach located at McConnel Park is defined by a man-made retaining wall, Top of Bank (TOB). Wetland flags left in the field included:

- TOB-A1 through TOB-A25 (Coastal Beach “A” series)

A 100-foot buffer zone is associated with the Coastal Beach resource area based on 310 CMR 10.02 ((2)(b) of the Massachusetts Wetlands Protection Act.

2.4 Other Protected Areas

Weston & Sampson created environmental resources maps (see Figure 4) of the site to determine the presence of other protected areas. The data source of these map layers was the Massachusetts Geographic Information System (MassGIS). These areas included:

- NHESP Priority Habitats of Rare Species
- NHESP Estimated Habitats of Rare Wildlife
- NHESP Certified and Potential Vernal Pools
- Areas of Critical Environmental Concern (ACEC)
- Outstanding Resource Waters (ORW)

Wetland resources identified in the field were also added to these maps. Based on the MassGIS information there are no protected areas other than the Coastal Beach wetland resource area previously identified.

FEMA Flood Insurance Rate Maps (FIRM) were created online from the FEMA website to determine if there is a 100-year flood zone at the site. See Figure 3 for FIRM map. Based on FEMA flood maps the investigation area is located within the 100-year flood zone.

3.0 SUMMARY

On March 2, 2020, the presence of wetland resources was investigated in the vicinity of McConnell Park in Dorchester, MA. A single Coastal Beach was identified and flagged at the site.

Additional environmental mapping was conducted using MassGIS data layers and FEMA FIRM mapping. This additional mapping indicates that there are no protected areas other than the Coastal Beach resource area previously identified however, the investigation area is located within the 100-year flood zone.

4.0 REFERENCES

- Jackson, Scott. 1995. "Delineating Bordering Vegetated Wetlands Under the Massachusetts Wetlands Protection Act." Massachusetts Department of Environmental Protection.
- Massachusetts Division of Fisheries and Wildlife, Natural Heritage and Endangered Species Program. Massachusetts Natural Heritage Atlas, 13th Edition with 2017 web updates. Accessed on 3/23/2020.
- Massachusetts Geographic Information System. January 2009. Outstanding Resource Waters. Massachusetts Department of Environmental Protection. Accessed on 3/23/2020.
- Massachusetts Geographic Information System. December 2003. Areas of Critical Environmental Concern. Massachusetts Department of Environmental Protection. Accessed on 3/23/2020.
- Newcomb, Lawrence. 1977. Newcomb's Wildflower Guide. Little, Brown and Company.
- Web Soil Survey of Suffolk County, Massachusetts. United States Department of Agriculture, Soil Conservation Service, in cooperation with Massachusetts Agricultural Experiment Station
- United States Department of Agriculture, Natural Resources Conservation Service. 2018. *Field Indicators of Hydric Soils in the United States, Version 8.2*. L. M. Vasilas, G. W. Hurt, and J.F. Berkowitz (eds.). USDA, NRCS, in cooperation with the National Technical Committee for Hydric Soils.
- USACOE, January 1987, Corps of Engineers Wetlands Delineation Manual, Wetlands Research Program Technical Report Y-87-1.
- FEMA Flood Map Service Center, online at msc.fema.gov/portal Assessed on 3/23/2020.
- Tiner, Jr., Ralph W., 2005, Field Guide to Nontidal Wetland Identification
- Tiner, Jr., Ralph W, 2009, Field Guide to Tidal Wetland Plants of the Northeastern United States and Neighboring Canada.
- Wojtec, Michael, Bard – A field Guide to Trees of the Northeast.
- New England Hydric Soils Technical Committee, 2019, Version 4, *Field Indicator of Identifying Hydric Soils in New England*. New England Interstate Water Pollution Control Commission, Lowell, MA.



USGS, MassGIS

Legend

-  Coastal Beach
-  Marsh/Bog
-  Wooded marsh
-  Cranberry Bog
-  Salt Marsh
-  Open Water
-  Reservoir (with PWSID)
-  Tidal Flats
-  Beach/Dune

FIGURE 1

McConnell Park
Dorchester, MA

Wetland Field Map

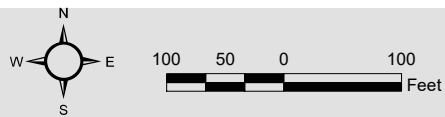

Data Source: Office of Geographic and Environmental Information (MassGIS),
Commonwealth of Massachusetts Executive Office of Environmental Affairs



Legend

 Investigation Area

FIGURE 2

McConnell Park
Dorchester, MA

USGS Topographic Map

Copyright © 2013 National Geographic Society, i-cubed

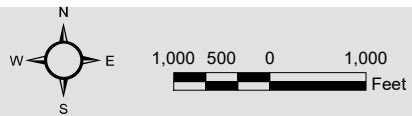

Data Source: Office of Geographic and Environmental Information (MassGIS),
Commonwealth of Massachusetts Executive Office of Environmental Affairs



National Flood Hazard Layer FIRMette

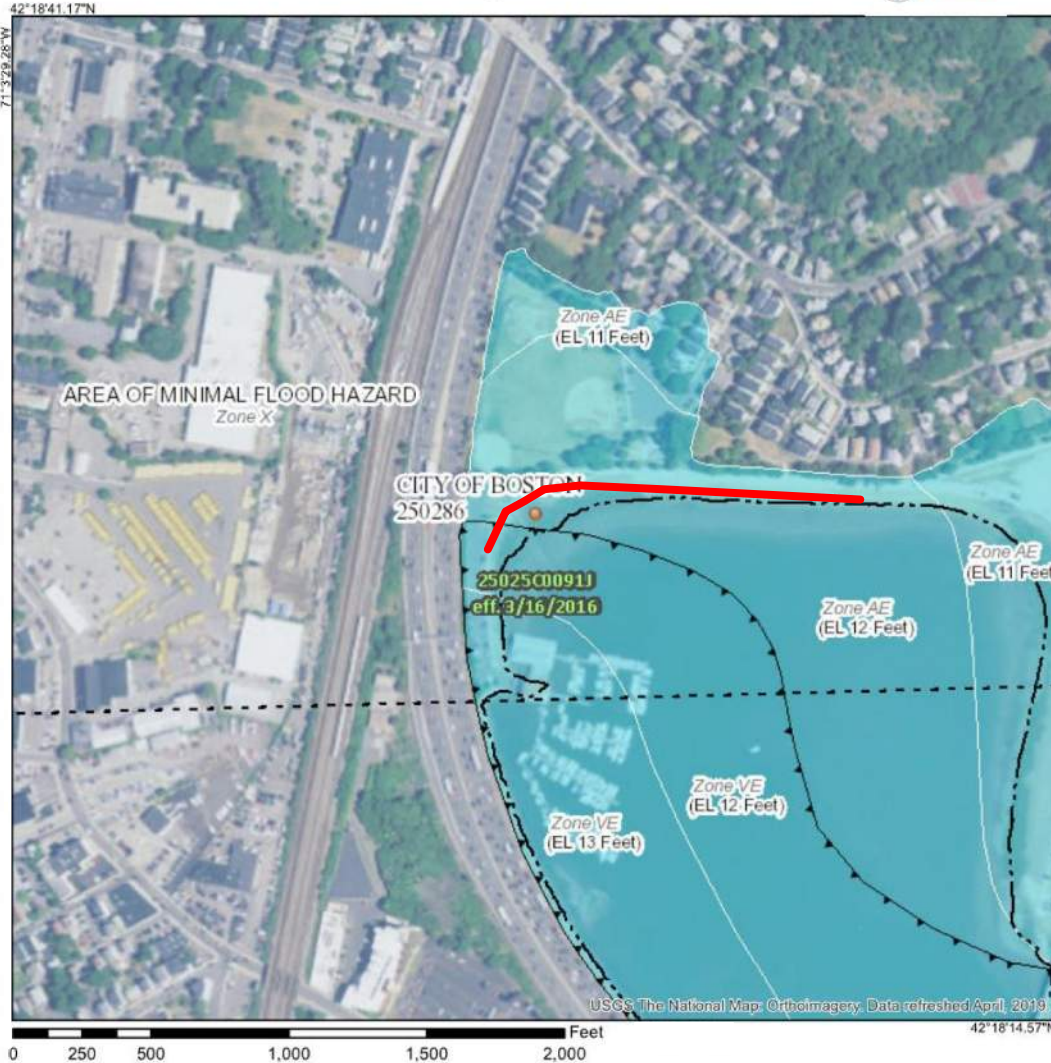

Legend

SEE FIS REPORT FOR DETAILED LEGEND AND INDEX MAP FOR FIRM PANEL LAYOUT

SPECIAL FLOOD HAZARD AREAS		Without Base Flood Elevation (BFE) <i>Zone A, V, AE</i>
		With BFE or Depth <i>Zone AE, AO, AH, VE, AR</i>
		Regulatory Floodway
OTHER AREAS OF FLOOD HAZARD		0.2% Annual Chance Flood Hazard. Areas of 1% annual chance flood with average depth less than one foot or with drainage areas of less than one square mile <i>Zone X</i>
		Future Conditions 1% Annual Chance Flood Hazard <i>Zone X</i>
		Area with Reduced Flood Risk due to Levee. See Notes. <i>Zone X</i>
		Area with Flood Risk due to Levee <i>Zone D</i>
OTHER AREAS		Area of Minimal Flood Hazard <i>Zone X</i>
		Effective LOMRs
		Area of Undetermined Flood Hazard <i>Zone D</i>
GENERAL STRUCTURES		Channel, Culvert, or Storm Sewer
		Levee, Dikes, or Floodwall
OTHER FEATURES		Cross Sections with 1% Annual Chance Water Surface Elevation
		Coastal Transect
		Base Flood Elevation Line (BFE)
		Limit of Study
		Jurisdiction Boundary
		Coastal Transect Baseline
		Profile Baseline
	Hydrographic Feature	
MAP PANELS		Digital Data Available
		No Digital Data Available
		Unmapped

The pin displayed on the map is an approximate point selected by the user and does not represent an authoritative property location.

This map complies with FEMA's standards for the use of digital flood maps if it is not void as described below. The basemap shown complies with FEMA's basemap accuracy standards.

The flood hazard information is derived directly from the authoritative NFHL web services provided by FEMA. This map was exported on 4/6/2020 at 11:31:42 AM and does not reflect changes or amendments subsequent to this date and time. The NFHL and effective information may change or become superseded by new data over time.

This map image is void if the one or more of the following map elements do not appear basemap imagery, flood zone labels, legend, scale bar, map creation date, community identifiers, FIRM panel number, and FIRM effective date. Map images for unmapped and unmodernized areas cannot be used for regulatory purposes.

Legend
 Investigation Area

FIGURE 3

McConnell Park
Dorchester, MA

FEMA Map



Legend









-  Coastal Beach
- ACECs**
-  ACECs
- NHESP Habitats**
-  NHESP Estimated Habitats of Rare Wildlife
-  NHESP Priority Habitats of Rare Species
-  NHESP Certified Vernal Pools
-  NHESP Potential Vernal Pools
- Outstanding Resource Waters**
-  Public Water Supply Contributor
-  ORW for ACEC
-  ORW for both Water Supply and Other

FIGURE 4

McConnell Park
Dorchester, MA

Environmental Resources Map

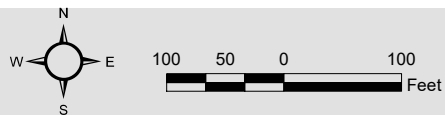

Data Source: Office of Geographic and Environmental Information (MassGIS),
Commonwealth of Massachusetts Executive Office of Environmental Affairs

APPENDIX A

Site Photographs



Photo 1: McConnell Park



Photo 2: Retaining Wall Adjacent to Coastal Beach

Appendix G



Photo 1: Lower Path



Photo 2: Official Little League Field



Photo 3: Playground Area



Photo 4: Beach Area

Appendix H



The Commonwealth of Massachusetts
Executive Office of Energy and Environmental Affairs
100 Cambridge Street, Suite 900
Boston, MA 02114

Charles D. Baker
GOVERNOR

Karyn E. Polito
LIEUTENANT GOVERNOR

Kathleen A. Theoharides
SECRETARY

Tel: (617) 626-1000
Fax: (617) 626-1081
<http://www.mass.gov/eea>

January 29, 2021

CERTIFICATE OF THE SECRETARY OF ENERGY AND ENVIRONMENTAL AFFAIRS
ON THE
ENVIRONMENTAL NOTIFICATION FORM

PROJECT NAME : McConnell Park Improvements
PROJECT MUNICIPALITY : Boston (Dorchester)
PROJECT WATERSHED : Boston Harbor
EEA NUMBER : 16305
PROJECT PROPONENT : Boston Parks and Recreation Department
DATE NOTICED IN MONITOR : December 23, 2020

Pursuant to the Massachusetts Environmental Policy Act (MEPA; M.G. L. c. 30, ss. 61-62I) and Section 11.06 of the MEPA regulations (301 CMR 11.00), I hereby determine that this project **does not require** an Environmental Impact Report (EIR). However, as indicated in the Office of Coastal Zone Management (CZM)'s comment letter, concerns remain regarding the potential channelization of flood waters as a result of the grade changes proposed as part of the project. The City of Boston should continue to study the impacts the project may have on surroundings residential areas, particularly during less frequent, more intense coastal storm events.

Project Description

As described in the Environmental Notification Form (ENF), the project consists of improvements to the City of Boston's McConnell Park located in the Savin Hill Neighborhood of Dorchester. Improvements include upgrading park amenities; providing a dry parking area during extreme storm events; creating a dedicated emergency access route from Playstead to Denny Street via Springdale Street; and upgrading the stormwater management system to allow the park to recover from flood events more quickly. Amenity upgrades will include the reconstruction of a natural turf little

league field and softball field; construction of a new synthetic challenger league¹ field and an expanded and upgraded playground area. Improvements to the parking lot include an improved parking lot with designated emergency access; a pedestrian plaza with traffic calming measures; and tree planting to increase canopy shade. This project will construct a new emergency access route to connect Playstead Road and Denny Street via Springdale Street which is currently only exists as paper street² which runs through the parking lot. The project will provide striping of the parking lot with enforcement signage. Additional site improvements include street lighting and security cameras, paved walkways, spectator seating areas, portable restroom shelter, site furnishings, and planting areas.

Existing flood pathways enter the project site from Dorchester Bay through the third baseline of the central ballfield adjacent to the Harborwalk. The pathway traverses the topographic low points through the athletic fields towards the existing parking lot, across Springdale Street and into the rear properties of two residential abutters currently on the north side of Springdale Street. The project includes raising portions of the park at or above 18 ft Boston City Base (BCB) which is the projected base flood elevation in 2050, as described in the ENF. The project includes increasing the elevation of Springdale street by 2.5 to 3.5 feet to elevation 16.70 ft BCB and 17.41 ft BCB. The proposed parking area will be raised by up to four feet for a final elevation ranging between 17.00 ft BCB and 19.60 ft BCB. A multipurpose plaza space which also serves as access for the nearby Dorchester Bay Yacht Club which extends seaward from the parking area will also be raised by approximately 5 ft to elevation 18.80 ft BCB. All other areas of the park and the proposed amenities below elevation 18.00 ft BCB are being topographically graded in a way that is to ensure improved stormwater collection, drainage, and recovery time presently and in the future. The proposed contouring and topography throughout the athletic fields will range from 0 to 1 feet of fill and transition back to existing grades at the eastern limits of the park.

The project involves upgrading the stormwater management system to allow the park to recover from flood events more quickly. The proposed stormwater design includes the collection and treatment of stormwater to vegetated areas and into area drains, subsurface lateral collection pipes, storage chambers and deep sump hooded catch basins for treatment. Check valves will be installed at downstream drainpipe locations to mitigate upwelling during severe storm events.

Project Site

The approximately 7-acre project site is located at the base of Savin Hill and is bordered to the west by Interstate 93 (I-93), to the south and east by Massachusetts Department of Conservation and Recreation (DCR) owned Harborwalk and Dorchester Bay, and to the north by Springdale Street and a residential neighborhood. The existing park property consists of three natural turf softball fields on the western portion of the site, an impervious parking area and unofficial emergency access drive near the center of the site, and a lawn area with mature tree canopy to the east. The park is bisected by an impervious access drive which serves the adjacent Dorchester Yacht Club. The park also includes a children's playground on the southern edge of the park. Resource areas within the project site are limited to land subject to coastal storm flowage (LSCSF); however, the project site abuts DCR's harbor walk which is adjacent to Dorchester Bay and its coastal beach and coastal bank. The entire project site is LSCSF and is located in Zone AE with a base flood elevation of 11 ft and 12 ft NAVD88 (17.46/18.46 ft

¹ Challenger league is an adaptive baseball program for individuals with physical and intellectual disabilities.

² A paper street is a street or roadway that appears on maps but has not been built.

BCB) according to the Federal Emergency Management Act (FEMA) Flood Insurance Rate Map No. 25025C0091J.

Environmental Impacts and Mitigation

Environmental impacts associated with the project include the temporary disturbance of 6.1 acres of previously disturbed land and creation of 0.24 acres of new impervious surface (1.59 acres total). The project will result in the alteration of 6.1 acres (265,800 sf) of LSCSF. The project will add an additional 8 parking spaces (49 total). Measures to avoid, minimize and mitigate damage to the environment include upgrading the stormwater management system, improved tree canopy and installation of flood control measures. The project is intended to provide resiliency during future conditions as impacted by climate change, most notably, by elevating the parking lot area to the expected base flood elevation (BFE) for 100-year storm conditions in 2050 (which is the useful life identified for the project).

Jurisdiction and Permitting

This project is subject to MEPA review and preparation of an ENF pursuant to 301 CMR 11.03(3)(b)(1)(f) because it requires a State Agency Action and involves the alteration of one half or more acres of any other wetlands. The project requires a M.G.L. Chapter 91 License from the Massachusetts Department of Environmental Protection (MassDEP) and a Construction and Access Agreement from DCR because the project includes work along a shared property boundary with DCR.

The project requires an Order of Conditions from the Boston Conservation Commission, or in the case of an appeal, a Superseding Order of Conditions from MassDEP. It will require a National Pollutant Discharge Elimination System (NPDES) Stormwater General Permit from the United States Environmental Protection Agency (EPA). The project may require Federal Consistency Review from CZM.

The project is not receiving Financial Assistance from the Commonwealth. Therefore, MEPA jurisdiction for any future review would be limited to those aspects of the project that are within the subject matter of any required or potentially required Agency Actions and that may cause Damage to the Environment, as defined in the MEPA regulations.

Review of the ENF

The ENF provided a description of existing and proposed conditions, preliminary project plans, and an alternatives analysis, and identified measures to avoid, minimize and mitigate environmental impacts. Supplemental information was provided to the MEPA distribution list on January 7, 2021 in response to questions raised at the January 5, 2021 remote MEPA consultation meeting. For purposes of clarity, this supplemental information and original filing are referred to collectively as the ENF. Additionally, clarifying information in response to CZM's comment letter was provided to the MEPA Office on January 28, 2021 and January 29, 2021. As noted above, comments from CZM and MassDEP emphasize the importance of designing the project to avoid the channelization of flood pathways and maximizing efforts to infiltrate stormwater on-site to the greatest extent possible to avoid an increase in stormwater discharge onto and near Morrissey Boulevard. Comments from DCR are supportive of the

project and note that the project team at DCR will continue to work with the Proponent to finalize project design prior to construction.

Alternatives Analysis

As described in the ENF, the alternatives analysis considered a Renovation With No Grading Alternative, a Raise Grades and Infiltrate Stormwater Alternative and the Preferred Alternative as described above. The Renovation With No Grading Alternative would involve upgrading the amenities of the park including the ball fields, parking lot, emergency access drive and playground while keeping existing topographic elevations. This alternative was dismissed because although it would provide an emergency access way and upgrade the athletic fields and playground, it would not provide a dry parking area during storm events and would not alleviate existing flood pathways through the park which flood the existing parking lot and threaten the nearby residential neighborhood.

The Raise Grades and Infiltrate Stormwater Alternative would involve raising the grade of the entire park by a minimum of five feet (not just specific locations as in the Preferred Alternative) and constructing a retaining wall to protect the park and residential neighborhood during severe flood events. This Alternative also proposed to infiltrate all stormwater onsite. This scenario was deemed financially infeasible given the amount of fill required and unsuitable subsurface conditions; namely, geotechnical borings showed that subsurface conditions would not provide sufficient stability to support significant increases in grade and would limit stormwater infiltration. Additionally, as described in the ENF, the park is considered an urban fill site with clay-based soils which may contain foreign debris making infiltration of more stormwater less feasible. For these reasons, this alternative was dismissed.

The Preferred Alternative proposes raising elevations of strategic areas up to five feet to provide protection from projected flood risk scenarios in the most critical areas of the park, while making stormwater improvements to convey, collect, and treat stormwater before it leaves the site. The parking lot and emergency drive were selected as priority protection areas after analyzing current and future flood pathways. The proposed design allows other less critical park amenities to flood while protecting the highly used parking area during winter months. Additionally, one-way check valves located at key drainage structures will limit the up flow of stormwater to prevent excess water from entering the site. All collected stormwater will be treated to both City of Boston and MassDEP requirements prior to conveyance into Boston Harbor off-site.

Wetlands, Waterways and Stormwater

The project will impact approximately 265,800 sf (6.1 acres) of LSCSF. Additionally, the project may result in additional fill on jurisdictional filled tidelands and therefore may require a Chapter 91 License. The impacts are associated with the reconstruction of the ball fields, parking lot and access drive, and playground. To protect proximate wetland resource areas during construction, compost tubes and catch basin sediment protection measures will be placed around the perimeter of the work area at the interface with resource areas. The erosion controls will be monitored throughout the project and accumulated sediment will be removed. As described above, the project also includes upgrades to the stormwater management system. The Boston Conservation Commission will review the project for its consistency with the Wetlands Regulations (310 CMR 14.00) and associated performance

standards including the Stormwater Management Standards. MassDEP will review the project for its consistency with the Waterways Regulations (301 CMR 9.00).

The proposed stormwater system accommodates the first one inch of rainfall on-site and mitigates the impacts of increased impervious surface as required by the Boston Water and Sewer Commission (BWSC). However, as described in the ENF, geotechnical borings and test pits conducted in June 2020 produced findings indicating that much of the site is urban fill comprised of lean clay with peat below. As described in the ENF, these soil conditions are not suitable for infiltration beyond what is being proposed in the Preferred Alternative. The Preferred Alternative includes underground stormwater chambers that can allow infiltration. However, due to soil characteristics, there may be little or no actual infiltration taking place. Despite these limitations, the current stormwater design will provide for 60% peak discharge reduction for the 2-year storm, 35% reduction for the 10-year storm, 28% reduction for the 25-year, and 20% reduction for the 100-year storm event as compared to existing conditions. As discussed below, the project design is also intended to provide resiliency during future conditions as impacted by climate change. Comments from MassDEP and CZM emphasize the importance of infiltrating as much stormwater on-site as possible because of potential capacity problems at the Morrissey Boulevard outfall downstream of the site, to which stormwater from the park and residential neighborhood currently discharges. Additionally, comments from CZM and MassDEP note that the proposed best management practices (BMPs) for stormwater management do not treat bacteria. Therefore, the proponent should consider additional BMPs for treatment of stormwater. As described in BWSC's comment letter, the Proponent must fully investigate methods for retaining stormwater on-site before BWSC will consider a request to discharge additional stormwater to the BWSC's system.

Climate Change

Governor Baker's Executive Order 569: Establishing an Integrated Climate Change Strategy for the Commonwealth (EO 569; the Order) was issued on September 16, 2016. The Order recognizes the serious threat presented by climate change and direct Executive Branch agencies to develop and implement an integrated strategy that leverages state resources to combat climate change and prepare for its impacts. The Order seeks to ensure that Massachusetts will meet GHG emissions reduction limits established under the Global Warming Solution Act of 2008 (GWSA) and will work to prepare state government and cities and towns for the impacts of climate change. I note that the MEPA statute directs all State Agencies to consider reasonably foreseeable climate change impacts, including additional greenhouse gas emissions, and effects, such as predicted sea level rise, when issuing permits, licenses and other administrative approvals and decisions. M.G.L. c. 30, § 61.

Adaptation and Resiliency

As described in the ENF, the project is consistent with the resiliency solutions outlined in the *Coastal Resilience Solution For Dorchester*³ report published by the City in October 2020. The proposed parking lot layout and elevations will raise the new parking lot, Springdale Street and multiuse plaza up to 5 feet, utilizing lightweight fill material and stabilized with geogrid, to achieve elevations of 17.00 ft to 19.60 ft BCB. This elevation change is intended to increase the resiliency of the parking lot,

³ [https://www.boston.gov/sites/default/files/file/2020/10/Climate%20Ready%20Dorchester-Final%20Report%20\(Spreads%20for%20web\).pdf](https://www.boston.gov/sites/default/files/file/2020/10/Climate%20Ready%20Dorchester-Final%20Report%20(Spreads%20for%20web).pdf)

Springdale Street, and residential abutters. The intent of the project is to transition from existing elevations for the parking lot and access drive up to and above elevation 18.00 ft BCB which is the expected base flood elevation in 2050 for the 100-year storm, while considering existing topographical and private property limitations of surrounding abutters and accessibility requirements. All other areas of the park and the proposed amenities below elevation 18.00 ft BCB are being topographically graded to ensure improved stormwater collection, drainage, and flood recovery time. The proposed contouring and topography throughout the park will range from 0 to 1-foot of fill throughout the athletic fields and transition back to existing grades at the eastern limits of the park. As noted, the project will improve peak discharge rates for stormwater for the 2-year, 10-year, 25-year, and 100-year storms as compared to existing conditions; when considering climate change, the expected level of improvement under future conditions could be reduced (e.g., the project may see improvements for the 25-year storm, but not the 100-year storm, under future conditions). I encourage the Proponent to continue to consider climate change data and projections in designing the stormwater management system, and to size the system to ensure improvements in peak discharge rates for all storm scenarios under 2050 conditions.

As described in CZM's comment letter, the project site is already vulnerable to flooding in a 1% chance (100-year) annual storm, will be inundated during a 10% chance (10-year) annual storm with 9 inches of sea level rise (expected by 2030) and during high tide with 21 inches of sea level rise (expected by 2050, which is the proposed design life of the project). Comments from CZM note that, while elevation of the site is an important feature to address future climate conditions, the project should be aware of potential consequences of adding fill to achieve such elevations, including the possible channelization of coastal floodwaters onto and over Playstead Road in particular. This could exacerbate current conditions or create new flood conditions that nearby residences may not currently experience. In response, the Proponent submitted additional topographic analysis which indicates that the grade increases at an approximate slope of 5% up Playstead Road to where it meets Savin Hill Ave to the north. The Proponent asserts that the proposed project will result in an overall reduction in flood pathways and inundation depth for the park and residential area to the north. While the project improves current flooding conditions and will improve conditions during the 2050 100-year storm, during less frequent, more intense storm events, the narrowed flood pathway may result in channelization of floodwaters. Channelized floodwaters result in higher velocity flows which may be more structurally damaging to nearby residential properties. I strongly encourage the City to further explore opportunities to avoid flood channelization such as the incorporation of a berm along the northern side of the parking area which could potentially eliminate the flood pathway. Comments from CZM note that solid elements, such as granite block seat walls, may increase channelization and promote scour. Therefore, project should minimize the use of solid project components to the maximum extent practicable and should not inhibit public access along the Harborwalk.

Low Impact Development (LID) techniques utilized throughout the park design include minimizing disturbance to existing trees and shrubs and introducing bioretention basins where feasible with existing soil conditions. As discussed, proposed subsurface infiltration chambers located adjacent to the access drive and parking lot will hold stormwater on-site to further reduce the downstream and offsite pressures at the existing outlet culvert that runs parallel to the DCR Harborwalk and services much of the Savin Hill neighborhood.

Construction Period

All construction and demolition activities should be managed in accordance with applicable MassDEP’s regulations regarding Air Pollution Control (310 CMR 7.01, 7.09-7.10), and Solid Waste Facilities (310 CMR 16.00 and 310 CMR 19.00, including the waste ban provision at 310 CMR 19.017). The project should include measures to reduce construction period impacts (e.g., noise, dust, odor, solid waste management) and emissions of air pollutants from equipment, including anti-idling measures in accordance with the Air Quality regulations (310 CMR 7.11). I encourage the Proponent to require that its contractors use construction equipment with engines manufactured to Tier 4 federal emission standards, or select project contractors that have installed retrofit emissions control devices or vehicles that use alternative fuels to reduce emissions of volatile organic compounds (VOCs), carbon monoxide (CO) and particulate matter (PM) from diesel-powered equipment. Off-road vehicles are required to use ultra-low sulfur diesel fuel (ULSD). If oil and/or hazardous materials are found during construction, the Proponent should notify MassDEP in accordance with the Massachusetts Contingency Plan (310 CMR 40.00). All construction activities should be undertaken in compliance with the conditions of all State and local permits. I encourage the Proponent to reuse or recycle construction and demolition (C&D) debris to the maximum extent.

Conclusion

The ENF has adequately described and analyzed the project and its alternatives, and assessed its potential environmental impacts and mitigation measures. Based on review of the ENF and comments received on it, and in consultation with State Agencies I have determined that an EIR is not required.



January 29, 2021
Date

Kathleen A. Theoharides

Comments received:

- 01/19/2021 Office of Coastal Zone Management (CZM)
- 01/19/2021 Massachusetts Department of Environmental Protection (MassDEP) Northeast Regional Office (NERO)
- 01/19/2021 Department of Conservation and Recreation (DCR)
- 01/19/2021 Boston Water and Sewer Commission (BWSC)

KAT/EFF/eff

**Boston Water and
Sewer Commission**



980 Harrison Avenue
Boston, MA 02119-2540
617-989-7000

January 15, 2021

Secretary Kathleen Theoharides
Executive Office of Energy and Environmental Affairs
Attn: MEPA Office, Ms. Erin Flaherty
100 Cambridge Street, Suite 900
Boston MA 02114

Re: McConnell Playground Improvements
Environmental Notification Form

Dear Secretary Theoharides:

The Boston Water and Sewer Commission (Commission) has reviewed the Environmental Notification Form (ENF) for the proposed McConnell Playground improvements project located at Springdale Street in Dorchester. This letter provides the Commission's comments on the ENF.

The proposed project site is located on approximately six-acres of land and has three natural turf softball fields, children's playground, parking area, shade trees, an access road to the Dorchester Yacht Club and a harborwalk along the waterfront. The project proponent, Boston Parks & Recreation Department, proposes to reconstruct the softball fields, expand and upgrade the playground and improve the parking lot. Appurtenances also include Street lighting, security camera, spectator seating and stormwater management systems.

The Commission owns and maintains two 12-inch Ductile Iron Cement lined (DICL) water mains in Springdale Street and an 8-inch cast iron water main in Southview Street. The 12-inch water mains in Springdale Street were installed in 2010, one water main is served by the Commission's Southern High Pressure zone and the other is served by the Commission's Southern Low Pressure zone. The water main in Southview Street was installed in 1928, cleaned and cement lined in 1995 and is served by the Commission's Southern Low Pressure zone. Commission records also show that the DCR has an 8-inch DICL water main that extends across the site to the Dorchester Yacht Club. The water main was installed in 2000 and is served by the Commission Southern Low Pressure zone through a connection to the Commission's 8-inch water main in Denny Street. The water main in Denny Street was installed in 2000 and is a DICL pipe.



Sewers owned and maintained by the Commission are a 24-inch sewer in Springdale Street and a 12-inch sewer in Southview Street. The Commission also has sewers and drains that extend on-site including a 10-inch sewer in Bayside Road, a 96-inch by 120-inch storm drain and a 42-inch storm drain that extends from the existing parking area at the end of Denny Street to the 96-inch by 120-inch storm drain. Private sewers and storm drains on the site are a 4-inch sewer force main that serves the Dorchester Yacht Club and a 42-inch MassDot storm drain.

The ENF states that daily water demand for the proposed project is estimated to be 8,355 gallons per day (gpd) and wastewater generation are not applicable.

The Commission has the following comments regarding the ENF:

General

1. Prior to the initial phase of the site plan development, Boston Parks & Recreation Department should meet with the Commission's Design and Engineering Customer Services to review water main, sewer and storm drainage system availability and potential upgrades that could impact the development.
2. All new or relocated water mains, sewers and storm drains must be designed and constructed at Boston Parks & Recreation Department's, expense. They must be designed and constructed in conformance with the Commission's design standards, Water Distribution System and Sewer Use regulations, and Requirements for Site Plans. The site plan should include the locations of new, relocated and existing water mains, sewers and drains which serve the site, proposed service connections, water meter locations, as well as back flow prevention devices that will require inspection. A General Service Application must also be submitted to the Commission with the site plan.
3. The proponent estimates that daily sewage will be less than DEP's 15,000 gpd threshold. However, the proponent should be aware that if during the site plan permitting process it becomes apparent that wastewater flows will be 15,000 gpd or more, the Commission will invoke the requirement that the project participate in the 4 to 1 program.

The proponent should also note that the 4 to 1 requirement must be addressed 90 days before the activation of the water service.

4. The design of the project should comply with the City of Boston's Complete Streets Initiative, which requires incorporation of "green infrastructure" into street designs. Green infrastructure includes greenscapes, such as trees, shrubs, grasses and other landscape plantings, as well as rain gardens and vegetative swales, infiltration basins, and paving materials and permeable surfaces. The proponent must develop a



maintenance plan for the proposed green infrastructure. For more information on the Complete Streets Initiative see the City's website at <http://bostoncompletestreets.org/>

5. The Commission's records indicate that there may be a green infrastructure feature or stormwater mitigation structure on this site. The Commission request that the Boston Parks & Recreation Department verify the structure and indicate the structure along with its tributary area on the site plan that is submitted to the Commission. In addition, the Boston Parks & Recreation Department should submit a maintenance plan to the Engineering Customer Service Division.
6. The Commission will require Boston Parks & Recreation Department to undertake all necessary precautions to prevent damage or disruption of the existing active water and sewer and drain lines on, or adjacent to, the project site during construction. As a condition of the site plan approval, the Commission will require Boston Parks & Recreation Department to inspect the existing sewer and drain lines on site by CCTV after site construction is complete, to confirm that the lines were not damaged from construction activity.
7. It is Boston Parks & Recreation Department's responsibility to evaluate the capacity of the water, sewer and storm drain systems serving the project site to determine if the systems are adequate to meet future project demands. With the site plan, Boston Parks & Recreation Department must include a detailed capacity analysis for the water, sewer and storm drain systems serving the project site, as well as an analysis of the impacts the proposed project will have on the Commission's water, sewer and storm drainage systems.

Water

1. Boston Parks & Recreation Department must provide separate estimates of peak and continuous maximum water demand for the irrigation of landscaped areas, and other uses for the project with the site plan. Estimates should be based on full-site build-out of the proposed project. Boston Parks & Recreation Department should also provide the methodology used to estimate water demand for the proposed project.
2. Boston Parks & Recreation Department should consider outdoor landscaping which requires minimal use of water to maintain. The Commission recommends that timers, soil moisture indicators and rainfall sensors be installed as part of the in-ground sprinkler systems,
3. Boston Parks & Recreation Department is required to obtain a Hydrant Permit for use of any hydrant during the construction phase of this project. The water used from the



hydrant must be metered. Boston Parks & Recreation Department should contact the Commission's Meter Department for information on and to obtain a Hydrant Permit.

4. Boston Parks & Recreation Department will also be required to install approved backflow prevention devices on the water services for the irrigation systems. Boston Parks & Recreation Department is advised to consult with Mr. James Florentino, Manager of Engineering Code Enforcement, with regards to backflow prevention.
5. The Commission is utilizing a Fixed Radio Meter Reading System to obtain water meter readings. For new water meters, the Commission will provide a Meter Transmitter Unit (MTU) and connect the device to the meter. For information regarding the installation of MTUs, Boston Parks & Recreation Department, should contact the Commission's Meter Department.

Sewage / Drainage

1. In conjunction with the Site Plan and the General Service Application Boston Parks & Recreation Department, will be required to submit a Stormwater Pollution Prevention Plan. The plan must:
 - Identify specific best management measures for controlling erosion and preventing the discharge of sediment, contaminated stormwater or construction debris to the Commission's drainage system when construction is underway.
 - Include a site map which shows, at a minimum, existing drainage patterns and areas used for storage or treatment of contaminated soils, groundwater or stormwater, and the location of major control structures or treatment structures to be utilized during the construction.
 - Specifically identify how the project will comply with the Department of Environmental Protection's Performance Standards for Stormwater Management both during construction and after construction is complete.
2. Developers of projects involving disturbances of land of one acre or more will be required to obtain an NPDES General Permit for Construction from the Environmental Protection Agency and the Massachusetts Department of Environmental Protection. Boston Parks & Recreation Department is responsible for determining if such a permit is required and for obtaining the permit. If such a permit is required, it is required that a copy of the permit and any pollution prevention plan prepared pursuant to the permit be provided to the Commission's Engineering Services Department, prior to the commencement of construction. The pollution prevention plan submitted pursuant to a



NPDES Permit may be submitted in place of the pollution prevention plan required by the Commission provided the Plan addresses the same components identified in item 1 above.

3. The Commission encourages Boston Parks & Recreation Department, to explore additional opportunities for protecting stormwater quality on site by minimizing sanding and the use of deicing chemicals, pesticides, and fertilizers.
4. The discharge of dewatering drainage to a sanitary sewer is prohibited by the Commission. Boston Parks & Recreation Department is advised that the discharge of any dewatering drainage to the storm drainage system requires a Drainage Discharge Permit from the Commission. If the dewatering drainage is contaminated with petroleum products, Boston Parks & Recreation Department, will be required to obtain a Remediation General Permit from the Environmental Protection Agency (EPA) for the discharge.
5. Boston Parks & Recreation Department must fully investigate methods for retaining stormwater on-site before the Commission will consider a request to discharge stormwater to the Commission's system. Under no circumstances will stormwater be allowed to discharge to a sanitary sewer.
6. The Massachusetts Department of Environmental Protection (MassDEP) established Stormwater Management Standards. The standards address water quality, water quantity and recharge. In addition to Commission standards, Boston Parks & Recreation Department will be required to meet MassDEP Stormwater Management Standards.
7. Sanitary sewage must be kept separate from stormwater and separate sanitary sewer and storm drain service connections must be provided. The Commission requires that existing stormwater and sanitary sewer service connections, which are to be re-used by the proposed project, be dye tested to confirm they are connected to the appropriate system.
8. The Commission requests that Boston Parks & Recreation Department install a permanent casting stating "Don't Dump: Drains to Boston Harbor" next to any catch basin created or modified as part of this project. Boston Parks & Recreation Department should contact the Commission's Operations Division for information regarding the purchase of the castings.
9. The Commission requires installation of particle separators on all new parking lots greater than 7,500 square feet in size. If it is determined that it is not possible to infiltrate all of the runoff from the new parking lot, the Commission will require the installation of a particle separator or a standard Type 5 catch basin with an outlet tee for



the parking lot. Specifications for particle separators are provided in the Commission's requirements for Site Plans.

Thank you for the opportunity to comment on this project.

Yours truly,

John P. Sullivan, P.E.
Chief Engineer

JPS/rja

cc: C. Cook, Boston Parks & Recreation Department
K. Ronan, MWRA via e-mail
K. Pedersen, BPDA via e-mail
M. Zlody, BED via e-mail
P. Larocque, BWSC via e-mail



THE COMMONWEALTH OF MASSACHUSETTS
EXECUTIVE OFFICE OF ENERGY AND ENVIRONMENTAL AFFAIRS
OFFICE OF COASTAL ZONE MANAGEMENT
251 Causeway Street, Suite 800, Boston, MA 02114-2136
(617) 626-1200 FAX: (617) 626-1240

MEMORANDUM

TO: Kathleen A. Theoharides, Secretary, EEA
ATTN: Erin Flaherty, MEPA Office
FROM: Lisa Berry Engler, Director, CZM
DATE: January 19, 2021
RE: EEA #16305, McConnell Park Improvements, Boston

The Massachusetts Office of Coastal Zone Management (CZM) has completed its review of the above-referenced Environmental Notification Form (ENF) noticed in the *Environmental Monitor* dated December 23, 2020 and offers the following comments.

Project Description

With this ENF, the City of Boston, through its Parks and Recreation Department, proposes to reconstruct an existing active recreation park adjacent to I-93 and Savin Hill Beach in Dorchester to include fully lit natural turf fields; an accessible synthetic turf field; an inclusive playground; an improved and expanded parking area with a designated emergency drive; a pedestrian plaza; a portable restroom shelter; and improved on-site stormwater management. The nearly seven-acre project site includes filled tidelands and consists entirely of land subject to coastal storm flowage, which is coincident with the extent of the flood zone associated with a 1% chance annual storm (Zone AE elevations 11 and 12), according to Federal Emergency Management Agency's (FEMA) Flood Insurance Rate Map (FIRM). Portions of the project site, including the parking lot and emergency drive, which are the priority protection areas, will be elevated by up to four feet with fill to reduce the adjacent neighborhood's vulnerability to coastal flooding. This will protect the highly used parking lot and emergency drive while allowing the less critical park areas to flood. As a result of the project, impervious area will increase by almost one quarter of an acre and 8,355 gallons of water per day will be used. The project is partly funded by a \$1-million Land and Water Conservation Fund Grant from the U.S. Department of the Interior.

Project Comments

Because the impacts of climate change are anticipated to increase and accelerate, the project site, which is already vulnerable to flooding in a 1% chance annual storm, will be inundated during a 10% chance annual storm with nine inches of sea level rise (expected by 2030) and during high tide with 21 inches of sea level rise (expected by 2050, which is the proposed design life of the project). The ENF identifies the project site's flood zones based upon the current FEMA FIRM and indicates that the project is being designed for future sea level rise, however it is not clear from the plans that the increases in sea level are incorporated into the design of the project. Based on the topographic analysis provided as part of the supplemental information package, the proposed fill and grading may result in the unintended channelization of flood waters into the Playstead Road area during major storm events, especially as sea level rises and base flood elevations increase. During permitting, the



proponent should include the projected flood zones with sea level rise based on the Boston Harbor Flood Risk Model, as shown on the [Climate Ready Boston Map Explorer](#). The proponent should also describe how the project is designed to address these potential hazards, including potential side effects resulting from fill, such as the channelization of coastal floodwaters onto and over Playstead Road in particular. FEMA's post-storm damage assessments (i.e. Mitigation Assessment Team Reports) have cited flow channelization as one of the causes of damage to buildings and infrastructure during storm events. In addition, solid elements, such as granite block seat walls, may increase channelization and promote scour. Proposed fill, grading, or solid project components should avoid and minimize adverse impacts to existing wetland resource areas on or adjacent to the project site or inhibit public access along the Harborwalk.

The proposed project includes a stormwater system that will significantly reduce peak discharges during storm events. However, the anticipated impacts of climate change in addition to sea level rise include increased precipitation and more intense coastal storms. The supplemental information provided by the consultant indicates that the current capacity of the existing outfall at Morrissey Boulevard is limited and that it is not possible to calculate at what point the proposed stormwater system will be overwhelmed by stormwater, coastal floodwater, or a combination of both. Because the proposed stormwater management for this site relies on the Morrissey Boulevard stormwater system, the proponent should consider potential alternatives, such as improvements to the proposed stormwater system and/or discharge system, in coordination with DCR and the Boston Water and Sewer commission.

The site has limited ability for stormwater recharge because of the underlying urban fill material. However, the project presents an opportunity to treat stormwater to ensure that the water conveyed into Boston Harbor, which is impaired for bacteria, is not negatively impacted. The proposed best management practices (BMPs) for stormwater management do not treat bacteria; the proponent should consider additional BMPs for treatment of stormwater.

Federal Consistency

The proposed project may be subject to CZM federal consistency review. For further information on this process, please contact Robert Boeri, Project Review Coordinator, at robert.boeri@mass.gov or visit the CZM website at <https://www.mass.gov/federal-consistency-review-program>.

LBE/ts/elh/rh

cc: Andy Backman, Director of Regional Planning, Department of Conservation & Recreation
Phil DiPietro, Environmental Engineer, MassDEP-NERO
Nicholas Moreno, Executive Director, Boston Conservation Commission
Jill Provencal, Wetlands Section Chief, MassDEP-NERO



January 12, 2021

Secretary Kathleen A. Theoharides
Executive Office of Energy and Environmental Affairs
Attn: Erin Flaherty, MEPA Office
100 Cambridge Street, Suite 900
Boston, Massachusetts 02114

Re: EOEEA #16305 McConnell Park Improvements ENF

Dear Secretary Theoharides:

The Department of Conservation and Recreation (“DCR” or “Department”) is pleased to submit the following comments in response to the Environmental Notification Form (“ENF”) submitted by Boston Parks and Recreation (the “Proponent”) for the McConnell Park Improvements (the “Project”).

As described in the ENF, the Project seeks to improve Park facilities, including reconstruction of ball fields, improvements to parking facilities, street lighting, and traffic and pedestrian circulation. Boston’s McConnell Park abuts the northern boundary of DCR’s Malibu Beach.

Integration with Malibu Beach

The Department reviewed and also authorized as landowner the Notice of Intent and a Chapter 91 submittal for the Project, because proposed the City’s work activities will occur along a boundary shared by the City of Boston and DCR. The Project team is coordinating with DCR’s Design and Engineering staff to address the integration of design elements that impact coastal resources and visitor experience. DCR supports the Project and will continue to work with the Proponent during design and construction.

Thank you for the opportunity to comment on the ENF. Project work activities within the state reservation boundaries require a DCR Construction and Access Permit. Please contact the Director of Construction & Access Permitting, Sean Casey, at sean.casey@mass.gov regarding DCR Construction and Access Permits. Questions related to integration with Malibu Beach can be directed to Ginna Johnson at ginna.johnson@mass.gov.

Sincerely,

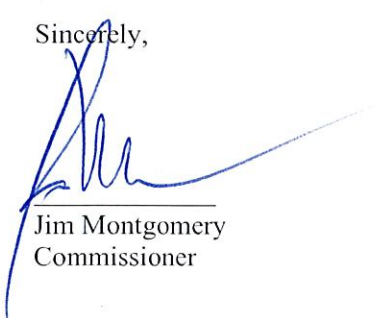

Jim Montgomery
Commissioner

Cc: Ginna Johnson, Sean Casey, Priscilla Geigis, Patrice Kish, Tom LaRosa (DCR)





Commonwealth of Massachusetts
Executive Office of Energy & Environmental Affairs

Department of Environmental Protection

Northeast Regional Office • 205B Lowell Street, Wilmington MA 01887 • 978-694-3200

Charles D. Baker
Governor

Karyn E. Polito
Lieutenant Governor

Kathleen A. Theoharides
Secretary

Martin Suuberg
Commissioner

January 19, 2021

Kathleen A. Theoharides, Secretary
Executive Office of
Energy & Environmental Affairs
100 Cambridge Street
Boston MA, 02114

RE: Boston
McConnell Park Improvements
EEA # 16305

Attn: MEPA Unit

Dear Secretary Theoharides:

The Massachusetts Department of Environmental Protection Northeast Regional Office (MassDEP-NERO) has reviewed the Environmental Notification Form (ENF) for the proposed McConnell Park Improvements in Boston. MassDEP provides the following comments.

Boston Parks and Recreation Department proposes to reconstruct McConnell Park, a park abutting Savin Hill Beach, or Savin Hill Bay basin, in the Dorchester neighborhood of Boston. The proposed project consists of the reconstruction of the existing ball fields, improvement of the parking lot, construction of a designated emergency drive, construction of a pedestrian plaza with traffic calming devices, and improvement of the tree canopy to increase shade. This project also includes improvements to on-site storm water management system.

The proposed work will impact 265,800 square feet, or approximately 6 acres, of Land Subject to Coastal Storm Flowage (LSCSF) and therefore trips the threshold for filing an ENF at 301 CMR 11.03(3)(b) f. It requires a Chapter 91 License from MassDEP and will seek funding from the U.S Department of the Interior.

Wetlands

The project proposes alteration of the entire 265,800 square feet of LSCSF, or land below elevation 11 NAVD88, at the site. Approximately 1,020 linear feet of Coastal Bank borders the

This information is available in alternate format. Contact Michelle Waters-Ekanem, Director of Diversity/Civil Rights at 617-292-5751.

TTY# MassRelay Service 1-800-439-2370

MassDEP Website: www.mass.gov/dep

Printed on Recycled Paper

site but will not be affected by the project. The site will be regraded and elevated by four feet in some areas. The ENF states that the “proposed site and stormwater design presented incorporates strategic areas of increased grade up to three feet to provide protection from projected flood risk scenarios in the most critical areas of the park, coupled with conveying, collecting, and treating stormwater before leaving the site. The parking lot and emergency drive were selected as priority protection areas after analyzing current and future flood pathways. The proposed design scenario allows other less critical park amenities to flood while protecting the highly used parking area during winter months by the neighboring residences.”

In response to comments from the review agencies during the MEPA meeting, the proponent has submitted supplemental information. This includes a narrative explaining the rationale for choosing the locations for fill, accompanied by diagrams showing how the site floods now, and showing incoming and outgoing travel paths for floodwaters, as compared to how it will flood post-construction. The proponent has also detailed the location of retaining walls located in the interior of the park and asserted that they will not adversely impact or aggravate flooding conditions at the site.

Stormwater

The project design proposes that storm water be captured by deep sump hooded catch basins or curb inlets and treated by planted bioretention basins and conveyed to underground storage chambers to minimize peak flows off-site. Check valves will be installed at downstream drainpipe locations to minimize the flow of flood waters from the ocean into the site during severe storm events. The proponent should clarify the precise extent of stormwater infiltration at the site. The ENF and the supplementary MEPA memorandum submitted January 6, 2021 state that stormwater recharge is not suitable on-site beyond what is proposed due to the soil classification and to minimize the potential for stormwater to infiltrate and leach through material containing urban fill and debris. This is supported by soil boring data showing unsuitable soils for infiltration for most of the system. The memorandum indicates that subsurface infiltration chambers will be constructed adjacent to the access drive and parking lot. It is not clear what specific subsurface chambers will function solely for storage and which will function to provide infiltration to fully to meet the stormwater standards. It is also unclear which of the subsurface chambers will be lined or unlined.

The new stormwater management system will treat and hold water before directing it to the harbor at a nearby outfall at Morrissey Boulevard. The proponent was asked to explain how the system would be limited by discharging to the Morrissey Boulevard outlet as well as the projected design functionality of the new system, or at what theoretical storm event the system will be overwhelmed and cease to function. The supplemental information contains the following response: “It is challenging to determine at what point in time or what storm event size in which the proposed McConnell Park stormwater system may become overwhelmed by ocean flooding as current stormwater calculations standards do not have the ability to consider future sea level rise or tidal flooding events. Thus, it is even more difficult to determine how stormwater and flood water from McConnell Park will impact the existing challenges at the Morrissey Boulevard outfall.” Because the final discharge of the proposed stormwater management system for this

site is the Morrissey Boulevard stormwater system, the proponent should investigate further potential improvement alternatives, such as upgrades to the proposed discharge system.

The MassDEP appreciates the opportunity to comment on this proposed project. Please contact Rachel.Freed@mass.gov at (978) 694-3258 for further information on wetlands issues. If you have any general questions regarding these comments, please contact me at John.D.Viola@mass.gov or at (978) 694-3304.

Sincerely,

This final document copy is being provided to you electronically by the Department of Environmental Protection. A signed copy of this document is on file at the DEP office listed on the letterhead.

John D. Viola
Deputy Regional Director

cc: Brona Simon, Massachusetts Historical Commission
Eric Worrall, Rachel Freed, Jill Provencal, Phil DiPietro, MassDEP-NERO

CITY OF BOSTON

THE HONORABLE MARTIN J. WALSH, MAYOR



LOCATION MAP
McCONNELL PARK
30 DENNY STREET
BOSTON, MA 02125

PREPARED BY:



85 DEVONSHIRE STREET, 3RD FLOOR
 BOSTON, MA 02109
 (617) 412-4480

PARKS AND RECREATION DEPARTMENT

RYAN WOODS, COMMISSIONER

IMPROVEMENTS TO

McCONNELL PARK

DRAWING INDEX

- L0.00 COVER SHEET
- L1.00 EXISTING CONDITIONS PLAN
- L1.01 EXISTING CONDITIONS ENLARGEMENT PLAN
- L1.02 CONSTRUCTION PHASING PLAN
- L2.00 OVERALL DEMOLITION AND SITE PREPARATION PLAN
- L2.01 DEMOLITION AND SITE PREPARATION ENLARGEMENT PLAN
- L3.00 OVERALL MATERIALS PLAN
- L3.01 - L3.03 MATERIALS ENLARGEMENT PLANS
- L3.04 TRANSPORTATION SIGNAGE PLAN
- L3.05 PARK SIGNAGE PLAN
- L4.00 OVERALL LAYOUT PLAN
- L4.01 - L4.03 LAYOUT ENLARGEMENT PLANS
- L5.00 OVERALL GRADING, DRAINAGE, AND UTILITY PLAN
- L5.01 - L5.03 GRADING, DRAINAGE, AND UTILITY ENLARGEMENT PLANS
- L6.00 OVERALL PLANTING PLAN
- L6.01 - L6.03 PLANTING ENLARGEMENT PLANS
- IR1.00 IRRIGATION PLAN
- IR2.00 IRRIGATION DETAILS
- L7.00 - L7.14 CONSTRUCTION DETAILS
- S0.01 STRUCTURAL GENERAL NOTES
- S5.01 - S5.02 ENLARGED FOUNDATION PLANS AND DETAILS
- E0.01 ELECTRICAL LEGEND, ABBREVIATIONS, AND GENERAL NOTES
- E1.00 ELECTRICAL SITE DEMOLITION PLAN
- E1.01 ELECTRICAL SITE NEW WORK PLAN
- E5.01 - E5.02 ELECTRICAL DETAILS
- E6.01 ELECTRICAL PARK & REC ONE-LINE

BOSTON, MASSACHUSETTS
FEBRUARY 3, 2021
PERMITTING DOCUMENTS
- NOT FOR CONSTRUCTION -
FUNDED BY THE CITY OF BOSTON CAPITAL
IMPROVEMENT PROGRAM
AND LAND AND WATER CONSERVATION
FUND GRANT

ADD ALTERNATE NO. 1 | 4' HT. BVCL OUTFIELD FENCE AT CHALLENGER FIELD

ADD ALTERNATE NO. 2 | DUGOUT STRUCTURE AT CHALLENGER FIELD

ADD ALTERNATE NO. 3 | METAL STORAGE CONTAINER WITH CAST-IN-PLACE CONCRETE PAD AT CHALLENGER FIELD

ADD ALTERNATE NO. 4 | SPORTS NETTING AND MOW CURB AT PARKING LOT EDGE

ADD ALTERNATE NO. 5 | SPORTS LIGHTING AND ELECTRICAL RECEPTACLE AT CHALLENGER FIELD



SURVEYOR:
FELDMAN
 LAND SURVEYORS
 152 HAMPDEN STREET
 BOSTON, MA 02119
 (617) 357-9740

Sheet No.:	L0.00
Project Name:	COVER SHEET
BPRD Project No.	CPR 24235
Date	FEBRUARY 2021
Scale	N/A
Drawn	EB, LR
Checked	CFR
Project Name:	IMPROVEMENTS TO McCONNELL PARK

GENERAL NOTES

- LOCATIONS OF ANY UTILITIES SHOWN ON THIS PLAN ARE APPROXIMATE ONLY. THE CONTRACTOR SHALL BE RESPONSIBLE FOR LOCATING AND PROTECTING ALL EXISTING UTILITIES AND REPAIRING ANY DAMAGE DONE DURING CONSTRUCTION. THE CONTRACTOR SHALL BE RESPONSIBLE FOR ALL ON-SITE COORDINATION WITH UTILITY COMPANIES AND PUBLIC AGENCIES AND FOR OBTAINING ALL REQUIRED PERMITS AND PAYING ALL REQUIRED FEES. IN ACCORDANCE WITH M.G.L. CHAPTER 82, SECTION 40, INCLUDING AMENDMENTS, CONTRACTORS SHALL NOTIFY ALL UTILITY COMPANIES AND GOVERNMENT AGENCIES IN WRITING PRIOR TO EXCAVATION. CONTRACTOR SHALL ALSO CALL "DIG SAFE" AT (881) NO LESS THAN 72 HOURS, (EXCLUSIVE OF WEEKENDS AND HOLIDAYS), PRIOR TO SUCH EXCAVATION. DOCUMENTATION OF REQUESTS SHALL BE PROVIDED TO PROJECT REPRESENTATIVE PRIOR TO EXCAVATION WORK.
- CONTRACTOR SHALL BE RESPONSIBLE FOR REVIEWING ALL DRAWINGS AND SPECIFICATIONS TO DETERMINE THE EXTENT OF EXCAVATION AND DEMOLITION REQUIRED TO RECEIVE SITE IMPROVEMENTS.
- THE CONTRACTOR SHALL BE RESPONSIBLE FOR VISITING THE SITE AND REVIEWING THE DRAWINGS AND ASSUMES RESPONSIBILITY OF VERIFYING ALL EXISTING CONDITIONS AND MATERIALS SHOWN WITHIN THE PROJECT CONTRACT LIMITS.
- ANY DISCREPANCIES OR CONFLICTS BETWEEN THE DRAWINGS AND EXISTING CONDITIONS, EXISTING CONDITIONS TO REMAIN, TEMPORARY CONSTRUCTION, PERMANENT CONSTRUCTION AND WORK OF ADJACENT CONTRACTS SHALL BE BROUGHT TO THE ATTENTION OF THE OWNER BEFORE PROCEEDING. ITEMS ENCOUNTERED IN AREAS OF EXCAVATION THAT ARE NOT INDICATED ON THE DRAWINGS, BUT ARE VISIBLE ON SURFACE, SHALL BE THE CONTRACTOR'S RESPONSIBILITY AND SHALL BE REMOVED AT NO ADDITIONAL COST TO THE OWNER.
- ANY ALTERATIONS TO THESE DRAWINGS MADE IN THE FIELD DURING CONSTRUCTION SHALL BE RECORDED BY THE GENERAL CONTRACTOR ON "AS-BUILT" DRAWINGS.
- ALL AREAS DISTURBED BY THE CONTRACTOR'S OPERATIONS OUTSIDE THE PROJECT LIMITS, SHALL BE RESTORED TO THE ORIGINAL CONDITION BY THE CONTRACTOR AT NO ADDITIONAL COST TO AND TO THE SATISFACTION OF THE OWNER.
- THE CONTRACTOR SHALL TAKE ALL NECESSARY PRECAUTIONS TO PROTECT HIS EMPLOYEES, AS WELL AS PUBLIC USERS FROM INJURY DURING THE ENTIRE CONSTRUCTION PERIOD USING ALL NECESSARY SAFEGUARDS, INCLUDING BUT NOT LIMITED TO, TEMPORARY WALKS, STRUCTURES, PROTECTIVE BARRIERS, COVERING, OR FENCES AS NEEDED.
- THE CONTRACTOR SHALL SUPPLY THE OWNER WITH THE NAME OF THE OSHA "COMPETENT PERSON" PRIOR TO CONSTRUCTION.
- FILLING OF EXCAVATED AREAS SHALL NOT TAKE PLACE WITHOUT THE PRESENCE OR PERMISSION OF THE OWNER.
- EXISTING TREES TO REMAIN SHALL BE PROTECTED FROM CONSTRUCTION ACTIVITIES. NO STOCKPILING OF MATERIAL, EQUIPMENT OR VEHICULAR TRAFFIC SHALL BE ALLOWED WITHIN THE DRIP LINE OF TREES TO REMAIN. NO GUYS SHALL BE ATTACHED TO ANY TREE TO REMAIN. WHEN NECESSARY OR AS DIRECTED BY THE ENGINEER, THE CONTRACTOR SHALL ERECT TEMPORARY BARRIERS FOR THE PROTECTION OF EXISTING TREES DURING CONSTRUCTION.
- NO FILLING SHALL OCCUR AROUND EXISTING TREES TO REMAIN WITHOUT THE APPROVAL OF THE OWNER OR OWNERS REPRESENTATIVE.
- ANY QUANTITIES SHOWN ON PLANS ARE FOR COMPARATIVE BIDDING PURPOSES ONLY. IT IS THE CONTRACTOR'S RESPONSIBILITY TO VISIT THE PROJECT SITE TO VERIFY ALL QUANTITIES PRIOR TO SUBMITTING BID.
- THE LAYOUT OF ALL NEW WALKWAYS AND THE GRADING OF ALL SLOPES AND CROSS SLOPES SHALL CONFORM TO THE COMMONWEALTH OF MASSACHUSETTS RULES AND REGULATIONS FOR HANDICAP ACCESS CMR 521, AND THE AMERICANS WITH DISABILITIES ACT (ADA), TITLE 3. THE CONTRACTOR SHALL NOTIFY THE OWNER IMMEDIATELY OF ANY DISCREPANCIES BETWEEN ACTUAL CONDITIONS AND THOSE REQUIRED.
- ALL EXISTING DRAINAGE FACILITIES TO REMAIN SHALL BE MAINTAINED FREE OF DEBRIS, SOIL, SEDIMENT, AND FOREIGN MATERIAL AND OPERATIONAL THROUGHOUT THE LIFE OF THE CONTRACT. REMOVE ALL SOIL, SEDIMENT, DEBRIS AND FOREIGN MATERIAL FROM ALL DRAINAGE STRUCTURES, INCLUDING BUT NOT LIMITED TO, DRAINAGE INLETS, MANHOLES AND CATCH BASINS WITHIN THE LIMIT OF WORK AND DRAINAGE STRUCTURES OUTSIDE THE LIMIT OF WORK THAT ARE IMPACTED BY THE WORK FOR THE ENTIRE DURATION OF CONSTRUCTION.
- CONTRACTOR'S STAGING AREA MUST BE WITHIN THE CONTRACT LIMIT LINE. ANY OTHER AREAS THAT THE CONTRACTOR MAY WISH TO USE FOR STAGING MUST BE COORDINATED WITH THE OWNER.
- CONTRACTOR SHALL COORDINATE ALL WORK WITH THE CITY OF BOSTON'S PARKS DEPARTMENT. CONTRACTOR SHALL OBTAIN CONSTRUCTION LICENSE AS REQUIRED FOR ANY WORK ON DEPARTMENT OF RECREATION AND CONSERVATION PROPERTY.
- ELEVATIONS REFER TO BOSTON CITY BASE (BCB).

LEGEND

- LIMIT OF WORK
 - PROPERTY LINE
 - LAND SUBJECT TO COASTAL STORM FLOWAGE - ZONE AE
 - 100' COASTAL BUFFER
 - 25' COASTAL BUFFER
 - ENLARGEMENT PLAN
-
- SEWER MANHOLE
 - DRAIN MANHOLE
 - ELECTRIC MANHOLE
 - WATER MANHOLE
 - MANHOLE
 - HYDRANT
 - WATER SHUT OFF/WATER GATE
 - GAS SHUT OFF/GAS GATE
 - BOSTON WATER VALVE
 - CATCH BASIN
 - D-FRAME CATCH BASIN
 - GUY WIRE
 - UTILITY POLE
 - LIGHT POLE
 - ELECTRIC HANDHOLE
 - BOLLARD
 - POST
 - SIGN
 - FLAG POLE
 - ELECTRIC METER
 - TRASH RECEPTACLE
 - DECIDUOUS TREE
 - GATE POST
 - CURB RETURN
-
- BITUMINOUS
 - BOTTOM ELEVATION
 - BOTTOM OF WALL
 - TOP OF WALL
 - CONCRETE CURB
 - CHAIN LINK FENCE
 - CONCRETE
 - DELTA ANGLE
 - INVERT ELEVATION
 - INACCESSIBLE
 - ARC LENGTH
 - NO VISIBLE PIPES
 - PICKET FENCE
 - RADIUS OR RIM ELEVATION
 - SQUARE FEET
 - TEMPORARY BENCH MARK
 - TOP OF CURB
 - TOP OF WATER
 - TOP OF TRAP
 - CENTERLINE OF TROUGH
 - TOP OF WALL
 - VERTICAL GRANITE CURB
 - WROUGHT IRON FENCE
-
- DRAIN
 - ELECTRIC
 - GAS
 - STREET LIGHTING
 - OVERHEAD WIRES
 - SEWER
 - WATER
 - METAL FENCE
 - WROUGHT IRON FENCE
 - GUARD RAIL

- TP-2 TEST PIT LOCATION
- B-5 BORING LOCATION
- TS-2 TOP SOIL SAMPLE LOCATION

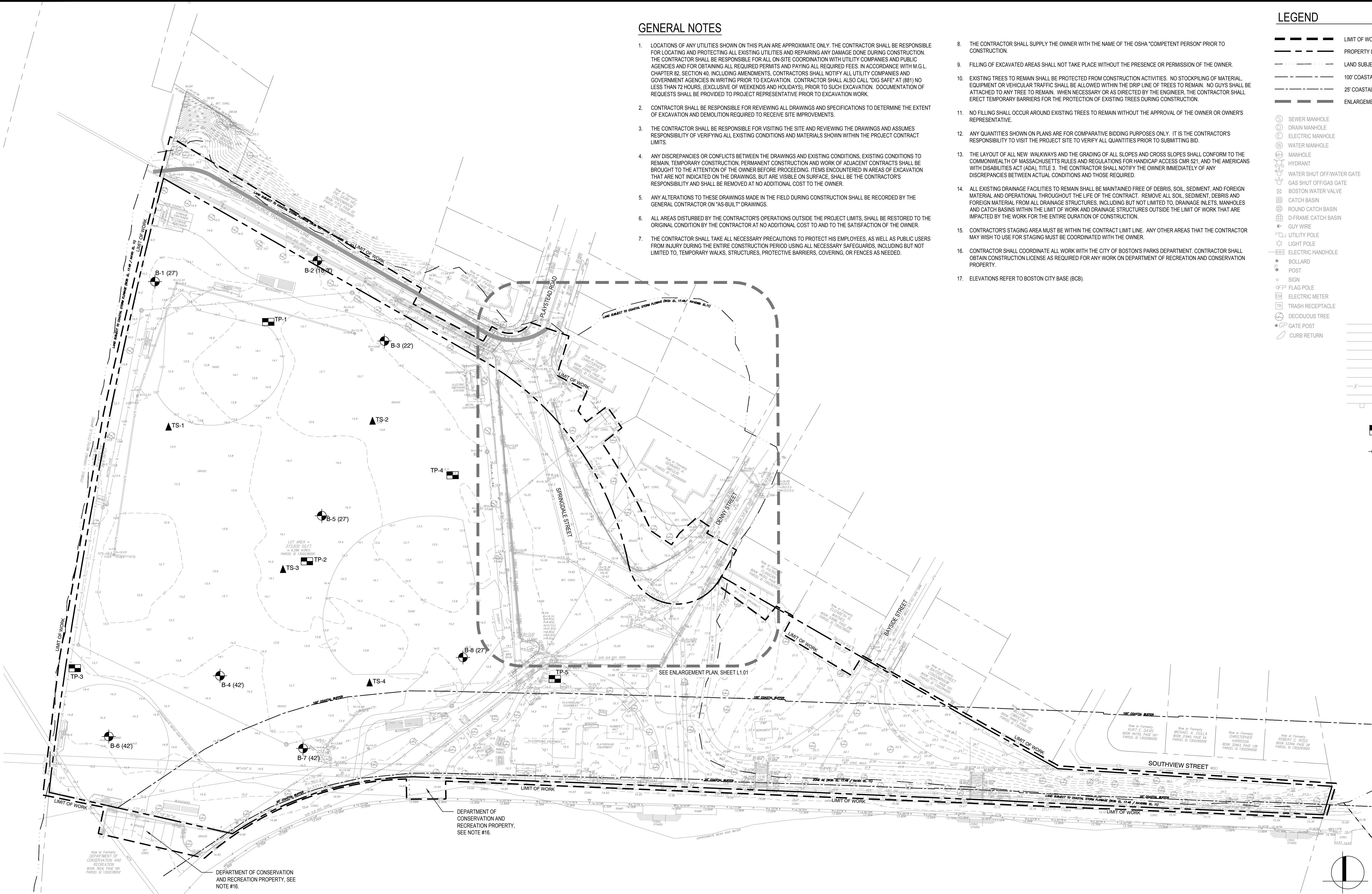

Weston & Sampson

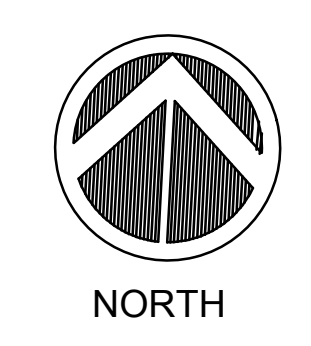

No.	Date	Revision

Approved By: _____ Date: _____

Project Name: **IMPROVEMENTS TO MCCONNELL PARK**

BWSC SUBMISSION	
Date	FEBRUARY 2021
Scale	AS SHOWN
Drawn	ENB, LSR
Checked	CFR

Sheet Name: **EXISTING CONDITIONS PLAN**

SHEET: **L1.00**

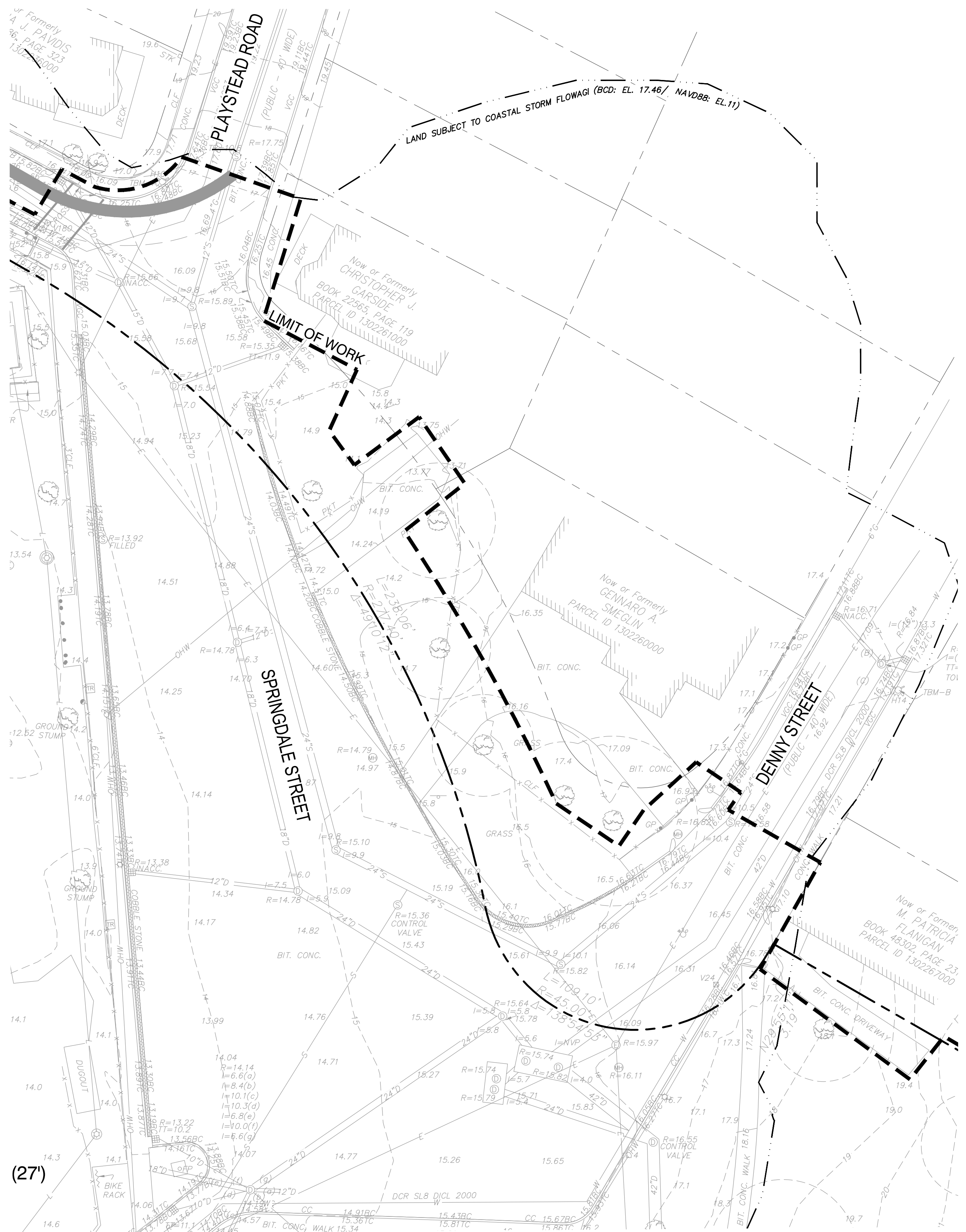

LEGEND

- | | | | |
|--|---|--|-------------------------|
| | LIMIT OF WORK | | PROPERTY LINE |
| | LAND SUBJECT TO COASTAL STORM FLOWAGE - ZONE AE | | 25' COASTAL BUFFER |
| | SEWER MANHOLE | | BIT |
| | DRAIN MANHOLE | | BITUMINOUS |
| | ELECTRIC MANHOLE | | BOT= |
| | WATER MANHOLE | | BOTTOM ELEVATION |
| | MANHOLE | | BW |
| | HYDRANT | | TOP OF WALL |
| | WATER SHUT OFF/GAS GATE | | CC |
| | GAS SHUT OFF/GAS GATE | | CONCRETE CURB |
| | BOSTON WATER VALVE | | CLF |
| | CATCH BASIN | | CHAIN LINK FENCE |
| | ROUND CATCH BASIN | | CONC |
| | D-FRAME CATCH BASIN | | CONCRETE |
| | GUY WIRE | | Δ= |
| | UTILITY POLE | | DELTA ANGLE |
| | LIGHT POLE | | /= |
| | ELECTRIC HANDHOLE | | INVERT ELEVATION |
| | BOLLARD | | INACC. |
| | POST | | L= |
| | FLAG POLE | | ARC LENGTH |
| | ELECTRIC METER | | NVP |
| | TRASH RECEPTACLE | | NO VISIBLE PIPES |
| | DECIDUOUS TREE | | PKT |
| | GATE POST | | PICKET FENCE |
| | CURB RETURN | | R= |
| | | | RADIUS OR RIM ELEVATION |
| | | | SQ. FT. |
| | | | SQUARE FEET |
| | | | TBM |
| | | | TEMPORARY BENCH MARK |
| | | | TC |
| | | | TOP OF CURB |
| | | | TOW |
| | | | TOP OF WATER |
| | | | TT= |
| | | | TOP OF TRAP |
| | | | TR= |
| | | | CENTERLINE OF TROUGH |
| | | | TW |
| | | | TOP OF WALL |
| | | | VGC |
| | | | VERTICAL GRANITE CURB |
| | | | WF |
| | | | WROUGHT IRON FENCE |
| | | | D |
| | | | DRAIN |
| | | | E |
| | | | ELECTRIC |
| | | | G |
| | | | GAS |
| | | | L |
| | | | STREET LIGHTING |
| | | | OHW |
| | | | OVERHEAD WIRES |
| | | | S |
| | | | SEWER |
| | | | W |
| | | | WATER |
| | | | X |
| | | | METAL FENCE |
| | | | X |
| | | | WROUGHT IRON FENCE |
| | | | G |
| | | | GUARD RAIL |

GENERAL NOTES

REFER TO SHEET L1.00 FOR GENERAL NOTES.

1 EMERGENCY DRIVE ENLARGEMENT PLAN
SCALE: 1" = 20'-0"

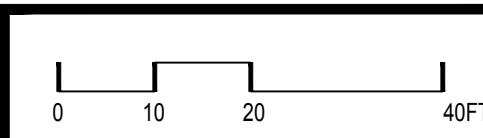
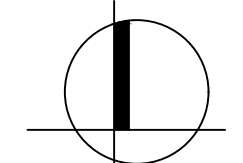

Prepared By:
Weston & Sampson
Consultant Project No. 2160850

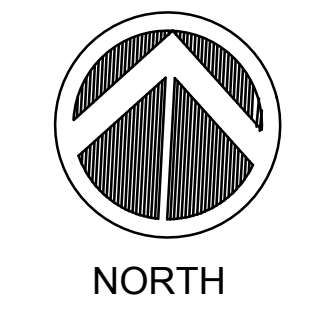

No.	Date	Revision

Approved By: _____ Date: _____

Project Name.:
**IMPROVEMENTS TO
McCONNELL PARK**

BWSC SUBMISSION
Date: FEBRUARY 2021
Scale: AS SHOWN
Drawn: ENB, LSR
Checked: CFR

Sheet Name.:
**EXISTING CONDITIONS
ENLARGEMENT PLAN**

SHEET:
L1.01

CONSTRUCTION PHASING PLAN:

1. THE WORK AREAS SHOWN ON THIS PLAN ARE THE PREFERRED BREAK-OUT OF WORK AS DETERMINED BY THE BOSTON PARKS AND RECREATION DEPARTMENT (BPRD) AND LANDSCAPE ARCHITECT (LA) AND IS BASED ON PREVIOUS PROJECT EXPERIENCE. THEY ARE IN NO PARTICULAR CHRONOLOGICAL ORDER.
2. CONTRACTOR TO SUBMIT PHASING PLAN FOR REVIEW AND DISCUSSION AND PROVIDE ONGOING UPDATES THROUGHOUT CONSTRUCTION.

PHASING PLAN SHALL INCLUDE THE FOLLOWING INFORMATION:

1. ACCESS TO DENNY STREET BY RESIDENTS FOR THE DURATION OF CONSTRUCTION.
2. ACCESS TO THEIR HOUSES FOR ALL ADJUTERS AND LITTLE TO NO DISRUPTION TO THEIR DRIVEWAYS.
3. ACCESS TO THE DORCHESTER YACHT CLUB (DYC) SHALL BE PROVIDED YEAR ROUND. ALTERNATE ROUTES DURING THE LOW SEASON CAN BE PROPOSED AND COORDINATED WITH BPRD, DYC, AND DCR (INCLUDING SUBMITTING A CONSTRUCTION ACCESS PERMIT FOR THE ACCESS). DYC HIGH SEASON: MEMORIAL DAY - LABOR DAY.
4. TEMPORARY FENCING FOR BPRD AND LA TO REVIEW AT THE PRECONSTRUCTION MEETING.
5. TIMEFRAME FOR CLOSED SIDEWALKS TO BE MINIMIZED TO THE GREATEST EXTENT POSSIBLE.
6. "PARK CLOSED" SIGNS TO BE LOCATED AT ALL ENTRANCES (SOUTHVIEW AND BAYSIDE STREETS) IN COORDINATION WITH PHASING PLAN DATES.

ACCESS PLAN SHALL INCLUDE THE FOLLOWING INFORMATION:

1. CONTRACTOR'S ACCESS PLAN SHALL MAXIMIZE TRAVEL AND MUST PROVIDE SAFE AND ACCESSIBLE ROUTES.
2. DIRECTIONAL SIGNAGE SHALL BE REQUIRED TO BE PLACED AT APPROPRIATE AREAS ON THE CONSTRUCTION FENCE AND AT OTHER LOCATIONS APPROVED BY AND COORDINATED WITH LA AND BPRD.
3. PEDESTRIAN DETOURS TO BE ADA COMPLIANT ROUTES.
4. ROUTES SHOWN DIAGRAMMATICALLY AROUND THE WORK AREAS. IT IS EXPECTED THAT THESE ROUTES REMAIN OPEN AND SAFE DURING CONSTRUCTION AND WHEN WORK AREA FENCING IS UP. ALL ROUTES AROUND AND THROUGH CONSTRUCTION WORK AREAS SHALL BE MINIMUM 5 FEET WIDTH CLEAR.
5. DURING THE COURSE OF CONSTRUCTION, WORK AREAS AND SCHEDULES ARE SUBJECT TO CHANGE BASED ON SITE CONDITIONS, UNFORESEEN CIRCUMSTANCES, AND SCHEDULED PARK ACTIVITIES, PROGRAMS, AND EVENTS. BPRD HAS MADE EVERY EFFORT TO REMOVE PERMITTED ACTIVITIES FROM THE WORK ZONE, BUT CANNOT ENSURE THAT THERE ARE NO ACTIVITIES IN THE NEIGHBORHOOD PARK VICINITY DURING THE CONSTRUCTION PERIOD INCLUDING IN ADJACENT PARKLAND (OWNED BY OTHERS) WHICH SHALL REMAIN OPEN AND ACCESSIBLE THROUGHOUT CONSTRUCTION.

6. SCHEDULING FOR ALL WORK AREAS SHALL BE COORDINATED WITH BPRD, LA, AND OTHER PROJECT STAKEHOLDERS IN ADVANCE.
7. CONTRACTOR IS OPEN TO SUGGEST ALTERNATE WORK AREA LAYOUTS THAT WILL BE SUBJECT TO REVIEW AND NEGOTIATION WITH THE BPRD, LA, AND OTHER STAKEHOLDERS IN ADVANCE.
8. CONTRACTOR'S PHASED WORK PLANS ARE TO SHOW LIMIT OF TEMPORARY CONSTRUCTION FENCING, TO BE APPROVED BY BPRD AND LA. SEE SPECIFICATIONS FOR ADDITIONAL TEMPORARY CONSTRUCTION FENCE INFORMATION.
9. ALL STAGING, STORAGE, AND OTHER AREAS USED BY CONTRACTOR DURING THE COURSE OF CONSTRUCTION SHALL BE RETURNED TO ORIGINAL CONDITION AT NO ADDITIONAL COST TO OWNER. ALL DISTURBED LAWN AREAS TO BE LOAMED AND SEEDED PER DETAILS AND SPECIFICATIONS. THERE SHALL BE ABSOLUTELY NO STAGING, STOCKPILING OF ANY MATERIAL, OR PARKING UNDER THE DRIPLINE OF ANY AND ALL TREES BOTH WITHIN AND OUTSIDE OF THE PROJECT LIMIT OF WORK.
10. SEE SPECIFICATIONS FOR ADDITIONAL PROJECT REQUIREMENTS.

PARK PEDESTRIAN ROUTE NOTES:

6. CONTRACTOR SHALL EMPLOY SPECIAL CARE AND USE SIGNAGE OR OTHER APPROPRIATE METHODS TO PROTECT SAFETY OF PEDESTRIANS INSIDE AND OUTSIDE OF CONTRACT LIMIT LINE.
7. CONTRACTOR SHALL KEEP A CLEAR, ACCESSIBLE, PEDESTRIAN ROUTE BETWEEN HARBOR WALK AND NEIGHBORHOOD AT ALL TIMES. THIS CAN BE ACCOMMODATED THROUGH MAINTAINING THE ACCESSIBLE ENTRANCE AT MORRISSEY BLVD. ANY BLOCKING OF PEDESTRIAN ROUTES SHALL BE SCHEDULED IN ADVANCE AND APPROVED BY BPRD.
8. THE CONTRACTOR SHALL PROVIDE A MATERIALS DELIVERY PLAN FOR BPRD REVIEW, INCLUDING A MAP AND DELIVERY ROUTE, TO ALL MATERIAL SUPPLIERS INDICATING PREFERRED TRUCK ROUTE AND ENTRANCE POINT TO THE SITE.
9. CONTRACTOR SHALL PREPARE A "TRAFFIC MANAGEMENT PLAN" ADDRESSING VEHICULAR AND PEDESTRIAN ROUTES. TRAFFIC MANAGEMENT PLAN TO BE SUBMITTED TO LA FOR REVIEW AND REVISED IF DIRECTED.
10. CONTRACTOR RESPONSIBLE FOR OBTAINING CONSTRUCTION ACCESS PERMIT(S) FROM THE DEPARTMENT OF RECREATION AND CONSERVATION (DCR) AND BOSTON PUBLIC WORKS DEPARTMENT (PWD).
11. CONTRACTOR, SUBCONTRACTOR, AND ALL DELIVERY VEHICLES FOR CONTRACTORS SHALL ABIDE BY THE SPEED LIMIT. ALL VEHICLES SHALL USE FLASHERS.
12. ALL CONSTRUCTION RELATED VEHICLES AND EQUIPMENT SHALL BE CLEARLY IDENTIFIED WITH COMPANY NAME.

LIMIT OF WORK NOTES:

1. PROPOSED LIMIT OF WORK FOR EACH PHASE OF WORK IS NOTED ON THE CONSTRUCTION WORK AREA SHEET. CONTRACTOR IS RESPONSIBLE FOR ALL DAMAGE DUE TO OPERATIONS INSIDE AND OUTSIDE THE CONTRACT LIMIT LINE. CONTRACTOR SHALL MEET LINE AND GRADE OF EXISTING CONDITIONS AT THE CONTRACT LIMIT LINE. SEE SPECIFICATIONS FOR REQUIREMENTS REGARDING MAINTAINING AND PROTECTING EXISTING UTILITIES INSIDE AND OUTSIDE THE CONTRACT LIMIT LINE.
2. PROJECT AREA, LIMIT OF WORK, AND FENCE ENTRY POINTS SHALL BE CLEARLY IDENTIFIED WITH SIGNS.

TEMPORARY FENCING NOTES:

1. TREE PROTECTION FENCE - SEE "DEMOLITION AND SITE PREPARATION PLANS" FOR LOCATIONS.
2. CONSTRUCTION FENCE SHALL BE TEMPORARY, MOVABLE CHAIN LINK FENCE. SEE SPECIFICATIONS.
3. IN CLOSE COORDINATION WITH BPRD AND THE LA, INSTALL CONSTRUCTION FENCING BEFORE ANY AND ALL CONSTRUCTION ACTIVITIES.
4. CONSTRUCTION FENCE SHALL BE SECURED AND MAINTAINED AT ALL TIMES TO THE SATISFACTION OF THE BPRD.
5. LAWN PROTECTION FENCE - SEE SPECIFICATIONS IF APPLICABLE.
6. CONTRACTOR RESPONSIBLE FOR REMOVAL OF ALL TEMPORARY FENCING TYPES; BPRD STAFF OR LA TO REVIEW CONDITION OF SITE PRIOR TO EACH REMOVAL. CONTRACTOR TO RESTORE GRADING AND PLANTING AT FENCE POST LOCATIONS IMMEDIATELY FOLLOWING REMOVAL.

SCHEDULING NOTES:

1. CONTRACTOR SHALL SUBMIT WEEKLY CONSTRUCTION UPDATES AND UPCOMING SCHEDULES AND WORK PLANS TO BPRD AND THE LA.

NOTE:

1. CONSTRUCTION ROUTES ARE SUBJECT TO CHANGE BASED ON SITE CONDITIONS, UNFORESEEN CIRCUMSTANCES, PARK ACTIVITIES, PROGRAMS AND EVENTS, AND ON-GOING CONSTRUCTION SCHEDULES.

LEGEND

- — — — — LIMIT OF WORK (SHOWN BY PHASE)
- — — — — PROPERTY LINE
- - - - - LAND SUBJECT TO COASTAL STORM FLOWAGE - ZONE AE
- - - - - 100' COASTAL BUFFER
- - - - - 25' COASTAL BUFFER
- SIGN

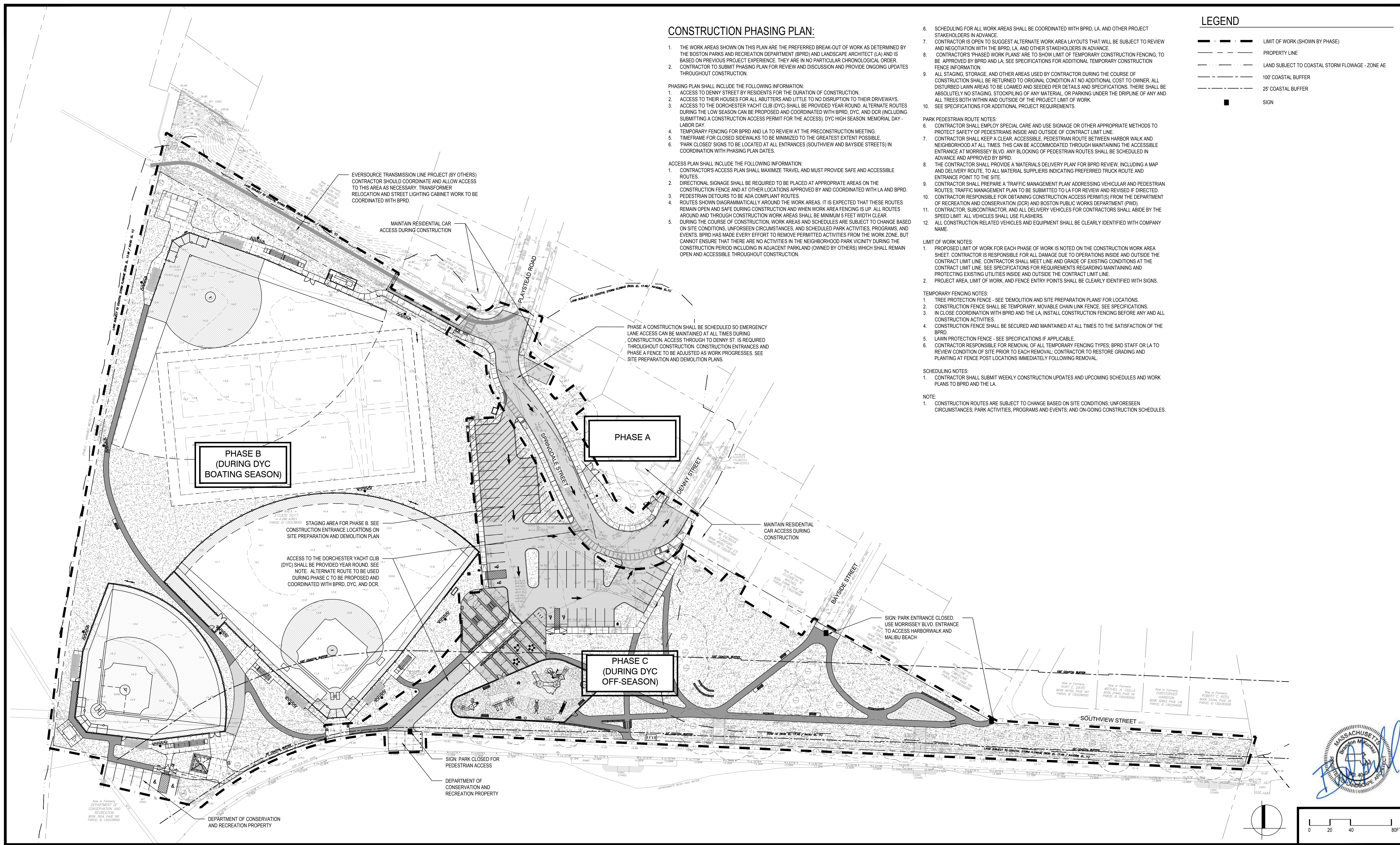

Prepared By:
 Weston & Sampson
 Consultant Project No. 2160850



No.	Date	Revision

Approved By: _____ Date: _____

Project Name.:
IMPROVEMENTS TO McCONNELL PARK

BWSC SUBMISSION
 Date: FEBRUARY 2021
 Scale: AS SHOWN
 Drawn: ENB, LSR
 Checked: CFR

Sheet Name.:
CONSTRUCTION PHASING PLAN

SHEET:
L1.02



DEMOLITION & SITE PREPARATION NOTES

- THE CONTRACTOR SHALL INCLUDE IN THE BID THE COST OF REMOVING ANY EXISTING SITE FEATURES NECESSARY TO ACCOMPLISH THE CONSTRUCTION OF THE PROPOSED SITE IMPROVEMENTS. THE CONTRACTOR SHALL ALSO INCLUDE IN THE BID THE COST NECESSARY TO RESTORE SUCH ITEMS IF THEY ARE DISTURBED YET SCHEDULED TO REMAIN AS PART OF THE FINAL SITE IMPROVEMENTS. REFER TO PLANS TO DETERMINE EXCAVATION AND DEMOLITION REQUIRED TO RECEIVE PROPOSED SITE IMPROVEMENTS AND TO DETERMINE THE LOCATION OF PROPOSED SITE IMPROVEMENTS.
- THE OWNER RESERVES THE RIGHT TO REVIEW ALL MATERIALS DESIGNATED FOR REMOVAL AND TO RETAIN OWNERSHIP OF SUCH MATERIALS. IF THE OWNER RETAINS ANY MATERIAL, THE CONTRACTOR SHALL MAKE ARRANGEMENTS WITH THE OWNER TO HAVE THOSE MATERIALS DELIVERED TO FRANKLIN PARK YARD AT NO ADDITIONAL EXPENSE TO THE OWNER.
- UNLESS SPECIFICALLY NOTED TO BE SAVED OR REUSED, ALL SITE FEATURES CALLED FOR REMOVAL SHALL BE TRANSPORTED FROM THE SITE AND DISPOSED OF IN A LAWFUL MANNER AT AN ACCEPTABLE DISPOSAL SITE AT NO COST TO THE OWNER.
- ALL EXISTING SITE FEATURES TO REMAIN SHALL BE PROTECTED THROUGHOUT THE CONSTRUCTION PERIOD. ANY FEATURES DAMAGED DURING CONSTRUCTION OPERATIONS SHALL BE REPAIRED OR REPLACED TO THE SATISFACTION OF THE OWNER AND OWNER'S REPRESENTATIVE AT NO ADDITIONAL COST TO THE OWNER.
- DURING EARTHWORK OPERATIONS, CONTRACTOR SHALL TAKE CARE TO NOT DISTURB EXISTING MATERIALS TO REMAIN, OUTSIDE THE LIMITS OF EXCAVATION AND BACKFILL AND SHALL TAKE WHATEVER MEASURES NECESSARY, AT THE CONTRACTOR'S EXPENSE, TO PREVENT ANY EXCAVATED MATERIAL FROM COLLAPSING. ALL BACKFILL MATERIALS SHALL BE PLACED AND COMPACTED AS SPECIFIED TO THE SUBGRADE REQUIRED FOR THE INSTALLATION OF THE REMAINDER OF THE CONTRACT WORK.
- ALL ITEMS CALLED FOR REMOVAL (COMPLETE) SHALL BE REMOVED TO FULL DEPTH INCLUDING ALL FOOTINGS, FOUNDATIONS, AND OTHER APPURTENANCES, EXCEPT AS SPECIFICALLY NOTED OTHERWISE.
- CONTRACTOR SHALL INSTALL TREE PROTECTION BARRIER AT DRUPLINE AFTER CLEARING UNDERBRUSH AND TAKE DUE CARE TO PREVENT INJURY TO TREES DURING CLEARING OPERATIONS. TREES TO REMAIN SHALL BE PRUNED.
- THE STORAGE OF MATERIALS AND EQUIPMENT WILL BE PERMITTED AT LOCATIONS DESIGNATED BY OWNER OR OWNER'S REPRESENTATIVE. PROTECTION OF STORED MATERIALS AND EQUIPMENT SHALL BE THE SOLE RESPONSIBILITY OF THE CONTRACTOR. THERE SHALL BE NO STORAGE OF MATERIALS OR PARKING OF CONSTRUCTION VEHICLES WITHIN DRUPLINE OF TREES.
- ALL SIGNS WITHIN LIMIT OF WORK ARE TO BE REMOVED AND STOCKPILED. SEE SIGNAGE PLAN FOR COMPLETE LIST OF SIGNS AND FUTURE PLACEMENT.
- CONTRACTOR TO COORDINATE WITH TRANSMISSION LINE INSTALLER REGARDING ACCESS AND RESTORATION OF FINISHED GRADE CONDITIONS. CONSTRUCTION ANTICIPATED TO BE IN 04 2021, BUT SUBJECT TO CHANGE.
- CONTRACTOR SHALL ADJUST ALL EXISTING MANHOLE COVERS, GATE BOX COVERS, AND ALL OTHER UNDERGROUND UTILITY ACCESS COVERS TO MATCH FINISH GRADE. SEE DETAIL 10/L7.01 FOR REQUIREMENTS FOR MANHOLE GRADE ADJUSTMENTS.

EROSION AND SEDIMENT CONTROL NOTES

- ALL SEDIMENT AND EROSION CONTROL DEVICES SHALL BE PUT INTO PLACE PRIOR TO BEGINNING ANY CONSTRUCTION OR DEMOLITION.
- THE CONTRACTOR SHALL BE RESPONSIBLE FOR THE CONTINUAL MAINTENANCE OF ALL EROSION CONTROL DEVICES THROUGHOUT THE DURATION OF THE PROJECT.
- CONTRACTOR SHALL MEET ALL OF THE COMMONWEALTH OF MASSACHUSETTS D.E.P. AND THE CITY OF BOSTON'S WETLAND ORDINANCE REGULATIONS FOR SEDIMENT AND EROSION CONTROL.
- EXCAVATED MATERIAL STOCKPILED ON THE SITE SHALL BE SURROUNDED BY A RING OF UNBROKEN SEDIMENT AND EROSION CONTROL FENCE. THE LIMITS OF ALL GRADING AND DISTURBANCE SHALL BE KEPT TO A MINIMUM WITHIN THE APPROVED AREA OF CONSTRUCTION. ALL AREAS OUTSIDE OF THE LIMIT OF CONTRACT SHALL REMAIN TOTALLY UNDISTURBED UNLESS OTHERWISE APPROVED BY OWNER'S REPRESENTATIVE.
- ALL CATCH BASINS AND DRAIN GRATES WITHIN LIMIT OF CONTRACT SHALL BE PROTECTED WITH FILTER FABRIC DURING THE ENTIRE DURATION OF CONSTRUCTION.
- ANY AREA OUTSIDE THE PROJECT LIMIT THAT IS DISTURBED SHALL BE RESTORED TO ITS ORIGINAL CONDITION AT NO COST TO THE OWNER.
- THE CONTRACTOR SHALL PROVIDE DUST CONTROL FOR CONSTRUCTION OPERATIONS AS APPROVED BY THE OWNER'S REPRESENTATIVE.
- ALL POINTS OF CONSTRUCTION EGRESS OR INGRESS SHALL BE MAINTAINED TO PREVENT TRACKING OR FLOWING OF SEDIMENT ONTO PUBLIC/Private ROADS.

NOTES:

- CONTRACTOR SHALL PROVIDE 6' HT. CONSTRUCTION FENCE PLACED AT LIMIT OF WORK OR USE EXISTING FENCE IN PLACE UNTIL CONTRACTOR HAS TO REMOVE AND DISPOSE OF IT AS INDICATED ON PLANS IF FENCE IS GREATER THAN 6' HT. CONTRACTOR IS RESPONSIBLE FOR SECURING THE SITE AT ALL TIMES FOR THE DURATION OF THE CONSTRUCTION PERIOD.
- CONTRACTOR MUST NOTIFY OWNER AND CITY OF BOSTON DEPARTMENT OF PUBLIC WORKS OF ANY WORK TO BE COMPLETED WITHIN THE RIGHT OF WAY FORTY-EIGHT HOURS PRIOR TO COMMENCING WORK.
- CONTRACTOR SHALL NOTIFY EACH ABUTTER AT LEAST 24 HOURS IN ADVANCE OF THE START OF ANY WORK THAT WILL REQUIRE THE TEMPORARY CLOSURE OF ACCESS, SUCH AS CONDUIT INSTALLATION, EXISTING PAVEMENT EXCAVATION, TEMPORARY DRIVEWAY PLACEMENT, AND SIMILAR OPERATIONS.
- CONTRACTOR SHALL COORDINATE ALL CONSTRUCTION ACTIVITIES WITHIN PUBLIC R.O.W. WITH APPROPRIATE CITY OF BOSTON OFFICIALS. SIDEWALKS SHALL REMAIN OPEN TO THE MAXIMUM EXTENT FEASIBLE. WHEN REQUIRED, PROPER SIGNAGE APPROVED BY THE OWNER SHALL BE ERRECTED TO INDICATE SIDEWALK CLOSURE AND ALTERNATE ROUTES.
- THE CONTRACTOR SHALL MAINTAIN AT LEAST ONE LANE OF TRAFFIC (11 FEET MINIMUM) ON SPRINGFIELD STREET TO AT LEAST BINDER COURSE PAVEMENT DURING THE FULL LENGTH OF CONSTRUCTION. SEE RIGHT OF WAY ENLARGEMENT AND TRAFFIC AND PEDESTRIAN CONTROL NOTES ON L2.01
- SEE CONSTRUCTION PHASING PLAN FOR ACCESS, PEDESTRIAN ROUTES, LIMITS OF WORK BY PHASE, AND TEMPORARY FENCING NOTES.
- CONTRACTOR SHALL CLEAR AND WATER, JET ALL DRAINAGE STRUCTURES AND LINES TO REMAIN WITHIN LIMIT OF WORK AND VERIFY WORKING CONDITION. REPLACE / REPAIR IF DAMAGED PER DIRECTION OF THE OWNER.
- WHERE UTILITY STRUCTURES ARE DESIGNATED TO BE REMOVED, THEY SHALL BE DEMOLISHED IN THEIR ENTIRETY OR TO A MAXIMUM OF 3' BELOW FINISHED GRADE TO ELIMINATE CONFLICT WITH PROPOSED IMPROVEMENTS.
- SEE CONSTRUCTION PHASING PLAN FOR ACCESS, PEDESTRIAN ROUTES, LIMITS OF WORK BY PHASE, AND TEMPORARY FENCING NOTES.
- THE HEAVILY TRAVELED BOSTON HARBORWALK PASSES IN FRONT OF MCCONNELL PARK. THE CONTRACTOR SHALL PROVIDE, COORDINATE, AND INSTALL ALL DETOUR COMPONENTS INCLUDING BARRIERS AND SIGNAGE. SUBJECT TO APPROVAL OF THE OWNER IN ORDER TO PROVIDE CONTINUOUS SAFE PASSAGE TO HARBORWALK USERS.
- AT DCR PROPERTY: SOIL DISTURBANCE OR FILLING, TEMPORARY OR PERMANENT, AND DISTURBANCE TO VEGETATION OR TREES SHALL BE MITIGATED THROUGHOUT THE DURATION OF CONSTRUCTION.
- AT DCR PROPERTY: CONTRACTOR SHALL RESTORE DISTURBED AREAS TO PRE-EXISTING CONDITIONS AND/OR MANAGE INVASIVE SPECIES.
- CONTRACTOR SHALL SECURE PERMITS/APPROVALS FROM THE DEPARTMENT OF CONSERVATION & RECREATION (DCR) FOR CONSTRUCTION ACCESS.

LEGEND

- LIMIT OF WORK (SHOWN BY PHASE)
- - - - - PROPERTY LINE
- - - - - LAND SUBJECT TO COASTAL STORM FLOWAGE - ZONE AE
- - - - - 100' COASTAL BUFFER
- - - - - 25' COASTAL BUFFER
- - - - - ENLARGEMENT PLAN
- [Pattern] R&D BITUMINOUS CONCRETE PAVEMENT, FULL DEPTH, COMPLETE
- [Pattern] R&D CONCRETE PAVEMENT, FULL DEPTH, COMPLETE
- [Pattern] R&D VEHICULAR BITUMINOUS CONCRETE PAVEMENT, FULL DEPTH, COMPLETE
- [Pattern] STRIP AND STOCKPILE TOPSOIL
- [Pattern] PATCH AND CLEAR AS NEEDED
- - - - - EROSION CONTROL - COMPOSITE FILTER TUBE
- - - - - 6' HT. CONSTRUCTION FENCE, TYP.
- - - - - SAW CUT
- [Pattern] R&D GRANITE COBBLE
- [Pattern] R&D FENCE, COMPLETE
- [Pattern] R&D GUARDRAIL, COMPLETE
- [Pattern] R&D CURB, TYP.
- [Symbol] R&D EXISTING TREE, TYP.
- [Symbol] R&D UTILITY STRUCTURE, TYP.
- [Symbol] R&D EXISTING BENCH, TYP.
- [Symbol] R&D LIGHT FIXTURES
- [Symbol] CONSTRUCTION ENTRANCE
- [Symbol] TREE PROTECTION, TYP.
- [Symbol] CAP AND ABANDON UTILITY STRUCTURES
- [Symbol] REMOVE POST
- [Symbol] HARBORWALK DETOUR SIGN, TYP.
- [Symbol] REMOVE & DISPOSE
- [Symbol] REMOVE & SALVAGE
- [Symbol] REMOVE & RESET
- [Symbol] P&S PROTECT & SAVE

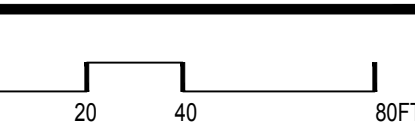
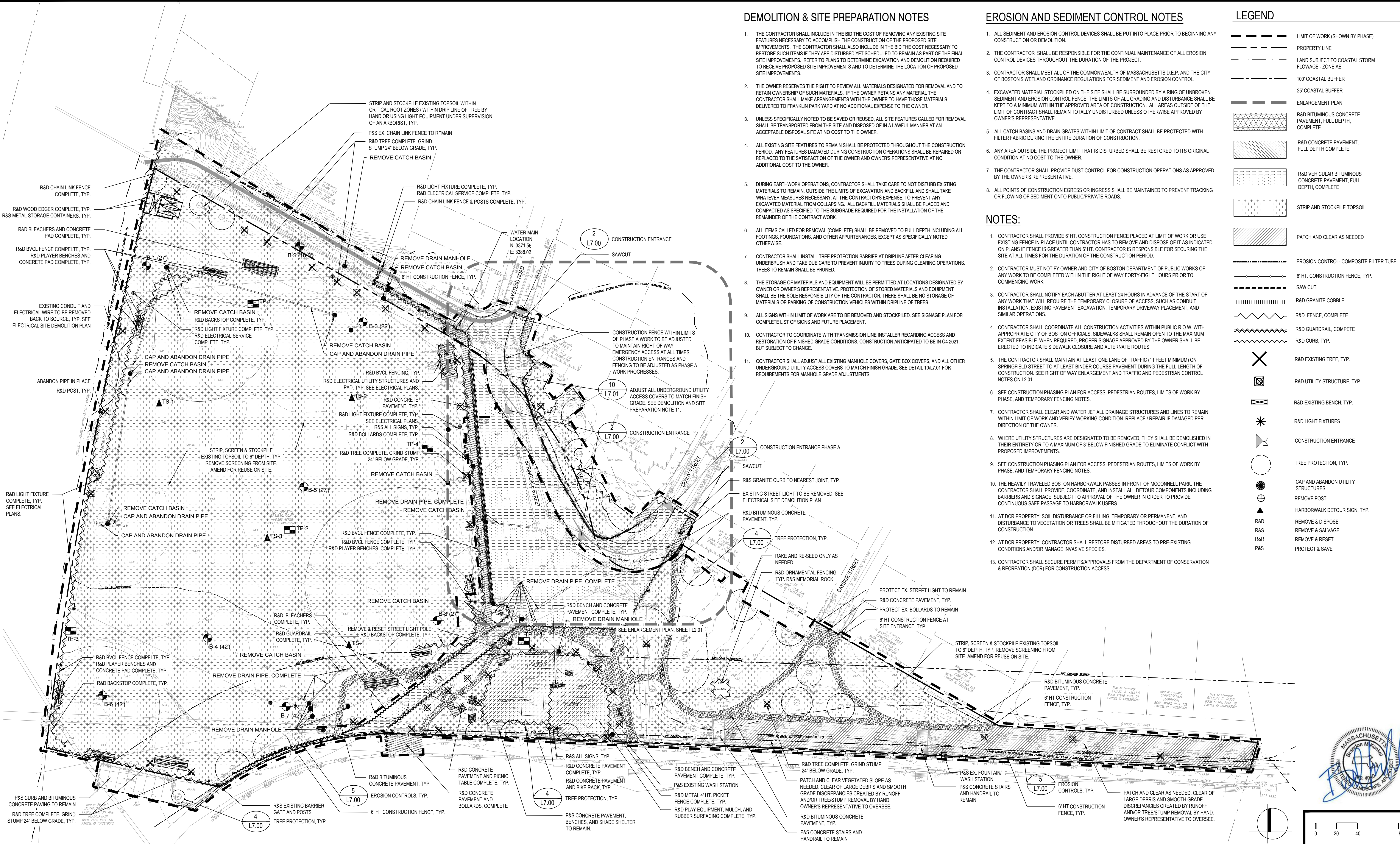

Prepared By:
 Weston & Sampson
 Consultant Project No. 2160850

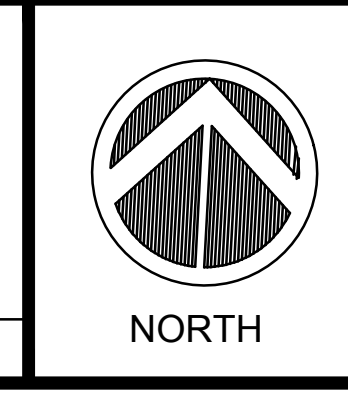

No.	Date	Revision

Approved By: _____ Date: _____

Project Name: **IMPROVEMENTS TO MCCONNELL PARK**

BWSC SUBMISSION	
Date	FEBRUARY 2021
Scale	AS SHOWN
Drawn	ENB, LSR
Checked	CFR

Sheet Name: **OVERALL DEMOLITION AND SITE PREPARATION PLAN**

SHEET: **L2.00**

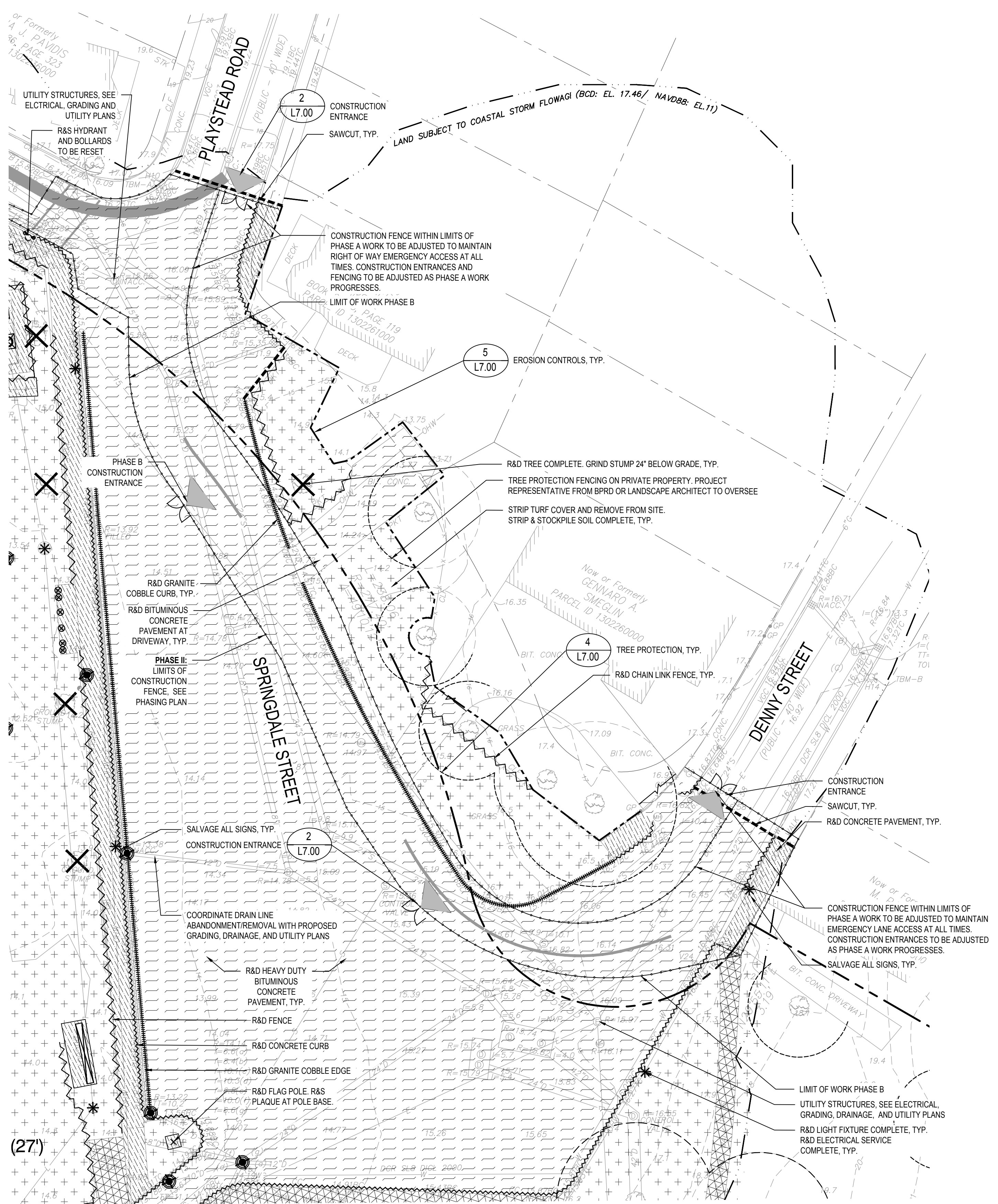

DEMOLITION & SITE PREPARATION NOTES

SEE SHEET L2.00 FOR DEMOLITION & SITE PREPARATION NOTES.

EROSION AND SEDIMENT CONTROL NOTES

SEE SHEET L2.00 FOR EROSION AND SEDIMENT CONTROL NOTES.

NOTES:

SEE SHEET L2.00 FOR NOTES.

TRAFFIC AND PEDESTRIAN CONTROL NOTES:

- TO KEEP SIDEWALKS OPEN TO THE MAXIMUM EXTENT AND MAINTAIN AT LEAST ONE LANE OF TRAFFIC ON SPRINGFIELD STREET TO AT LEAST BINDER COURSE DURING THE FULL LENGTH OF CONSTRUCTION, CONTRACTOR SHALL USE PROPER SIGNAGE, BARRIERS, AND DETOURS. SEE NOTES BELOW FOR TEMPORARY TRAFFIC AND PEDESTRIAN CONTROL.
- CONTRACTOR SHALL MAINTAIN ADA-COMPLIANT PEDESTRIAN ACCESS AT ALL TIMES, SPECIFICALLY INCLUDING PEDESTRIAN GUIDANCE SYSTEMS AT WORK ZONES. ACCESS SHALL BE MAINTAINED ALONG ALL SIDEWALKS AND CROSSWALKS, AND TO ALL ABUTTERS. ANY PEDESTRIAN DETOURS SHALL INCLUDE A FULLY ADA-COMPLIANT PEDESTRIAN DETOUR ROUTE WITH PROPER BARRICADES, RAILINGS, RAMPS, AND SIGNAGE.
- MAXIMUM SPACING OF TRAFFIC DEVICES IN A TAPER (DRUMS AND CONES) IS EQUAL IN FEET TO THE POSTED SPEED LIMIT IN MILES PER HOUR.
- ALL SIGNS SHALL BE MOUNTED ON SUITABLE TEMPORARY SUPPORTS SUCH THAT SIGNS ARE CLEARLY VISIBLE TO APPROACHING TRAFFIC.
- MAINTAIN ACCESS TO ALL DRIVEWAYS AND PEDESTRIAN SIDEWALKS AT ALL TIMES, UNLESS OTHERWISE NOTED.
- ALL TRAFFIC CONTROL DEVICES AND WORK ZONE SET-UPS ARE TO BE IN ACCORDANCE WITH MASSDOT AND MUTCD STANDARDS.

LEGEND

- LIMIT OF WORK
- PROPERTY LINE
- LAND SUBJECT TO COASTAL STORM FLOWAGE - ZONE AE
- 100' COASTAL BUFFER
- R&D BITUMINOUS CONCRETE PAVEMENT, FULL DEPTH, COMPLETE
- R&D CONCRETE PAVEMENT, FULL DEPTH COMPLETE.
- R&D VEHICULAR BITUMINOUS CONCRETE PAVEMENT, FULL DEPTH, COMPLETE
- STRIP AND STOCKPILE TOPSOIL
- PATCH AND CLEAR AS NEEDED
- EROSION CONTROL- COMPOSITE FILTER TUBE
- 6' HT. CONSTRUCTION FENCE, TYP.
- SAW CUT
- R&D GRANITE COBBLE
- R&D FENCE, COMPLETE
- R&D GUARDRAIL, COMPETE
- R&D CURB, TYP.
- R&D EXISTING TREE, TYP.
- R&D UTILITY STRUCTURE, TYP.
- R&D EXISTING BENCH, TYP.
- R&D LIGHT FIXTURES
- CONSTRUCTION ENTRANCE
- TREE PROTECTION, TYP.
- CAP AND ABANDON UTILITY STRUCTURES
- REMOVE POST
- HARBORWALK DETOUR SIGN, TYP.
- R&D REMOVE & DISPOSE
- R&S REMOVE & SALVAGE
- R&R REMOVE & RESET
- P&S PROTECT & SAVE

1 EMERGENCY DRIVE ENLARGEMENT PLAN
SCALE: 1" = 20'-0"

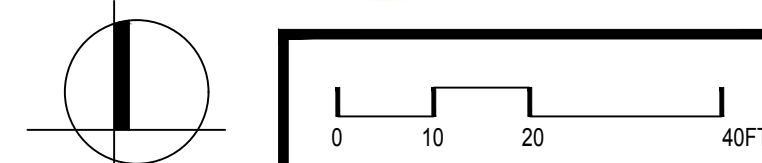

Prepared By:
Weston & Sampson
Consultant Project No. 2160850

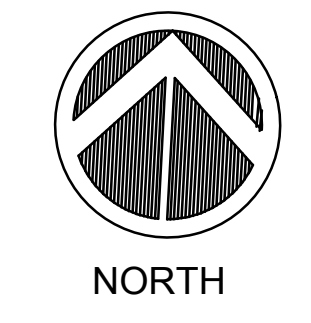

No.	Date	Revision

Approved By: _____ Date: _____

Project Name.:
IMPROVEMENTS TO McCONNELL PARK

BWSC SUBMISSION	
Date	FEBRUARY 2021
Scale	AS SHOWN
Drawn	ENB, LSR
Checked	CFR

Sheet Name.:
DEMOLITION AND SITE PREPARATION ENLARGEMENT PLAN

SHEET:
L2.01

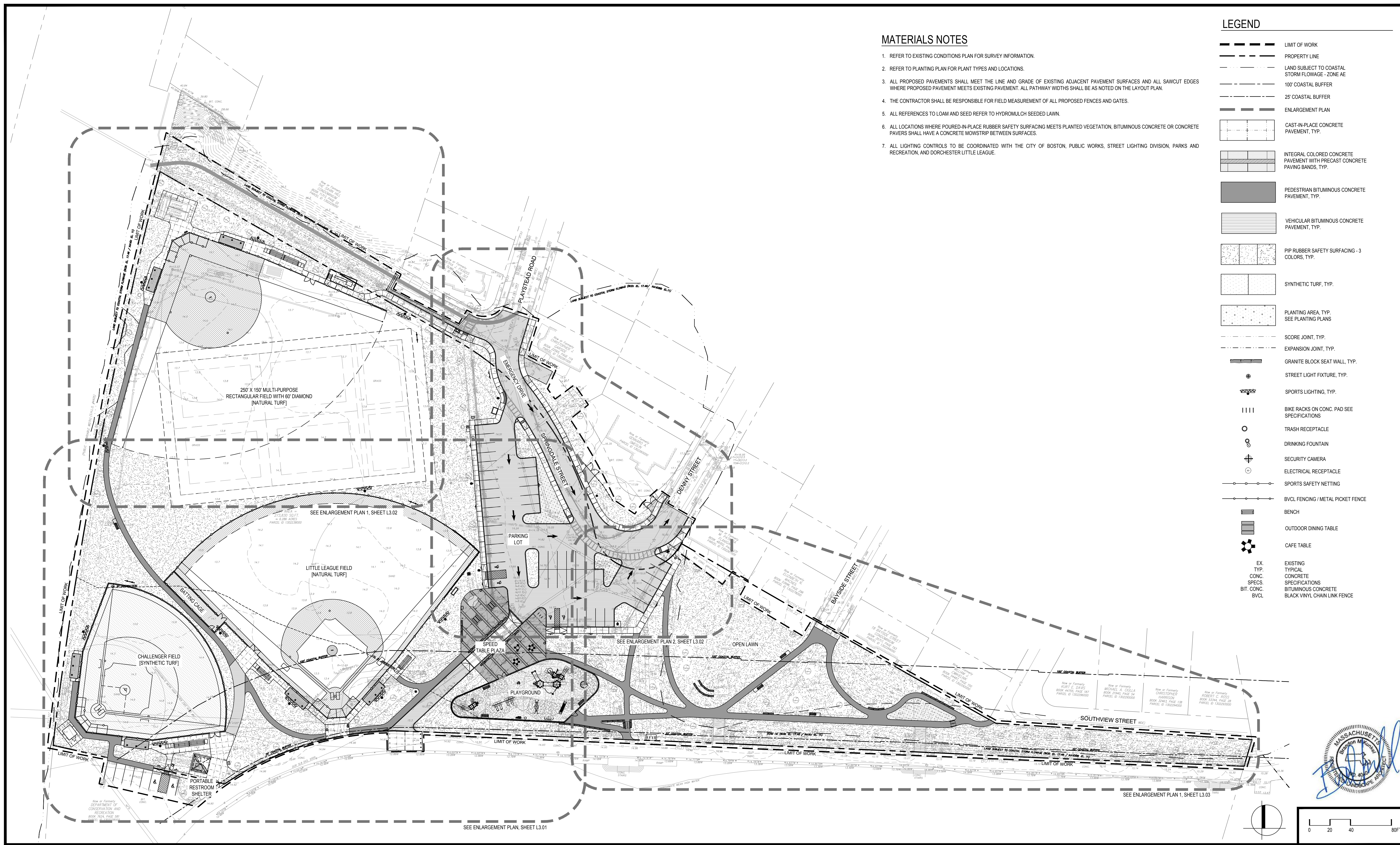

MATERIALS NOTES

1. REFER TO EXISTING CONDITIONS PLAN FOR SURVEY INFORMATION.
2. REFER TO PLANTING PLAN FOR PLANT TYPES AND LOCATIONS.
3. ALL PROPOSED PAVEMENTS SHALL MEET THE LINE AND GRADE OF EXISTING ADJACENT PAVEMENT SURFACES AND ALL SAWCUT EDGES WHERE PROPOSED PAVEMENT MEETS EXISTING PAVEMENT. ALL PATHWAY WIDTHS SHALL BE AS NOTED ON THE LAYOUT PLAN.
4. THE CONTRACTOR SHALL BE RESPONSIBLE FOR FIELD MEASUREMENT OF ALL PROPOSED FENCES AND GATES.
5. ALL REFERENCES TO LOAM AND SEED REFER TO HYDOMULCH SEEDED LAWN.
6. ALL LOCATIONS WHERE POURED-IN-PLACE RUBBER SAFETY SURFACING MEETS PLANTED VEGETATION, BITUMINOUS CONCRETE OR CONCRETE PAVERS SHALL HAVE A CONCRETE MOWSTRIP BETWEEN SURFACES.
7. ALL LIGHTING CONTROLS TO BE COORDINATED WITH THE CITY OF BOSTON, PUBLIC WORKS, STREET LIGHTING DIVISION, PARKS AND RECREATION, AND DORCHESTER LITTLE LEAGUE.

LEGEND

- LIMIT OF WORK
- PROPERTY LINE
- LAND SUBJECT TO COASTAL STORM FLOWAGE - ZONE AE
- 100' COASTAL BUFFER
- 25' COASTAL BUFFER
- ENLARGEMENT PLAN
- CAST-IN-PLACE CONCRETE PAVEMENT, TYP.
- INTEGRAL COLORED CONCRETE PAVEMENT WITH PRECAST CONCRETE PAVING BANDS, TYP.
- PEDESTRIAN BITUMINOUS CONCRETE PAVEMENT, TYP.
- VEHICULAR BITUMINOUS CONCRETE PAVEMENT, TYP.
- PIP RUBBER SAFETY SURFACING - 3 COLORS, TYP.
- SYNTHETIC TURF, TYP.
- PLANTING AREA, TYP. SEE PLANTING PLANS
- SCORE JOINT, TYP.
- EXPANSION JOINT, TYP.
- GRANITE BLOCK SEAT WALL, TYP.
- STREET LIGHT FIXTURE, TYP.
- SPORTS LIGHTING, TYP.
- BIKE RACKS ON CONC. PAD SEE SPECIFICATIONS
- TRASH RECEPTACLE
- DRINKING FOUNTAIN
- SECURITY CAMERA
- ELECTRICAL RECEPTACLE
- SPORTS SAFETY NETTING
- BVCL FENCING / METAL PICKET FENCE
- BENCH
- OUTDOOR DINING TABLE
- CAFE TABLE
- EX. TYP. CONCRETE SPECIFS. BIT. CONC. BVCL
- EXISTING TYPICAL CONCRETE SPECIFICATIONS BITUMINOUS CONCRETE BLACK VINYL CHAIN LINK FENCE



Prepared By:
 Weston & Sampson
 Consultant Project No. 2160850

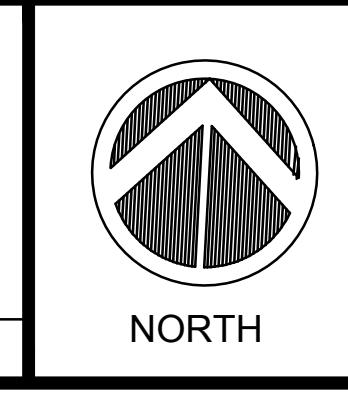

No.	Date	Revision

Approved By: _____ Date: _____

Project Name.:
IMPROVEMENTS TO MCCONNELL PARK

BWSC SUBMISSION
 Date: FEBRUARY 2021
 Scale: AS SHOWN
 Drawn: ENB, LSR
 Checked: CFR

Sheet Name.:
OVERALL MATERIALS PLAN

SHEET:
L3.00

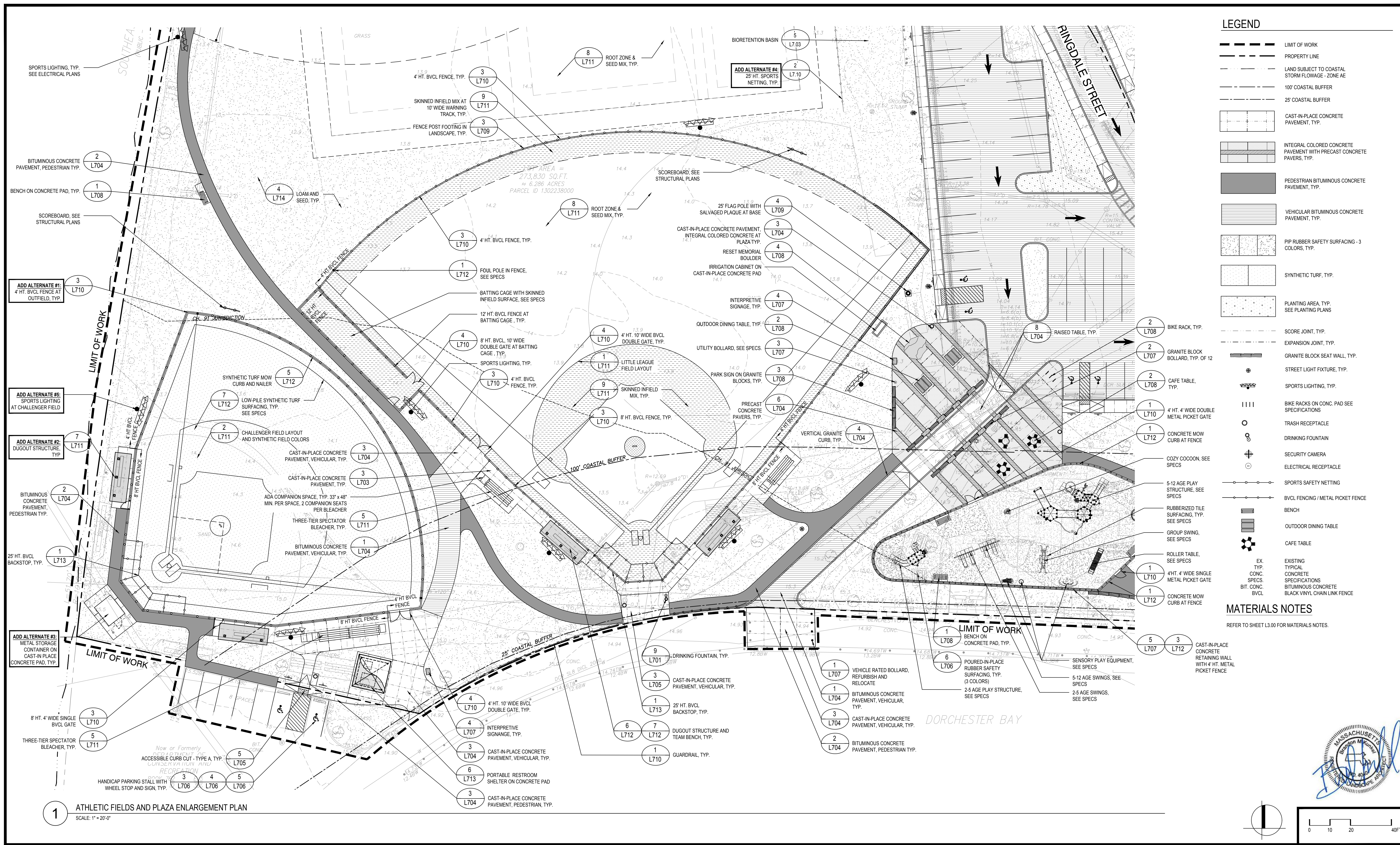

- ### LEGEND
- LIMIT OF WORK
 - PROPERTY LINE
 - LAND SUBJECT TO COASTAL STORM FLOWAGE - ZONE AE
 - 100' COASTAL BUFFER
 - 25' COASTAL BUFFER
 - CAST-IN-PLACE CONCRETE PAVEMENT, TYP.
 - INTEGRAL COLORED CONCRETE PAVEMENT WITH PRECAST CONCRETE PAVERS, TYP.
 - PEDESTRIAN BITUMINOUS CONCRETE PAVEMENT, TYP.
 - VEHICULAR BITUMINOUS CONCRETE PAVEMENT, TYP.
 - PIP RUBBER SAFETY SURFACING - 3 COLORS, TYP.
 - SYNTHETIC TURF, TYP.
 - PLANTING AREA, TYP. SEE PLANTING PLANS
 - SCORE JOINT, TYP.
 - EXPANSION JOINT, TYP.
 - GRANITE BLOCK SEAT WALL, TYP.
 - STREET LIGHT FIXTURE, TYP.
 - SPORTS LIGHTING, TYP.
 - BIKE RACKS ON CONC. PAD SEE SPECIFICATIONS
 - TRASH RECEPTACLE
 - DRINKING FOUNTAIN
 - SECURITY CAMERA
 - ELECTRICAL RECEPTACLE
 - SPORTS SAFETY NETTING
 - BVCL FENCING / METAL PICKET FENCE
 - BENCH
 - OUTDOOR DINING TABLE
 - CAFE TABLE
 - EX. TYP. CONCRETE SPECIFICATIONS
 - BIT. CONC. BITUMINOUS CONCRETE
 - BVCL. BLACK VINYL CHAIN LINK FENCE

MATERIALS NOTES

REFER TO SHEET L3.00 FOR MATERIALS NOTES.

1 ATHLETIC FIELDS AND PLAZA ENLARGEMENT PLAN
SCALE: 1" = 20'-0"

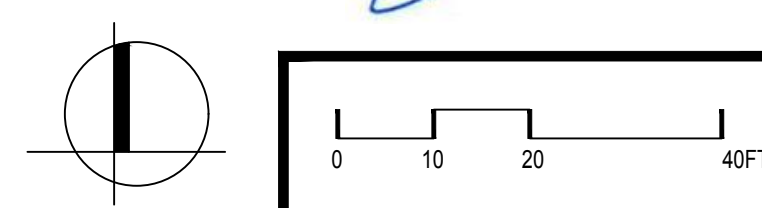

	Prepared By:		No.	Date	Revision	Project Name:	IMPROVEMENTS TO McCONNELL PARK	BWS SUBMISSION Date: FEBRUARY 2021 Scale: AS SHOWN Drawn: ENB, LSR Checked: CFR	Sheet Name:	MATERIALS ENLARGEMENT PLAN	SHEET:	L3.01
	Consultant Project No.: 2160850		Approved By:	Date:								

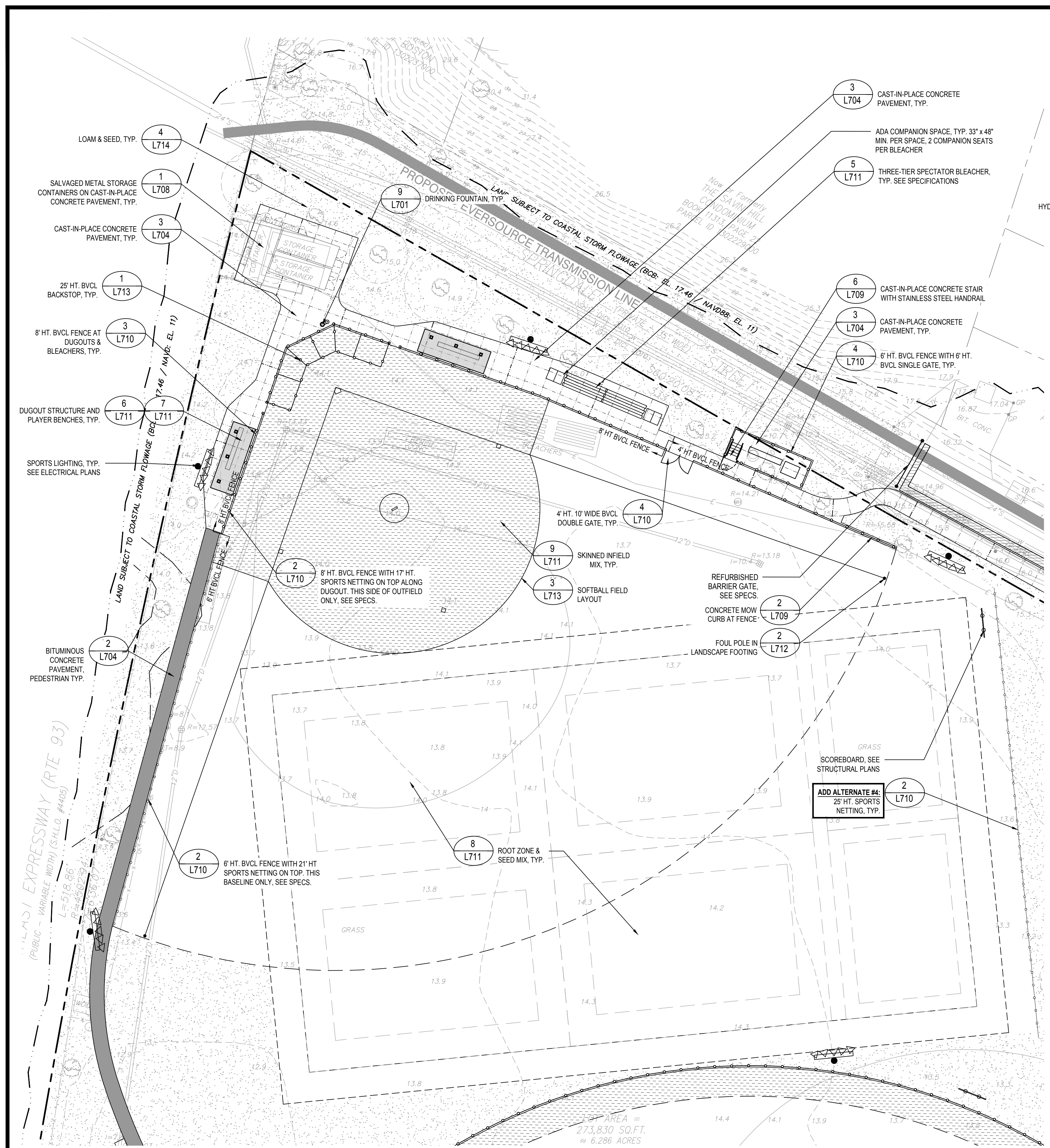

1 MULTI-USE FIELD ENLARGEMENT PLAN
SCALE: 1" = 20'-0"

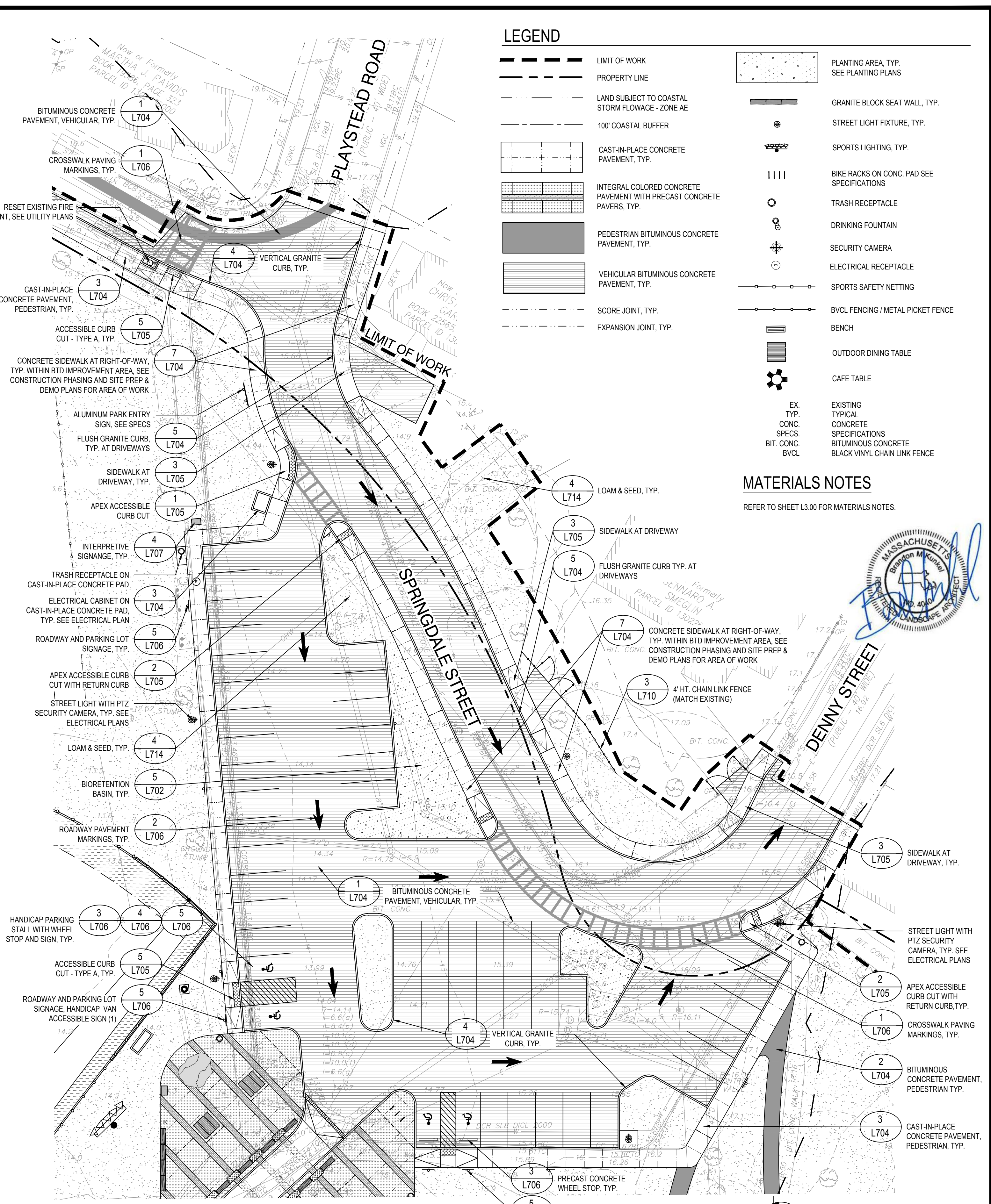

2 EMERGENCY DRIVE ENLARGEMENT PLAN
SCALE: 1" = 20'-0"

LEGEND

	LIMIT OF WORK		PLANTING AREA, TYP. SEE PLANTING PLANS
	PROPERTY LINE		GRANITE BLOCK SEAT WALL, TYP.
	LAND SUBJECT TO COASTAL STORM FLOWAGE - ZONE AE		STREET LIGHT FIXTURE, TYP.
	100' COASTAL BUFFER		SPORTS LIGHTING, TYP.
	CAST-IN-PLACE CONCRETE PAVEMENT, TYP.		BIKE RACKS ON CONC. PAD SEE SPECIFICATIONS
	INTEGRAL COLORED CONCRETE PAVEMENT WITH PRECAST CONCRETE PAVERS, TYP.		TRASH RECEPTACLE
	PEDESTRIAN BITUMINOUS CONCRETE PAVEMENT, TYP.		DRINKING FOUNTAIN
	VEHICULAR BITUMINOUS CONCRETE PAVEMENT, TYP.		SECURITY CAMERA
	SCORE JOINT, TYP.		ELECTRICAL RECEPTACLE
	EXPANSION JOINT, TYP.		SPORTS SAFETY NETTING
			BVCL FENCING / METAL PICKET FENCE
			BENCH
			OUTDOOR DINING TABLE
			CAFE TABLE
	EX. TYP. CONC. SPECS. BIT. CONC. BVCL		

MATERIALS NOTES
REFER TO SHEET L3.00 FOR MATERIALS NOTES.



Prepared By:
Weston & Sampson
Consultant Project No. 2160850



No.	Date	Revision

Approved By: _____ Date: _____















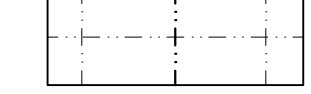

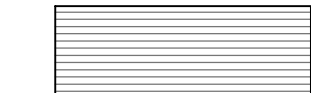



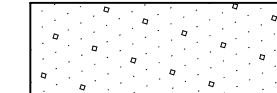



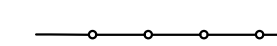

Project Name.:
IMPROVEMENTS TO MCCONNELL PARK

BWSC SUBMISSION
Date: FEBRUARY 2021
Scale: AS SHOWN
Drawn: ENB, LSR
Checked: CFR

Sheet Name.:
MATERIALS ENLARGEMENT PLAN

SHEET:
L3.02

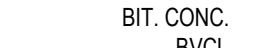
LEGEND

-  LIMIT OF WORK
-  PROPERTY LINE
-  LAND SUBJECT TO COASTAL STORM FLOWAGE - ZONE AE
-  100' COASTAL BUFFER
-  25' COASTAL BUFFER
-  CAST-IN-PLACE CONCRETE PAVEMENT, TYP.
-  PEDESTRIAN BITUMINOUS CONCRETE PAVEMENT, TYP.
-  VEHICULAR BITUMINOUS CONCRETE PAVEMENT, TYP.
-  PIP RUBBER SAFETY SURFACING - 3 COLORS, TYP.
-  SCORE JOINT, TYP.
-  EXPANSION JOINT, TYP.
-  PLANTING AREA, TYP. SEE PLANTING PLANS
-  GRANITE BLOCK SEAT WALL, TYP.
-  STREET LIGHT FIXTURE, TYP.
-  SPORTS LIGHTING, TYP.
-  BIKE RACKS ON CONC. PAD SEE SPECIFICATIONS
-  TRASH RECEPTACLE
-  DRINKING FOUNTAIN
-  SECURITY CAMERA
-  ELECTRICAL RECEPTACLE
-  BVCL FENCING / METAL PICKET FENCE
-  BENCH
-  OUTDOOR DINING TABLE
-  CAFE TABLE
-  EX. TYP.
-  TYPICAL CONCRETE SPECIFICATIONS
-  BIT. CONC. BITUMINOUS CONCRETE SPECIFICATIONS
-  BLACK VINYL CHAIN LINK FENCE

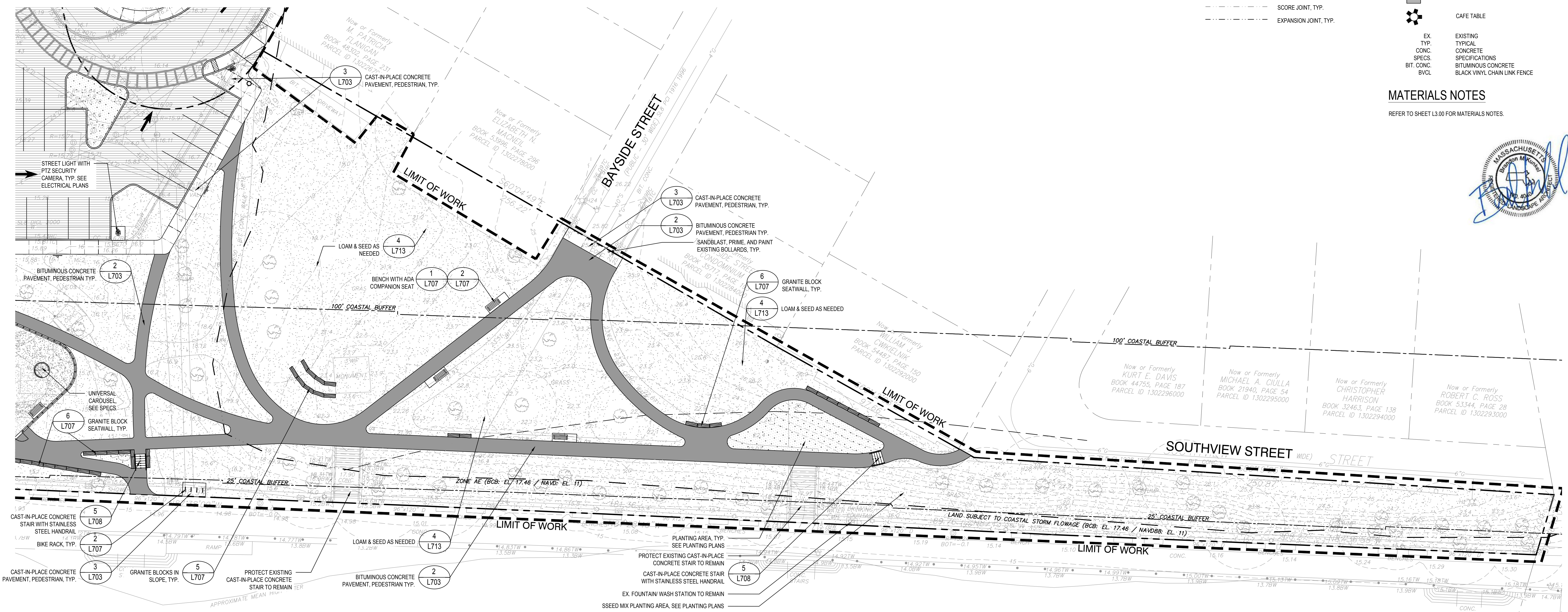

MATERIALS NOTES

REFER TO SHEET L3.00 FOR MATERIALS NOTES.

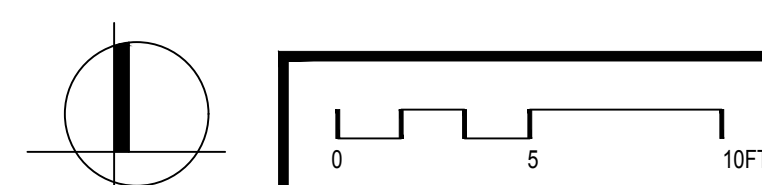

1 ENLARGEMENT PLAN
SCALE: 1" = 10'-0"



	Prepared By:		No.	Date	Revision	<p>IMPROVEMENTS TO McCONNELL PARK</p>	Date	FEBRUARY 2021	<p>SHEET: L3.03</p>	
			Approved By:				Date:	<p>BWSC SUBMISSION</p>		<p>Scale: 1" = 10'-0"</p>
								<p>Drawn: ENB, LSR</p>		
								<p>Checked: CFR</p>		

SIGNAGE NOTES - TRANSPORTATION

1. SALVAGE ALL SIGNS WITHIN LIMIT OF WORK.
2. RE-LOCATE STREET AND PARKING LOT SIGNS PER PLAN.
3. BPRD PARK SIGNAGE TO BE LOCATED AND VERIFIED IN FIELD BY OWNER'S REPRESENTATIVE.
4. ALL DCR AND MDC SIGNAGE TO BE RE-LOCATED TO A VERTICAL STRUCTURE/LIGHT POLES ALONG THE HARBORWALK.
5. ALL NEW SIGN POSTS SHALL BE BTD OR MUTCD COMPLIANT.
6. ALL SIGNS AND POSTS SHALL BE COMPLIANT WITH BTD AND/OR MUTCD SPECIFICATIONS AND DETAILS.
7. REFER TO DRAWING FOR NEW POLE LOCATIONS AND QUANTITIES.

LEGEND

- LIMIT OF WORK
- PROPERTY LINE
- LAND SUBJECT TO COASTAL STORM FLOWAGE - ZONE AE
- 100' COASTAL BUFFER
- 25' COASTAL BUFFER

SIGN SCHEDULE

BOSTON TRANSPORTATION DEPARTMENT (BTD)

BTD CODE	MUTCD	EXISTING #	NEW	SIGN	LOCATION	SIZE	NOTES
R-1	R1-1	1	2	STOP	PARKING LOT	30"x30"	
	W3-1a	1		DRIVE SLOW	PARKING LOT	30"x30"	
MA-11A		1		BOSTON OPERATION STREET SAFE DIAL 911 (BT-BP)	PARKING LOT		
PB-31		1		RESIDENT PERMIT PARKING ONLY	PLAYSTEAD	18"x18"	
S-17		1		STREET CLEANING	PLAYSTEAD	18"x18"	
R-10	R5-1	2		DO NOT ENTER	PLAYSTEAD ENTRANCE	30"x30"	
R-2	R6-1	2		ONE WAY	PLAYSTEAD ENTRANCE	36"x12"	
R-14a		2		PRIVATE DRIVE DO NOT ENTER	PARK SIDE OF PAPER STREET	18"x18"	
T-23		3		TOW ZONE NO STOPPING ANY TIME	PAPER STREET ON FENCE AND GATE	12"x18"	
T-14		3		TOW ZONE, NO STOPPING FIRE LANE	ALONG FIRE LANE	12"x18"	
W-15	W15-1	1		PLAYGROUND	AT ENTRANCE TO PARKING LOT	24"x24"	
	D9-6	3		HANDICAP PARKING	3 HANDICAP PARKING SIGNS	24"x24"	
	D9-6P	1	1	HANDICAP PARKING (VAN ACCESSIBLE)	1 IN EACH PARKING LOT - ON D9-6	18"x9"	
PB-31		8		DORCHESTER RESIDENT PERMIT PARKING (W/ DATE AND TIMES)	CROSS PARKING LOT	18"x18"	ONLY USING 5 OF EXISTING 8
AC-1		1		STREET CLEANING	TOWARD DENNY ST	18"x18"	
W-6	W17-2	2		CROSSWALK	PARKING LOT	24"x24"	
	W17-2	3		RAISED TABLE AHEAD	TOWARD DENNY ST	24"x24"	
	W17-3	4		RAISED TABLE	PARKING LOT	24"x24"	

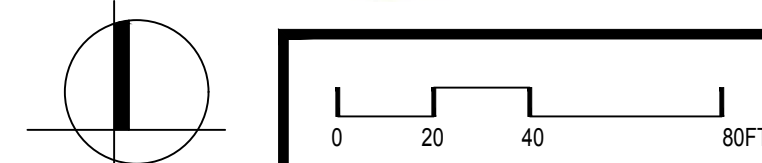
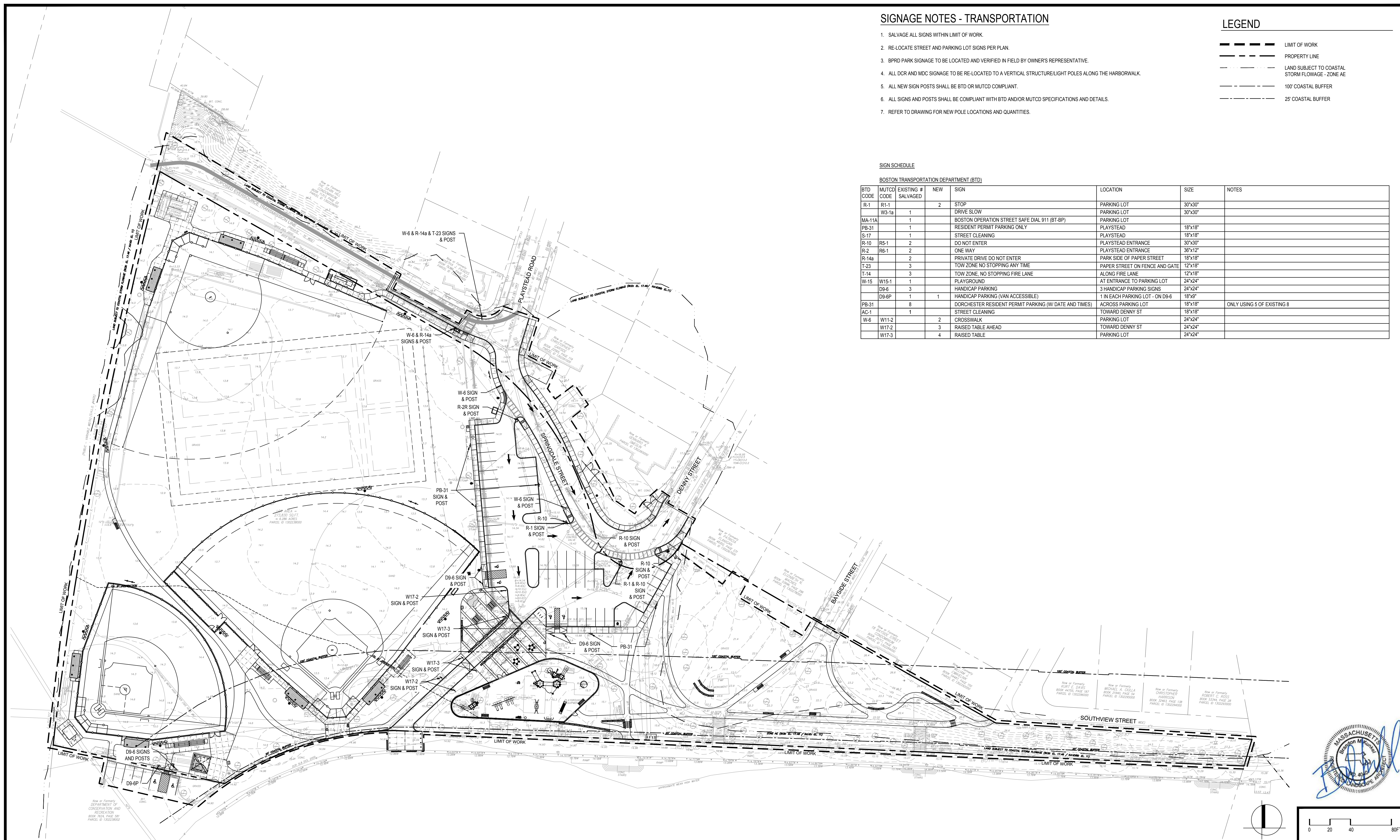

Prepared By:
 Weston & Sampson
 Consultant Project No. 2160850

No.	Date	Revision

Approved By: _____ Date: _____

Project Name.:
**IMPROVEMENTS TO
 McCONNELL PARK**

BWSC SUBMISSION
 Date: FEBRUARY 2021
 Scale: AS SHOWN
 Drawn: ENB, LSR
 Checked: CFR

Sheet Name.:
**TRANSPORTATION
 SIGNAGE PLAN**

SHEET:
L3.04

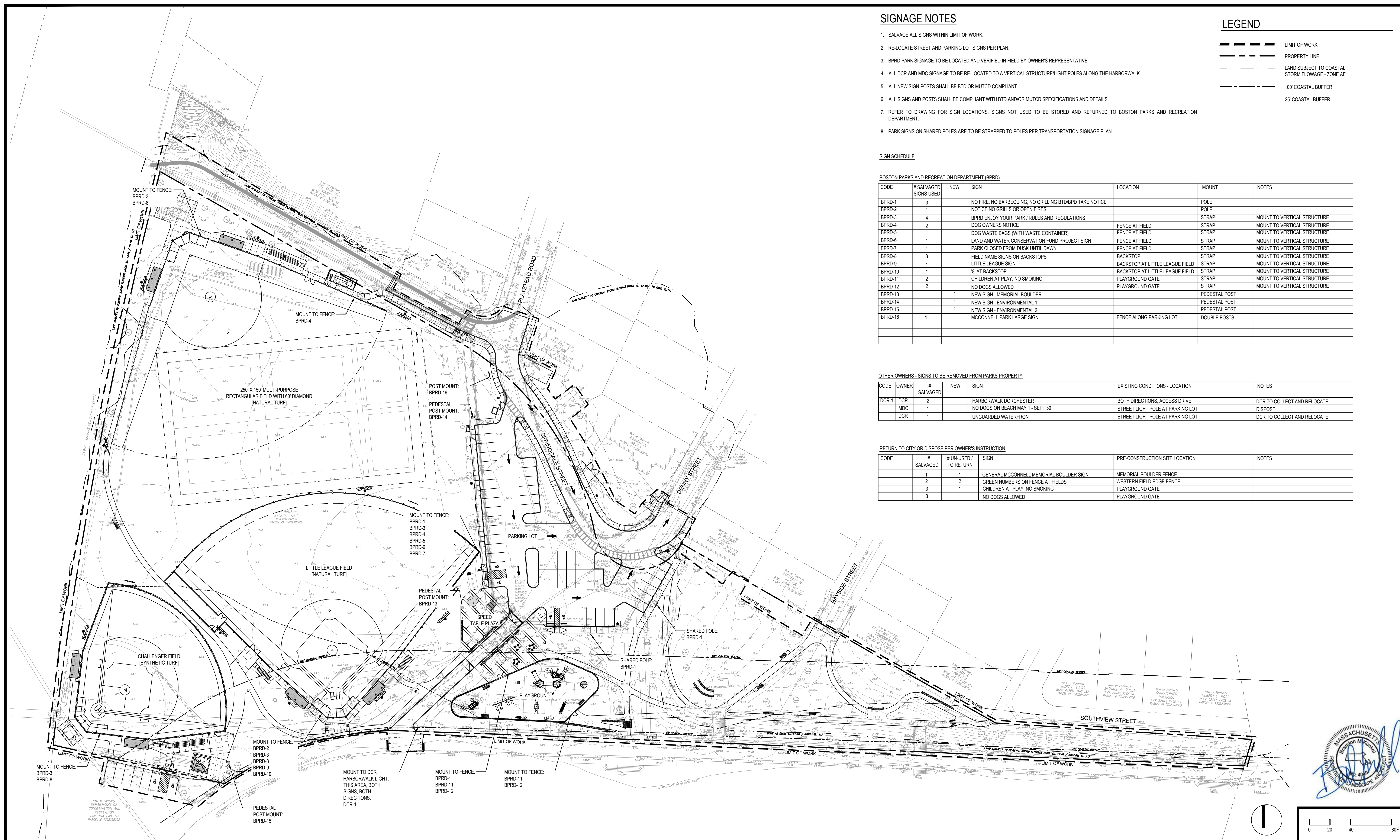

SIGNAGE NOTES

1. SALVAGE ALL SIGNS WITHIN LIMIT OF WORK.
2. RE-LOCATE STREET AND PARKING LOT SIGNS PER PLAN.
3. BPRD PARK SIGNAGE TO BE LOCATED AND VERIFIED IN FIELD BY OWNER'S REPRESENTATIVE.
4. ALL DCR AND MDC SIGNAGE TO BE RE-LOCATED TO A VERTICAL STRUCTURE/LIGHT POLES ALONG THE HARBORWALK.
5. ALL NEW SIGN POSTS SHALL BE BTD OR MUTCD COMPLIANT.
6. ALL SIGNS AND POSTS SHALL BE COMPLIANT WITH BTD AND/OR MUTCD SPECIFICATIONS AND DETAILS.
7. REFER TO DRAWING FOR SIGN LOCATIONS. SIGNS NOT USED TO BE STORED AND RETURNED TO BOSTON PARKS AND RECREATION DEPARTMENT.
8. PARK SIGNS ON SHARED POLES ARE TO BE STRAPPED TO POLES PER TRANSPORTATION SIGNAGE PLAN.

LEGEND

- LIMIT OF WORK
- PROPERTY LINE
- LAND SUBJECT TO COASTAL STORM FLOWAGE - ZONE AE
- 100' COASTAL BUFFER
- 25' COASTAL BUFFER

SIGN SCHEDULE

BOSTON PARKS AND RECREATION DEPARTMENT (BPRD)						
CODE	# SALVAGED SIGNS USED	NEW	SIGN	LOCATION	MOUNT	NOTES
BPRD-1	3		NO FIRE, NO BARBECUING, NO GRILLING BTD/BPD TAKE NOTICE		POLE	
BPRD-2	1		NOTICE NO GRILLS OR OPEN FIRES		POLE	
BPRD-3	4		BPRD ENJOY YOUR PARK / RULES AND REGULATIONS		STRAP	MOUNT TO VERTICAL STRUCTURE
BPRD-4	2		DOG OWNERS NOTICE	FENCE AT FIELD	STRAP	MOUNT TO VERTICAL STRUCTURE
BPRD-5	1		DOG WASTE BAGS (WITH WASTE CONTAINER)	FENCE AT FIELD	STRAP	MOUNT TO VERTICAL STRUCTURE
BPRD-6	1		LAND AND WATER CONSERVATION FUND PROJECT SIGN	FENCE AT FIELD	STRAP	MOUNT TO VERTICAL STRUCTURE
BPRD-7	1		PARK CLOSED FROM DUSK UNTIL DAWN	FENCE AT FIELD	STRAP	MOUNT TO VERTICAL STRUCTURE
BPRD-8	3		FIELD NAME SIGNS ON BACKSTOPS	BACKSTOP	STRAP	MOUNT TO VERTICAL STRUCTURE
BPRD-9	1		LITTLE LEAGUE SIGN	BACKSTOP AT LITTLE LEAGUE FIELD	STRAP	MOUNT TO VERTICAL STRUCTURE
BPRD-10	1		® AT BACKSTOP	BACKSTOP AT LITTLE LEAGUE FIELD	STRAP	MOUNT TO VERTICAL STRUCTURE
BPRD-11	2		CHILDREN AT PLAY, NO SMOKING	PLAYGROUND GATE	STRAP	MOUNT TO VERTICAL STRUCTURE
BPRD-12	2		NO DOGS ALLOWED	PLAYGROUND GATE	STRAP	MOUNT TO VERTICAL STRUCTURE
BPRD-13		1	NEW SIGN - MEMORIAL BOULDER		PEDESTAL POST	
BPRD-14		1	NEW SIGN - ENVIRONMENTAL 1		PEDESTAL POST	
BPRD-15		1	NEW SIGN - ENVIRONMENTAL 2		PEDESTAL POST	
BPRD-16	1		MCCONNELL PARK LARGE SIGN	FENCE ALONG PARKING LOT	DOUBLE POSTS	

OTHER OWNERS - SIGNS TO BE REMOVED FROM PARKS PROPERTY

CODE	OWNER	# SALVAGED	NEW	SIGN	EXISTING CONDITIONS - LOCATION	NOTES
DCR-1	DCR	2		HARBORWALK DORCHESTER	BOTH DIRECTIONS, ACCESS DRIVE	DCR TO COLLECT AND RELOCATE
	MDC	1		NO DOGS ON BEACH MAY 1 - SEPT 30	STREET LIGHT POLE AT PARKING LOT	DISPOSE
	DCR	1		UNGUARDED WATERFRONT	STREET LIGHT POLE AT PARKING LOT	DCR TO COLLECT AND RELOCATE

RETURN TO CITY OR DISPOSE PER OWNER'S INSTRUCTION

CODE	# SALVAGED	# UN-USED TO RETURN	SIGN	PRE-CONSTRUCTION SITE LOCATION	NOTES
	1	1	GENERAL MCCONNELL MEMORIAL BOULDER SIGN	MEMORIAL BOULDER FENCE	
	2	2	GREEN NUMBERS ON FENCE AT FIELDS	WESTERN FIELD EDGE FENCE	
	3	1	CHILDREN AT PLAY, NO SMOKING	PLAYGROUND GATE	
	3	1	NO DOGS ALLOWED	PLAYGROUND GATE	

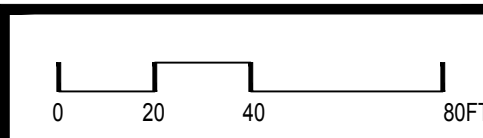

Prepared By:

 Consultant Project No. 2160850

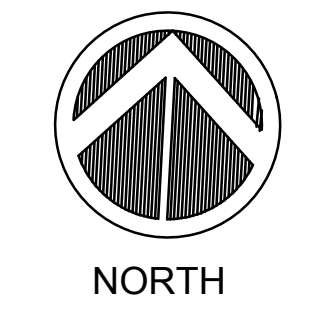

No.	Date	Revision

Approved By: _____ Date: _____

Project Name.:
IMPROVEMENTS TO MCCONNELL PARK

BWSC SUBMISSION
 Date: FEBRUARY 2021
 Scale: AS SHOWN
 Drawn: ENB, LSR
 Checked: CFR

Sheet Name.:
PARK SIGNAGE PLAN

SHEET:
L3.05

LAYOUT NOTES

- COORDINATE ALL LAYOUT ACTIVITIES WITH THE SCOPE OF WORK CALLED FOR BY DEMOLITION, GRADING AND UTILITIES OPERATIONS ENCOMPASSED BY THIS CONTRACT. SET, PROTECT AND REPLACE REFERENCE STAKES AS NECESSARY OR AS REQUIRED BY THE OWNER'S REPRESENTATIVE.
- ALL WORK SHALL BE PERFORMED BY CONTRACTOR UNLESS SPECIFICALLY INDICATED THAT THE WORK WILL BE PERFORMED BY CITY.
- THE LAYOUT OF SITE AMENITIES AND FENCES MUST BE APPROVED BY THE OWNER'S REPRESENTATIVE PRIOR TO INSTALLATION.
- ALL PROPOSED SITE FEATURES SHALL BE LAID OUT AND STAKED FOR REVIEW AND APPROVAL BY THE OWNER'S REPRESENTATIVE PRIOR TO COMMENCEMENT OF INSTALLATION. ANY REQUIRED ADJUSTMENTS TO THE LAYOUT SHALL BE UNDERTAKEN AS DIRECTED, AT NO ADDITIONAL COST TO THE OWNER.
- ALL PROPOSED PAVEMENTS SHALL MEET THE LINE AND GRADE OF EXISTING ADJACENT PAVEMENT SURFACES AND SHALL BE TREATED WITH AN RS-1 TACK COAT AT POINT OF CONNECTION. ALL PATHWAY WIDTHS SHALL BE AS NOTED ON THE LAYOUT AND MATERIALS PLAN.
- THE CONTRACTOR SHALL VERIFY ALL DIMENSIONS AND GRADES ON THE GROUND AND REPORT ANY DISCREPANCIES IMMEDIATELY TO THE OWNER.
- THE CONTRACTOR SHALL BE RESPONSIBLE FOR FIELD MEASUREMENTS OF ALL PROPOSED FENCES.
- REFER TO DETAIL DRAWINGS FOR SITE CONSTRUCTION DETAILS.

LEGEND

- LIMIT OF WORK
- PROPERTY LINE
- LAND SUBJECT TO COASTAL STORM FLOWAGE - ZONE AE
- 100' COASTAL BUFFER
- 25' COASTAL BUFFER
- ENLARGEMENT PLAN
- CENTER LINE
- 1'-3" TYP. DIMENSION
- R3' TYP. ARC DIMENSION
- 30.00° TYP. ANGLE DIMENSION

P.O.B. #8	CURVE TABLE			
CURVE #	RADIUS	LENGTH	BEGIN	END
C25	108.0	17.3	N: 3049.5517 E: 3487.5250	N: 3053.0543 E: 3470.6077
C26	160.0	54.1	N: 3017.3990 E: 3554.2147	N: 2998.1167 E: 3604.5039
C27	353.0	45.2	N: 2998.1167 E: 3604.5039	N: 2993.0877 E: 3649.4198
C28	39.5	15.4	N: 2984.3363 E: 3858.7253	N: 2987.1724 E: 3873.7662
C29	18.5	11.0	N: 2987.8856 E: 3884.5817	N: 2987.1724 E: 3873.7662

P.O.B. #8	Line Table	
Line #	Length	Direction
L16	180.832	N87° 35' 05.41"W
L17	28.656	N87° 44' 16.29"W

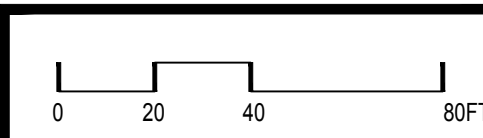
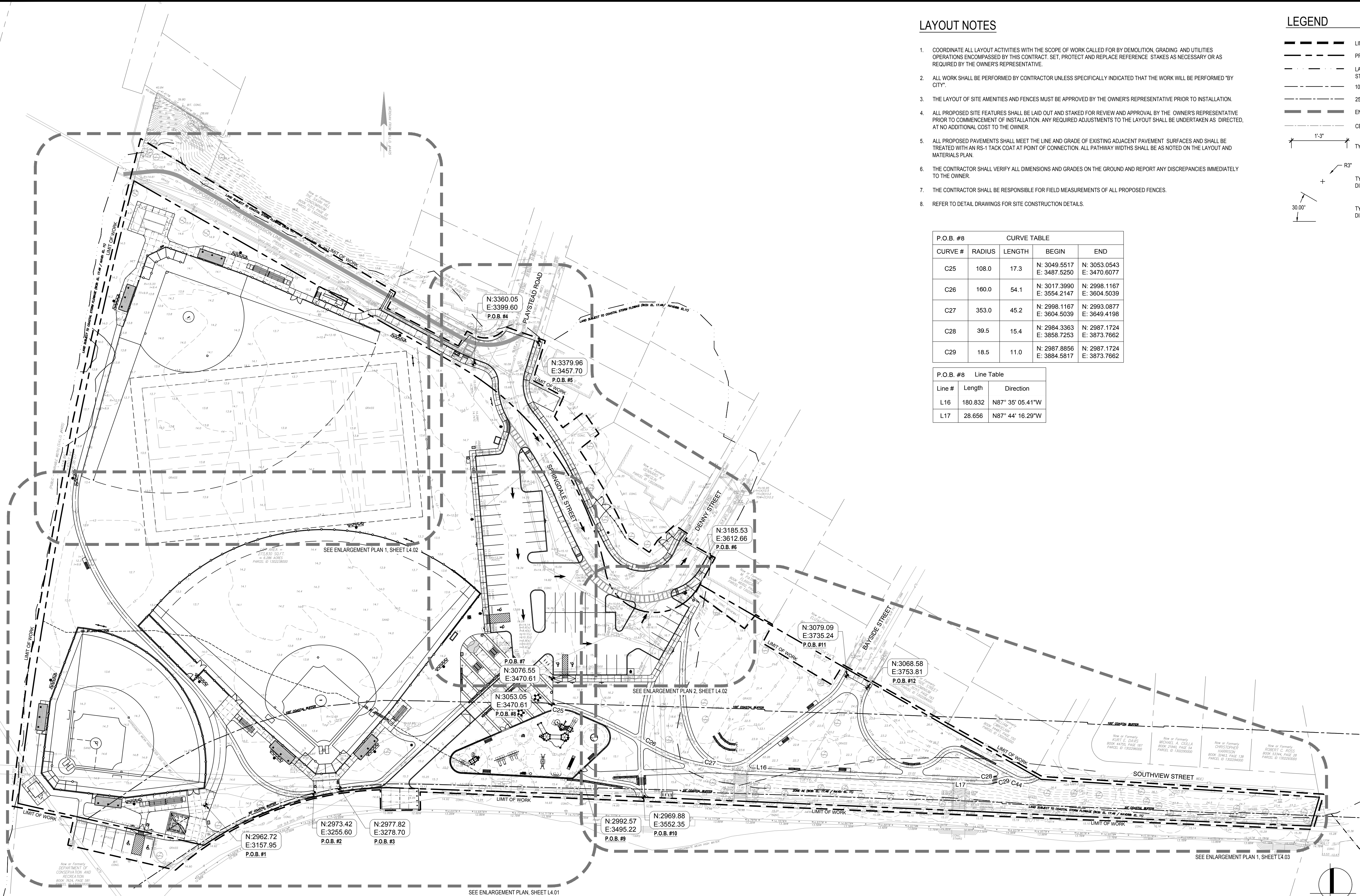

Prepared By:
 Weston & Sampson
 Consultant Project No. 2160850

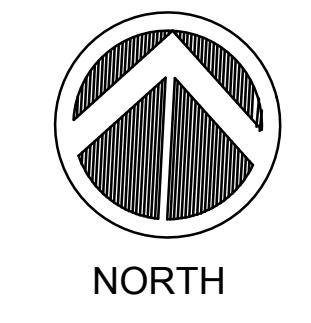

No.	Date	Revision

Approved By: _____ Date: _____

Project Name.:
**IMPROVEMENTS TO
 McCONNELL PARK**

BWSC SUBMISSION
 Date: FEBRUARY 2021
 Scale: 1" = 40'-0"
 Drawn: ENB, LSR
 Checked: CFR

Sheet Name.:
OVERALL LAYOUT PLAN

SHEET:
L4.00

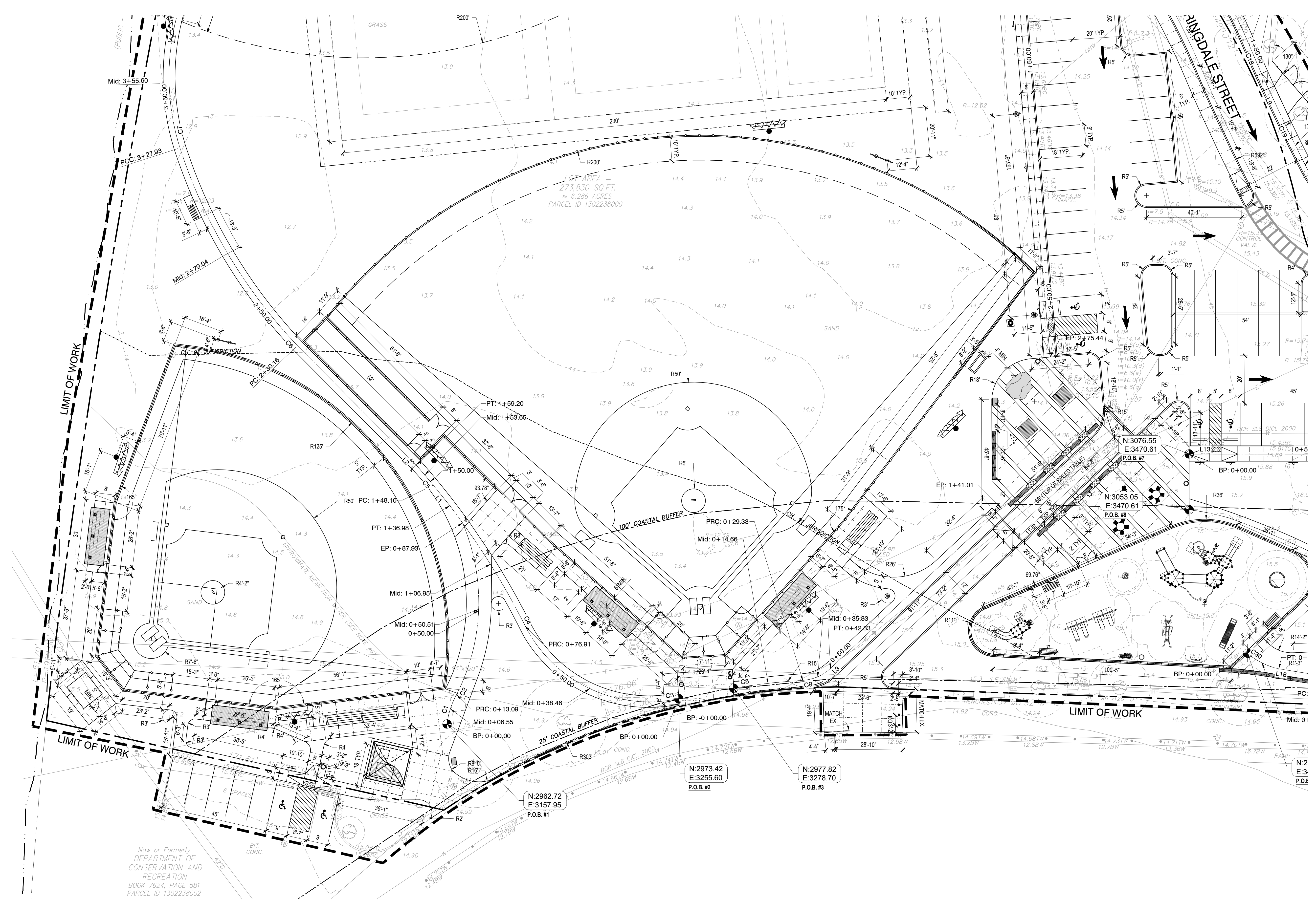

LEGEND

- LIMIT OF WORK
- PROPERTY LINE
- LAND SUBJECT TO COASTAL STORM FLOWAGE - ZONE AE
- 100' COASTAL BUFFER
- 25' COASTAL BUFFER
- ENLARGEMENT PLAN
- CENTER LINE
- 1"=3' TYP. DIMENSION
- TYP. ARC DIMENSION
- TYP. ANGLE DIMENSION

LAYOUT NOTES

REFER TO SHEET L4.00 FOR LAYOUT NOTES.

P.O.B. #1 CURVE TABLE				
CURVE #	RADIUS	LENGTH	BEGIN	END
C1	33.5	13.1	N: 2975.1046 E: 3161.9451	N: 2962.7210 E: 3157.9513
C2	85.5	74.8	N: 2975.1046 E: 3161.9451	N: 3047.5264 E: 3164.4946

P.O.B. #2 CURVE TABLE				
CURVE #	RADIUS	LENGTH	BEGIN	END
C3	58.5	76.9	N: 3003.9308 E: 3190.9462	N: 2973.4211 E: 3255.5998
C4	317.5	60.1	N: 3003.9308 E: 3190.9462	N: 3054.7639 E: 3159.1063
C5	317.5	11.1	N: 3063.4499 E: 3152.1656	N: 3071.8892 E: 3144.9610
C6	219.5	97.8	N: 3205.5795 E: 3045.4152	N: 3122.1983 E: 3094.9213
C7	100.0	55.3	N: 3260.1928 E: 3043.8833	N: 3205.5795 E: 3045.4152

P.O.B. #2 Line Table		
Line #	Length	Direction
L1	11.118	S38° 37' 39.45"E
L2	70.958	S44° 50' 46.28"E

P.O.B. #3 CURVE TABLE				
CURVE #	RADIUS	LENGTH	BEGIN	END
C8	275.0	29.3	N: 2981.1359 E: 3307.8197	N: 2977.8233 E: 3278.6961
C9	19.0	13.0	N: 2981.1359 E: 3307.8197	N: 2986.1760 E: 3319.5229

P.O.B. #3 Line Table		
Line #	Length	Direction
L3	98.684	N46° 50' 10.17"E

1 ATHLETIC FIELDS AND PLAZA ENLARGEMENT PLAN
SCALE: 1" = 20'-0"

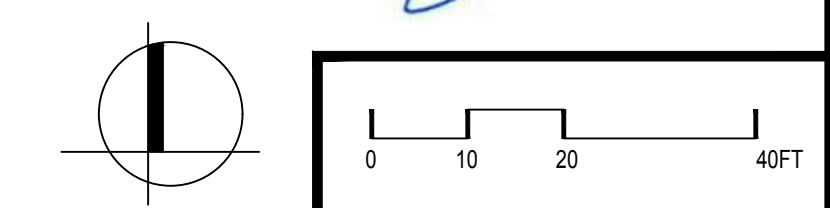

	Prepared By:		No.	Date	Revision	IMPROVEMENTS TO McCONNELL PARK	BWS SUBMISSION Date: FEBRUARY 2021 Scale: 1" = 20'-0" Drawn: ENB, LSR Checked: CFR	SHEET NAME: LAYOUT ENLARGEMENT PLAN	SHEET: L4.01
			Approved By:						

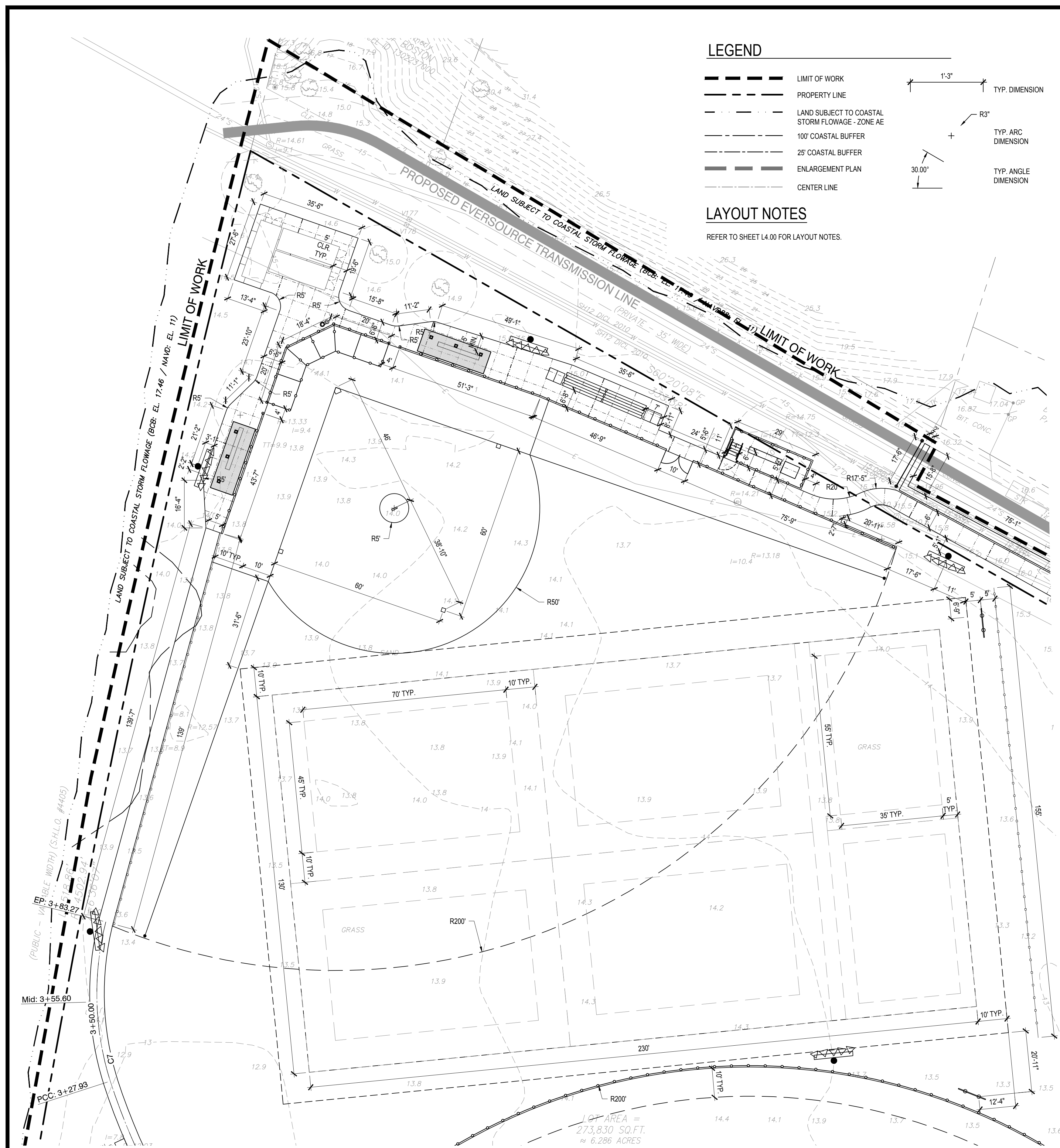

LEGEND

- LIMIT OF WORK
- PROPERTY LINE
- LAND SUBJECT TO COASTAL STORM FLOWAGE - ZONE AE
- 100' COASTAL BUFFER
- 25' COASTAL BUFFER
- ENLARGEMENT PLAN
- CENTER LINE

1" = 3" TYP. DIMENSION

R3" TYP. ARC DIMENSION

30.00' TYP. ANGLE DIMENSION

LAYOUT NOTES
REFER TO SHEET L4.00 FOR LAYOUT NOTES.

1 MULTI-USE FIELD ENLARGEMENT PLAN
SCALE: 1" = 20'-0"

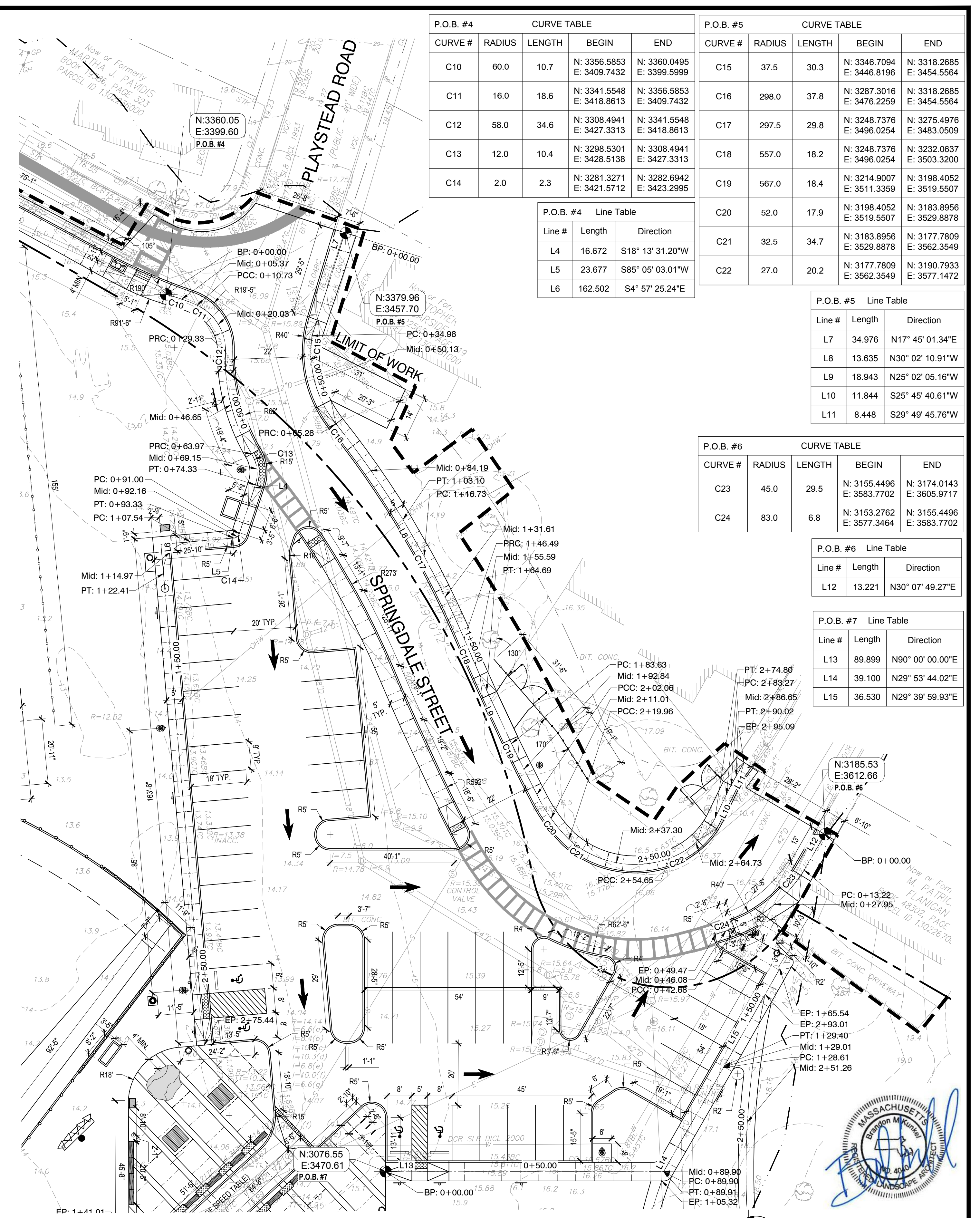

P.O.B. #4 CURVE TABLE

CURVE #	RADIUS	LENGTH	BEGIN	END
C10	60.0	10.7	N: 3356.5853 E: 3409.7432	N: 3360.0495 E: 3399.5999
C11	16.0	18.6	N: 3341.5548 E: 3418.8613	N: 3356.5853 E: 3409.7432
C12	58.0	34.6	N: 3308.4941 E: 3427.3313	N: 3341.5548 E: 3418.8613
C13	12.0	10.4	N: 3298.5301 E: 3428.5138	N: 3308.4941 E: 3427.3313
C14	2.0	2.3	N: 3281.3271 E: 3421.5712	N: 3282.6942 E: 3423.2995

P.O.B. #5 CURVE TABLE

CURVE #	RADIUS	LENGTH	BEGIN	END
C15	37.5	30.3	N: 3346.7094 E: 3446.8196	N: 3318.2685 E: 3454.5564
C16	298.0	37.8	N: 3287.3016 E: 3476.2259	N: 3318.2685 E: 3454.5564
C17	297.5	29.8	N: 3248.7376 E: 3496.0254	N: 3275.4976 E: 3483.0509
C18	557.0	18.2	N: 3248.7376 E: 3496.0254	N: 3232.0637 E: 3503.3200
C19	567.0	18.4	N: 3214.9007 E: 3511.3359	N: 3198.4052 E: 3519.5507
C20	52.0	17.9	N: 3196.4052 E: 3519.5507	N: 3183.8956 E: 3529.8878
C21	32.5	34.7	N: 3183.8956 E: 3529.8878	N: 3177.7809 E: 3562.3549
C22	27.0	20.2	N: 3177.7809 E: 3562.3549	N: 3190.7933 E: 3577.1472

P.O.B. #4 Line Table

Line #	Length	Direction
L4	16.672	S18° 13' 31.20"W
L5	23.677	S85° 05' 03.01"W
L6	162.502	S4° 57' 25.24"E

P.O.B. #5 Line Table

Line #	Length	Direction
L7	34.976	N17° 45' 01.34"E
L8	13.635	N30° 02' 10.91"W
L9	18.943	N25° 02' 05.16"W
L10	11.844	S25° 45' 40.61"W
L11	8.448	S29° 49' 45.76"W

P.O.B. #6 CURVE TABLE

CURVE #	RADIUS	LENGTH	BEGIN	END
C23	45.0	29.5	N: 3155.4496 E: 3583.7702	N: 3174.0143 E: 3605.9717
C24	83.0	6.8	N: 3153.2762 E: 3577.3464	N: 3155.4496 E: 3583.7702

P.O.B. #6 Line Table

Line #	Length	Direction
L12	13.221	N30° 07' 49.27"E

P.O.B. #7 Line Table

Line #	Length	Direction
L13	89.899	N90° 00' 00.00"E
L14	39.100	N29° 53' 44.02"E
L15	36.530	N29° 39' 59.93"E

2 EMERGENCY DRIVE ENLARGEMENT PLAN
SCALE: 1" = 20'-0"



Prepared By:
Weston & Sampson

Consultant Project No.: 2160850

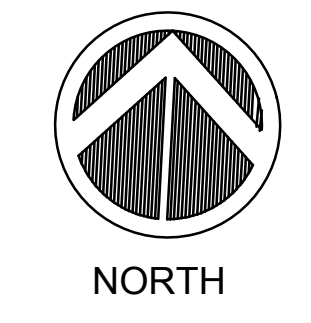

No.	Date	Revision

Approved By: _____ Date: _____

Project Name: **IMPROVEMENTS TO MCCONNELL PARK**

BWSC SUBMISSION

Date: FEBRUARY 2021

Scale: 1" = 20'-0"

Drawn: ENB, LSR

Checked: CFR

Sheet Name: **LAYOUT ENLARGEMENT PLAN**

SHEET: **L4.02**

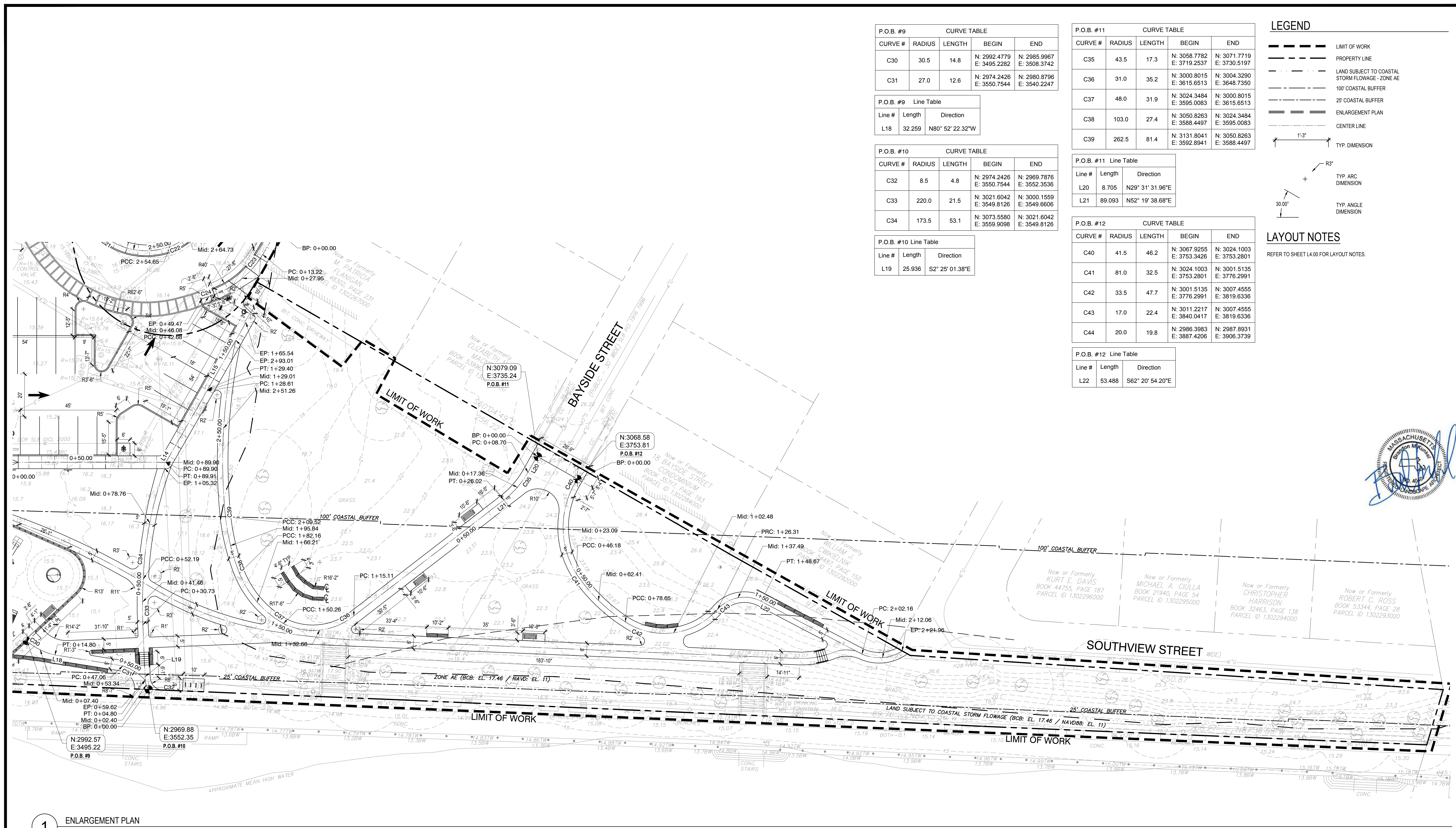

P.O.B. #9 CURVE TABLE				
CURVE #	RADIUS	LENGTH	BEGIN	END
C30	30.5	14.8	N: 2992.4779 E: 3495.2282	N: 2985.9967 E: 3508.3742
C31	27.0	12.6	N: 2974.2426 E: 3550.7544	N: 2980.8796 E: 3540.2247

P.O.B. #9 Line Table		
Line #	Length	Direction
L18	32.259	N80° 52' 22.32"W

P.O.B. #10 CURVE TABLE				
CURVE #	RADIUS	LENGTH	BEGIN	END
C32	8.5	4.8	N: 2974.2426 E: 3550.7544	N: 2969.7876 E: 3552.3536
C33	220.0	21.5	N: 3021.6042 E: 3549.8126	N: 3000.1559 E: 3549.6606
C34	173.5	53.1	N: 3073.5580 E: 3559.9098	N: 3021.6042 E: 3549.8126

P.O.B. #10 Line Table		
Line #	Length	Direction
L19	25.936	S2° 25' 01.38"E

P.O.B. #11 CURVE TABLE				
CURVE #	RADIUS	LENGTH	BEGIN	END
C35	43.5	17.3	N: 3058.7782 E: 3719.2537	N: 3071.7719 E: 3730.5197
C36	31.0	35.2	N: 3000.8015 E: 3615.6513	N: 3004.3290 E: 3648.7350
C37	48.0	31.9	N: 3024.3484 E: 3595.0083	N: 3000.8015 E: 3615.6513
C38	103.0	27.4	N: 3050.8263 E: 3588.4497	N: 3024.3484 E: 3595.0083
C39	262.5	81.4	N: 3131.8041 E: 3592.8941	N: 3050.8263 E: 3588.4497

P.O.B. #11 Line Table		
Line #	Length	Direction
L20	8.705	N29° 31' 31.96"E
L21	89.093	N52° 19' 38.68"E

P.O.B. #12 CURVE TABLE				
CURVE #	RADIUS	LENGTH	BEGIN	END
C40	41.5	46.2	N: 3067.9255 E: 3753.3426	N: 3024.1003 E: 3753.2801
C41	81.0	32.5	N: 3024.1003 E: 3753.2801	N: 3001.5135 E: 3776.2991
C42	33.5	47.7	N: 3001.5135 E: 3776.2991	N: 3007.4555 E: 3819.6336
C43	17.0	22.4	N: 3011.2217 E: 3840.0417	N: 3007.4555 E: 3819.6336
C44	20.0	19.8	N: 2986.3983 E: 3887.4206	N: 2987.8931 E: 3906.3739

P.O.B. #12 Line Table		
Line #	Length	Direction
L22	53.488	S62° 20' 54.20"E

LEGEND

- LIMIT OF WORK
- PROPERTY LINE
- LAND SUBJECT TO COASTAL STORM FLOWAGE - ZONE AE
- 100' COASTAL BUFFER
- 25' COASTAL BUFFER
- ENLARGEMENT PLAN
- CENTER LINE
- 1'-3" TYP. DIMENSION
- R3' TYP. ARC DIMENSION
- 30.00° TYP. ANGLE DIMENSION

LAYOUT NOTES

REFER TO SHEET L4.00 FOR LAYOUT NOTES.



1 ENLARGEMENT PLAN
SCALE: 1" = 10'-0"

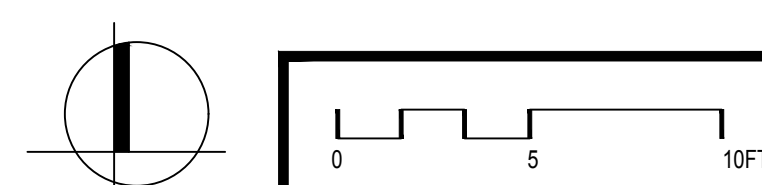

	Prepared By:		No.	Date	Revision	IMPROVEMENTS TO McCONNELL PARK	Project Name.:	BWS SUBMISSION Date: FEBRUARY 2021 Scale: 1" = 10'-0" Drawn: ENB, LSR Checked: CFR	Sheet Name.: LAYOUT ENLARGEMENT PLAN	SHEET: L4.03
			Approved By:							

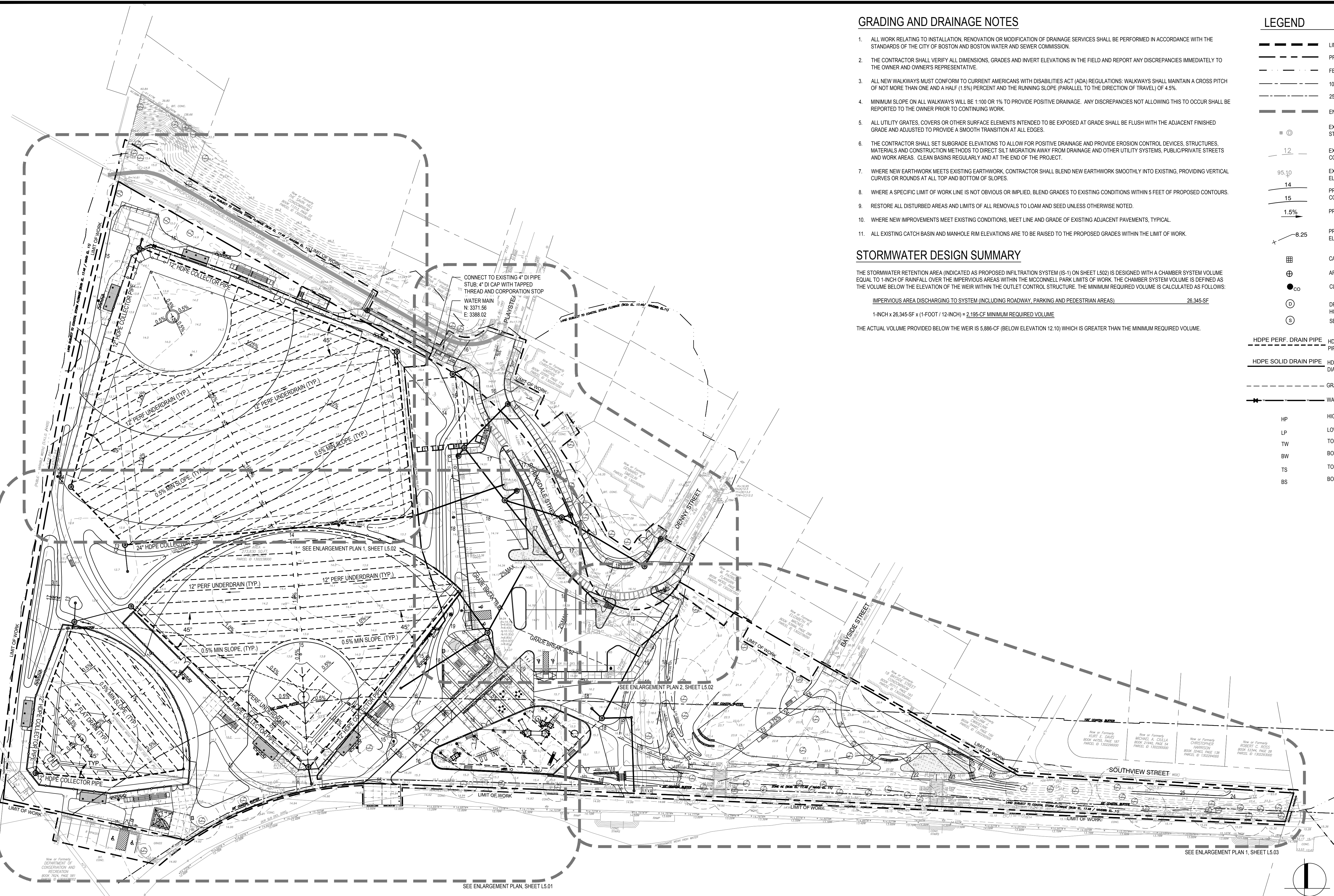

GRADING AND DRAINAGE NOTES

1. ALL WORK RELATING TO INSTALLATION, RENOVATION OR MODIFICATION OF DRAINAGE SERVICES SHALL BE PERFORMED IN ACCORDANCE WITH THE STANDARDS OF THE CITY OF BOSTON AND BOSTON WATER AND SEWER COMMISSION.
2. THE CONTRACTOR SHALL VERIFY ALL DIMENSIONS, GRADES AND INVERT ELEVATIONS IN THE FIELD AND REPORT ANY DISCREPANCIES IMMEDIATELY TO THE OWNER AND OWNER'S REPRESENTATIVE.
3. ALL NEW WALKWAYS MUST CONFORM TO CURRENT AMERICANS WITH DISABILITIES ACT (ADA) REGULATIONS: WALKWAYS SHALL MAINTAIN A CROSS PITCH OF NOT MORE THAN ONE AND A HALF (1.5%) PERCENT AND THE RUNNING SLOPE (PARALLEL TO THE DIRECTION OF TRAVEL) OF 4.5%.
4. MINIMUM SLOPE ON ALL WALKWAYS WILL BE 1:100 OR 1% TO PROVIDE POSITIVE DRAINAGE. ANY DISCREPANCIES NOT ALLOWING THIS TO OCCUR SHALL BE REPORTED TO THE OWNER PRIOR TO CONTINUING WORK.
5. ALL UTILITY GRATES, COVERS OR OTHER SURFACE ELEMENTS INTENDED TO BE EXPOSED AT GRADE SHALL BE FLUSH WITH THE ADJACENT FINISHED GRADE AND ADJUSTED TO PROVIDE A SMOOTH TRANSITION AT ALL EDGES.
6. THE CONTRACTOR SHALL SET SUBGRADE ELEVATIONS TO ALLOW FOR POSITIVE DRAINAGE AND PROVIDE EROSION CONTROL DEVICES, STRUCTURES, MATERIALS AND CONSTRUCTION METHODS TO DIRECT SILT MIGRATION AWAY FROM DRAINAGE AND OTHER UTILITY SYSTEMS, PUBLIC/Private STREETS AND WORK AREAS. CLEAN BASINS REGULARLY AND AT THE END OF THE PROJECT.
7. WHERE NEW EARTHWORK MEETS EXISTING EARTHWORK, CONTRACTOR SHALL BLEND NEW EARTHWORK SMOOTHLY INTO EXISTING, PROVIDING VERTICAL CURVES OR ROUNDS AT ALL TOP AND BOTTOM OF SLOPES.
8. WHERE A SPECIFIC LIMIT OF WORK LINE IS NOT OBVIOUS OR IMPLIED, BLEND GRADES TO EXISTING CONDITIONS WITHIN 5 FEET OF PROPOSED CONTOURS.
9. RESTORE ALL DISTURBED AREAS AND LIMITS OF ALL REMOVALS TO LOAM AND SEED UNLESS OTHERWISE NOTED.
10. WHERE NEW IMPROVEMENTS MEET EXISTING CONDITIONS, MEET LINE AND GRADE OF EXISTING ADJACENT PAVEMENTS, TYPICAL.
11. ALL EXISTING CATCH BASIN AND MANHOLE RIM ELEVATIONS ARE TO BE RAISED TO THE PROPOSED GRADES WITHIN THE LIMIT OF WORK.

STORMWATER DESIGN SUMMARY

THE STORMWATER RETENTION AREA (INDICATED AS PROPOSED INFILTRATION SYSTEM (IS-1) ON SHEET L5.02) IS DESIGNED WITH A CHAMBER SYSTEM VOLUME EQUAL TO 1-INCH OF RAINFALL OVER THE IMPERVIOUS AREAS WITHIN THE MCCONNELL PARK LIMITS OF WORK. THE CHAMBER SYSTEM VOLUME IS DEFINED AS THE VOLUME BELOW THE ELEVATION OF THE WEIR WITHIN THE OUTLET CONTROL STRUCTURE. THE MINIMUM REQUIRED VOLUME IS CALCULATED AS FOLLOWS:

IMPERVIOUS AREA DISCHARGING TO SYSTEM (INCLUDING ROADWAY, PARKING AND PEDESTRIAN AREAS) 26,345-SF

1-INCH x 26,345-SF x (1-FOOT / 12-INCH) = 2,195-CF MINIMUM REQUIRED VOLUME

THE ACTUAL VOLUME PROVIDED BELOW THE WEIR IS 5,886-CF (BELOW ELEVATION 12.10) WHICH IS GREATER THAN THE MINIMUM REQUIRED VOLUME.

LEGEND

- LIMIT OF WORK
- PROPERTY LINE
- - - FEMA Q3 FLOOD LINE
- - - 100' COASTAL BUFFER
- - - 25' COASTAL BUFFER
- ENLARGEMENT PLAN
- ⊕ EXISTING DRAINAGE STRUCTURE
- 12 EXISTING CONTOURS
- 95.10 EXISTING SPOT ELEVATION
- 14 EXISTING CONTOURS
- 15 PROPOSED CONTOURS
- 1.5% PROPOSED SLOPE
- 8.25 PROPOSED SPOT ELEVATION
- ⊕ CATCH BASIN
- ⊕ AREA DRAIN
- ⊙ CLEAN OUT
- ⊕ DRAINAGE MAN HOLE
- ⊙ SEWER MAN HOLE
- HDPE PERF. DRAIN PIPE HDPE PERFORATED DRAIN PIPE, DIAMETER VARIES
- HDPE SOLID DRAIN PIPE HDPE SOLID DRAIN PIPE, DIAMETER VARIES
- GRADE BREAK
- WATER LINE
- HP HIGH POINT
- LP LOW POINT
- TW TOP OF WALL
- BW BOTTOM OF WALL
- TS TOP OF STEP
- BS BOTTOM OF STEP

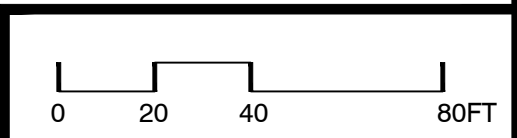

Prepared By:
Weston & Sampson
 Consultant Project No. 2160850

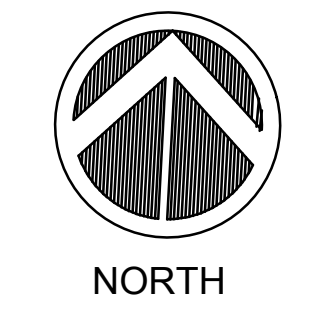

No.	Date	Revision

Approved By: _____ Date: _____

Project Name.:
IMPROVEMENTS TO MCCONNELL PARK

BWSC SUBMISSION
 Date: FEBRUARY 2021
 Scale: 1" = 40'-0"
 Drawn: ENB, LSR
 Checked: CFR

Sheet Name.:
OVERALL GRADING, DRAINAGE, AND UTILITY PLAN

SHEET:
L5.00

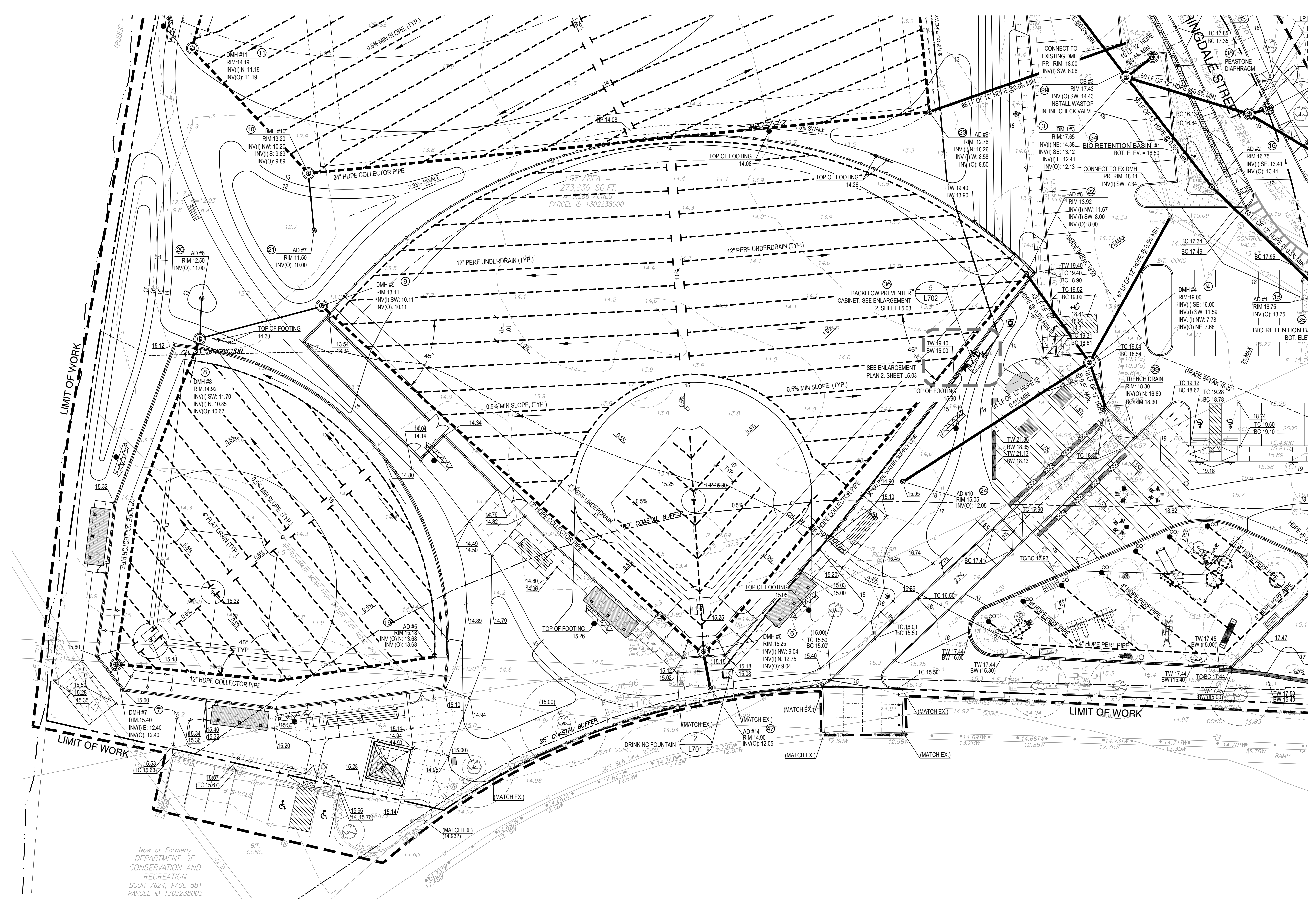

- ### LEGEND
- LIMIT OF WORK
 - - - - - PROPERTY LINE
 - - - - - FEMA Q3 FLOOD LINE
 - - - - - 100' COASTAL BUFFER
 - - - - - 25' COASTAL BUFFER
 - ENLARGEMENT PLAN
 - EXISTING DRAINAGE STRUCTURE
 - 12' EXISTING CONTOURS
 - 95.10 EXISTING SPOT ELEVATION
 - 14' PROPOSED CONTOURS
 - 1.5% PROPOSED SLOPE
 - 8.25' PROPOSED SPOT ELEVATION
 - CATCH BASIN
 - ⊕ AREA DRAIN
 - CLEAN OUT
 - DRAINAGE MAN HOLE
 - SEWER MAN HOLE
 - HDPE PERF. DRAIN PIPE
 - HDPE SOLID DRAIN PIPE
 - GRADE BREAK
 - WATER LINE
 - HP HIGH POINT
 - LP LOW POINT
 - TW TOP OF WALL
 - BW BOTTOM OF WALL
 - TS TOP OF STEP
 - BS BOTTOM OF STEP
 - DO NOT DUMP PLAQUE, 4 TOTAL

GRADING, DRAINAGE, AND UTILITY NOTES

REFER TO SHEET L5.00 FOR GRADING, DRAINAGE, AND UTILITY NOTES.

1 ATHLETIC FIELDS AND PLAZA ENLARGEMENT PLAN
SCALE: 1" = 20'-0"

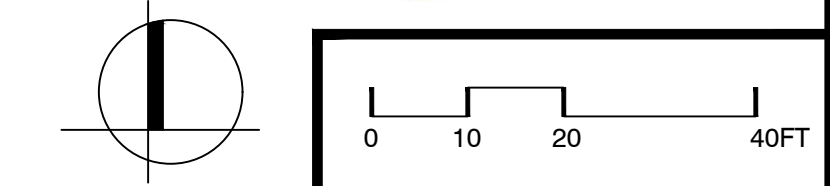

	Prepared By:		No.	Date	Revision	Project Name: IMPROVEMENTS TO McCONNELL PARK	BWSO SUBMISSION Date: FEBRUARY 2021 Scale: 1" = 20'-0" Drawn: ENB, LSR Checked: CFR	Sheet Name.: GRADING, DRAINAGE, AND UTILITY ENLARGEMENT PLAN	L5.01
			Approved By: _____ Date: _____						

STORMWATER DESIGN SUMMARY

THE STORMWATER INFILTRATION SYSTEM (IS-1) IS DESIGNED WITH A VOLUME EQUAL TO 1-INCH OF RAINFALL OVER THE TOTAL PROPOSED IMPERVIOUS AREA WITHIN THE LIMIT OF WORK. THE SYSTEM VOLUME IS DEFINED AS THE VOLUME BELOW THE LOWEST OUTLET STRUCTURE RIM ELEVATION. THE MINIMUM REQUIRED VOLUME IS CALCULATED AS FOLLOWS:

TOTAL PROPOSED IMPERVIOUS AREA: 69,383 S.F.

1" x 69,383 S.F. x (1-FOOT/12-INCH) = 5781 C.F. MINIMUM REQUIRED VOLUME

THE ACTUAL VOLUME PROVIDED IN THE SYSTEM IS 6361 C.F. WHICH IS GREATER THAN THE MINIMUM REQUIRED VOLUME.

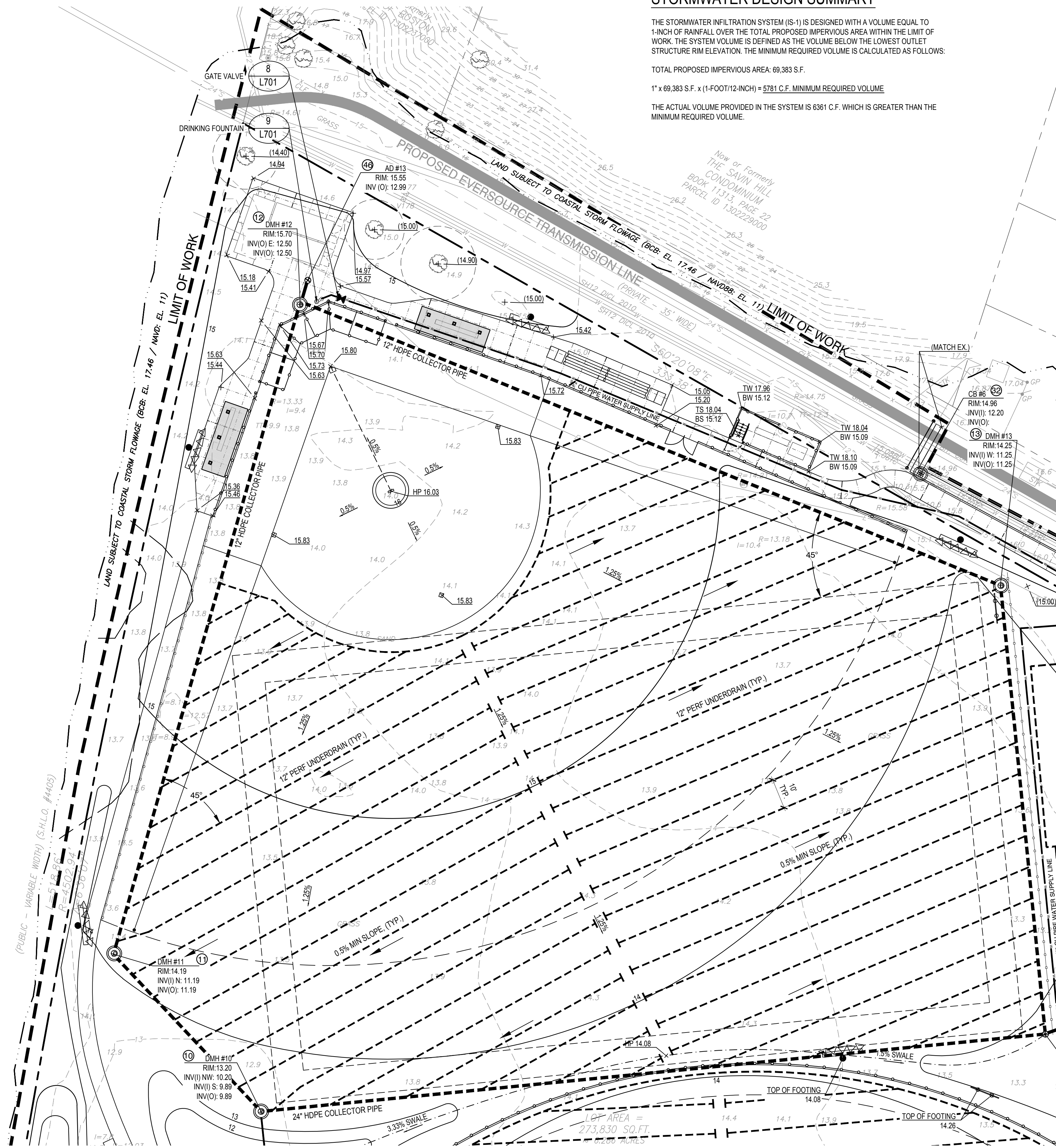

1 MULTI-USE FIELD ENLARGEMENT PLAN
SCALE: 1" = 20'-0"

GRADING, DRAINAGE, AND UTILITY NOTES

REFER TO SHEET L5.00 FOR GRADING, DRAINAGE, AND UTILITY NOTES.

LEGEND

- LIMIT OF WORK
- PROPERTY LINE
- FEMA Q3 FLOOD LINE
- 100' COASTAL BUFFER
- 25' COASTAL BUFFER
- ENLARGEMENT PLAN
- EXISTING DRAINAGE STRUCTURE
- EXISTING CONTOURS
- EXISTING SPOT ELEVATION
- PROPOSED CONTOURS
- PROPOSED SLOPE
- PROPOSED SPOT ELEVATION
- CATCH BASIN
- AREA DRAIN
- CLEAN OUT
- DRAINAGE MAN HOLE
- SEWER MAN HOLE
- HDPE PERF. DRAIN PIPE: HDPE PERFORATED DRAIN PIPE, DIAMETER VARIES
- HDPE SOLID DRAIN PIPE: HDPE SOLID DRAIN PIPE, DIAMETER VARIES
- GRADE BREAK
- WATER LINE
- HP: HIGH POINT
- LP: LOW POINT
- TW: TOP OF WALL
- BW: BOTTOM OF WALL
- TS: TOP OF STEP
- BS: BOTTOM OF STEP
- DO NOT DUMP PLAQUE, 4 TOTAL

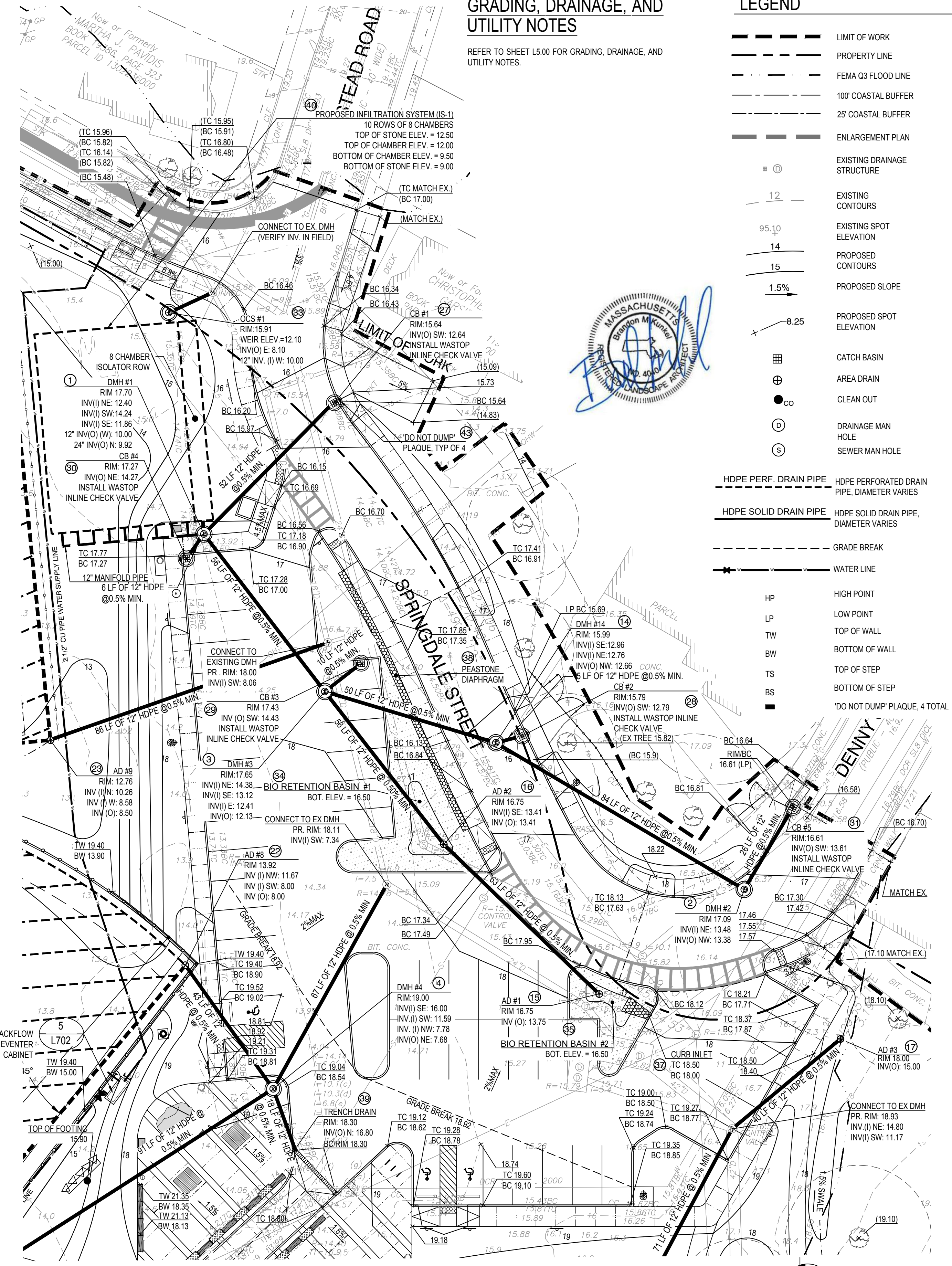

2 RIGHT-OF-WAY ENLARGEMENT PLAN
SCALE: 1" = 20'-0"



Prepared By:

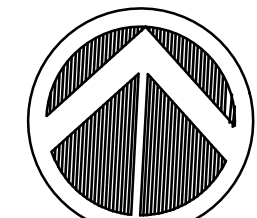

Consultant Project No. 2160850

No.	Date	Revision

Approved By: _____ Date: _____

Project Name: _____

IMPROVEMENTS TO MCCONNELL PARK

BWSC SUBMISSION

Date: FEBRUARY 2021
Scale: 1" = 20'-0"
Drawn: ENB, LSR
Checked: CFR

Sheet Name: _____

GRADING, DRAINAGE, AND UTILITY ENLARGEMENT PLAN

SHEET: _____

L5.02

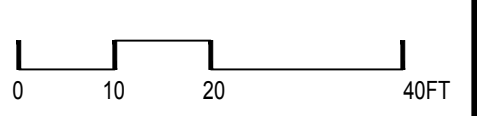

GRADING, DRAINAGE, AND UTILITY NOTES

REFER TO SHEET L5.00 FOR GRADING, DRAINAGE, AND UTILITY NOTES.

LEGEND

- LIMIT OF WORK
- PROPERTY LINE
- - - FEMA Q3 FLOOD LINE
- - - 100' COASTAL BUFFER
- - - 25' COASTAL BUFFER
- ENLARGEMENT PLAN
- ⊕ EXISTING DRAINAGE STRUCTURE
- 12 EXISTING CONTOURS
- 95.10 EXISTING SPOT ELEVATION
- 14 EXISTING SPOT ELEVATION
- 15 PROPOSED CONTOURS
- 1.5% PROPOSED SLOPE
- 8.25 PROPOSED SPOT ELEVATION
- ⊕ CATCH BASIN
- ⊕ AREA DRAIN
- ⊕ CLEAN OUT
- ⊕ DRAINAGE MAN HOLE
- ⊕ SEWER MAN HOLE
- HDPE PERF. DRAIN PIPE HDPE PERFORATED DRAIN PIPE, DIAMETER VARIES
- HDPE SOLID DRAIN PIPE HDPE SOLID DRAIN PIPE, DIAMETER VARIES
- GRADE BREAK
- WATER LINE
- HP HIGH POINT
- LP LOW POINT
- TW TOP OF WALL
- BW BOTTOM OF WALL
- TS TOP OF STEP
- BS BOTTOM OF STEP

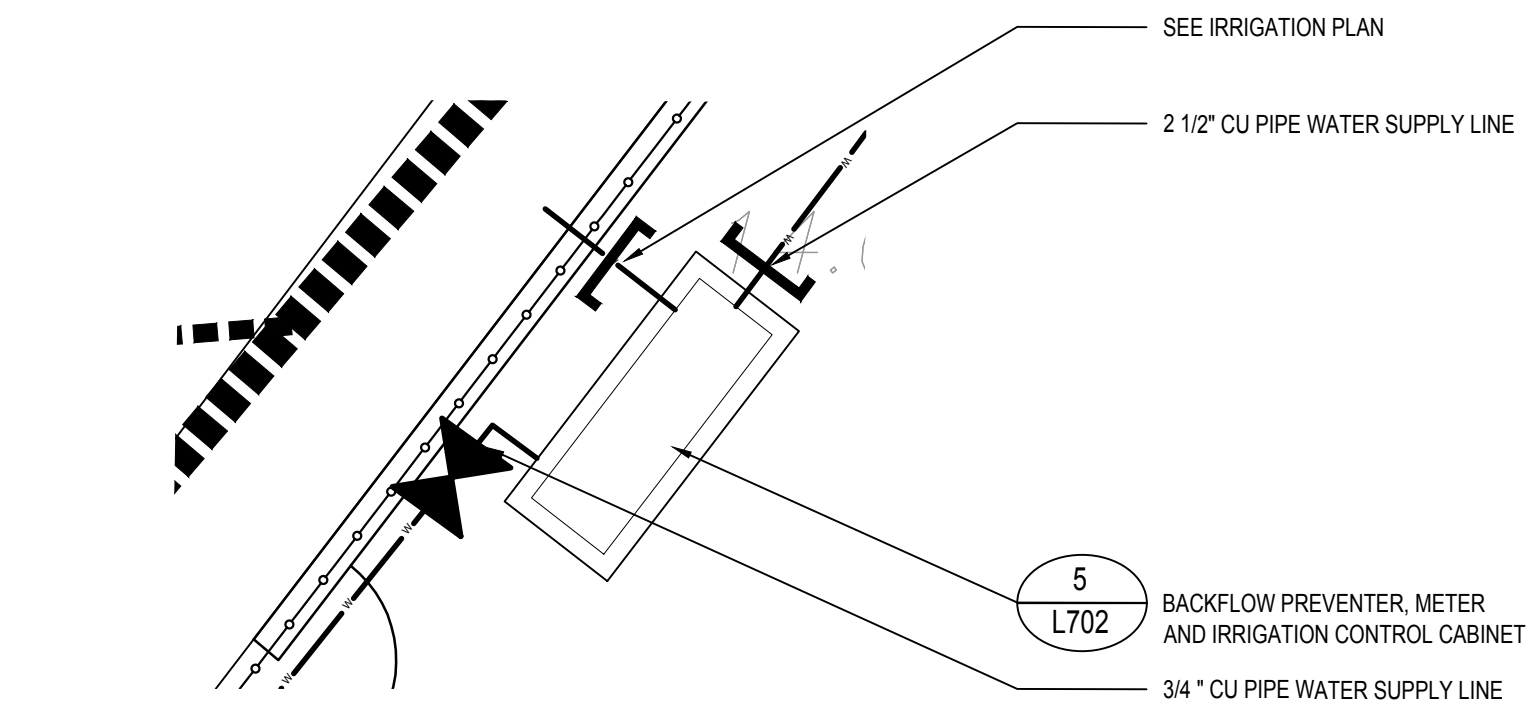

2 ENLARGEMENT - BACKFLOW PREVENTER
SCALE: NTS

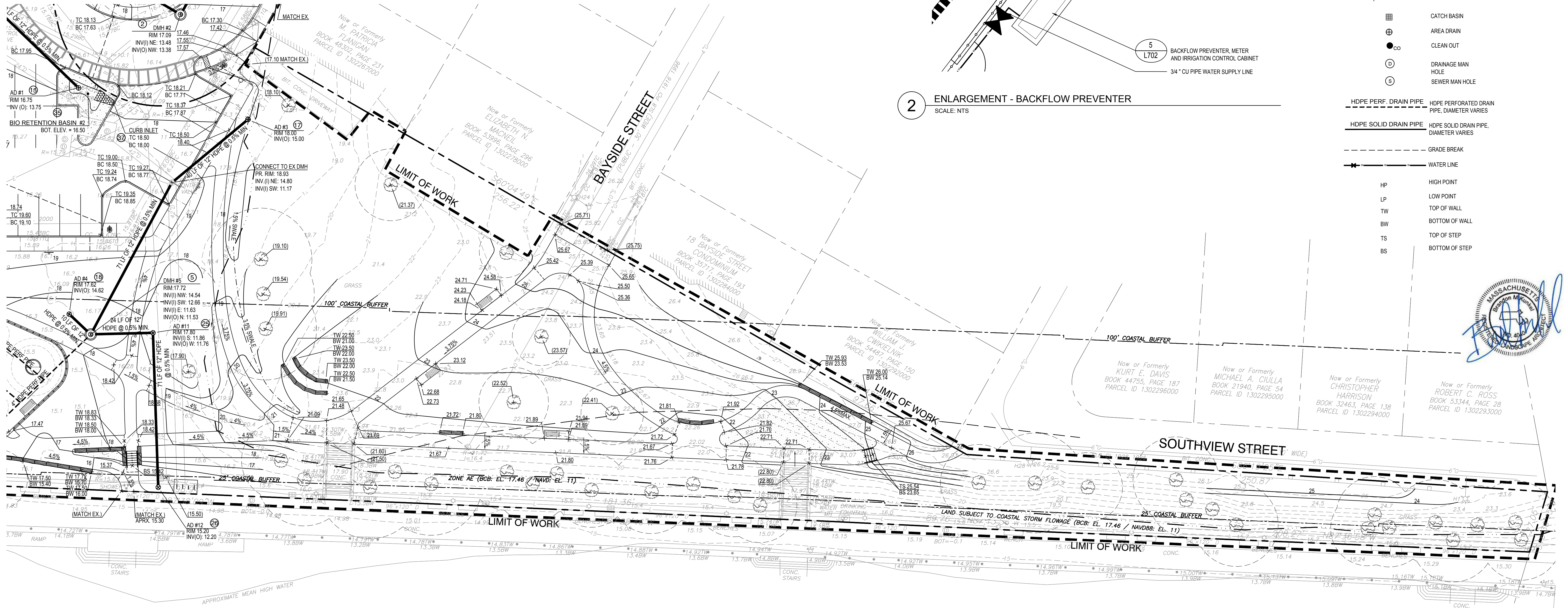

1 ENLARGEMENT PLAN
SCALE: 1" = 10'-0"



Prepared By:
Weston & Sampson
Consultant Project No. 2160850

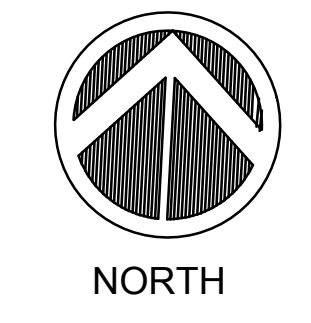

No.	Date	Revision

Approved By: _____ Date: _____

Project Name:
IMPROVEMENTS TO MCCONNELL PARK

BWSC SUBMISSION
Date: FEBRUARY 2021
Scale: 1" = 10'-0"
Drawn: ENB, LSR
Checked: CFR

Sheet Name:
GRADING, DRAINAGE, AND UTILITY ENLARGEMENT PLAN

SHEET:
L5.03

PLANTING SCHEDULE

TREES					
AR	10	RED MAPLE	ACER RUBRUM	3-3.5" CAL. B&B	LIMBED UP 8'
JV	16	EASTERN RED CEDAR	JUNIPERUS VIRGINIANA	3-3.5" CAL. B&B	LIMBED UP 8'
PL	9	PLANE TREE	PLATANUS OCCIDENTALIS	2-2.5" CAL. APRX.	LIMBED UP 8'
PM	8	PIN OAK	QUERCUS PALUSTRIS	2-2.5" CAL. APRX.	LIMBED UP 8'
QA	11	WHITE OAK	QUERCUS ALBA	2-2.5" CAL. APRX.	LIMBED UP 8'
QC	3	SCARLET OAK	QUERCUS COCCINEA	2-2.5" CAL. APRX.	LIMBED UP 8'

LEGEND

- LIMIT OF WORK
- PROPERTY LINE
- LAND SUBJECT TO COASTAL STORM FLOWAGE - ZONE AE
- 100' COASTAL BUFFER
- 25' COASTAL BUFFER
- ENLARGEMENT PLAN
- LOAM & SEED
- FILL AND OVER SEED WITH SLOPE MIX AS NEEDED
- PROPOSED TREES
- PROPOSED SHRUBS
- EXISTING TREES TO REMAIN

PLANTING NOTES

- THE DEPTH OF AMENDED TOPSOIL LOAM FOR ALL PROPOSED LAWN AREAS SHALL BE 6" MINIMUM. ALL DISTURBED AREAS SHALL BE RESTORED WITH LOAM AND SEED UNLESS OTHERWISE NOTED
- ALL REFERENCES TO LOAM AND SEED REFER TO HYDROMULCH SEEDED LAWN.

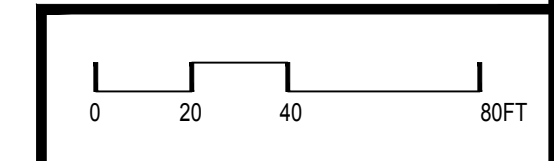
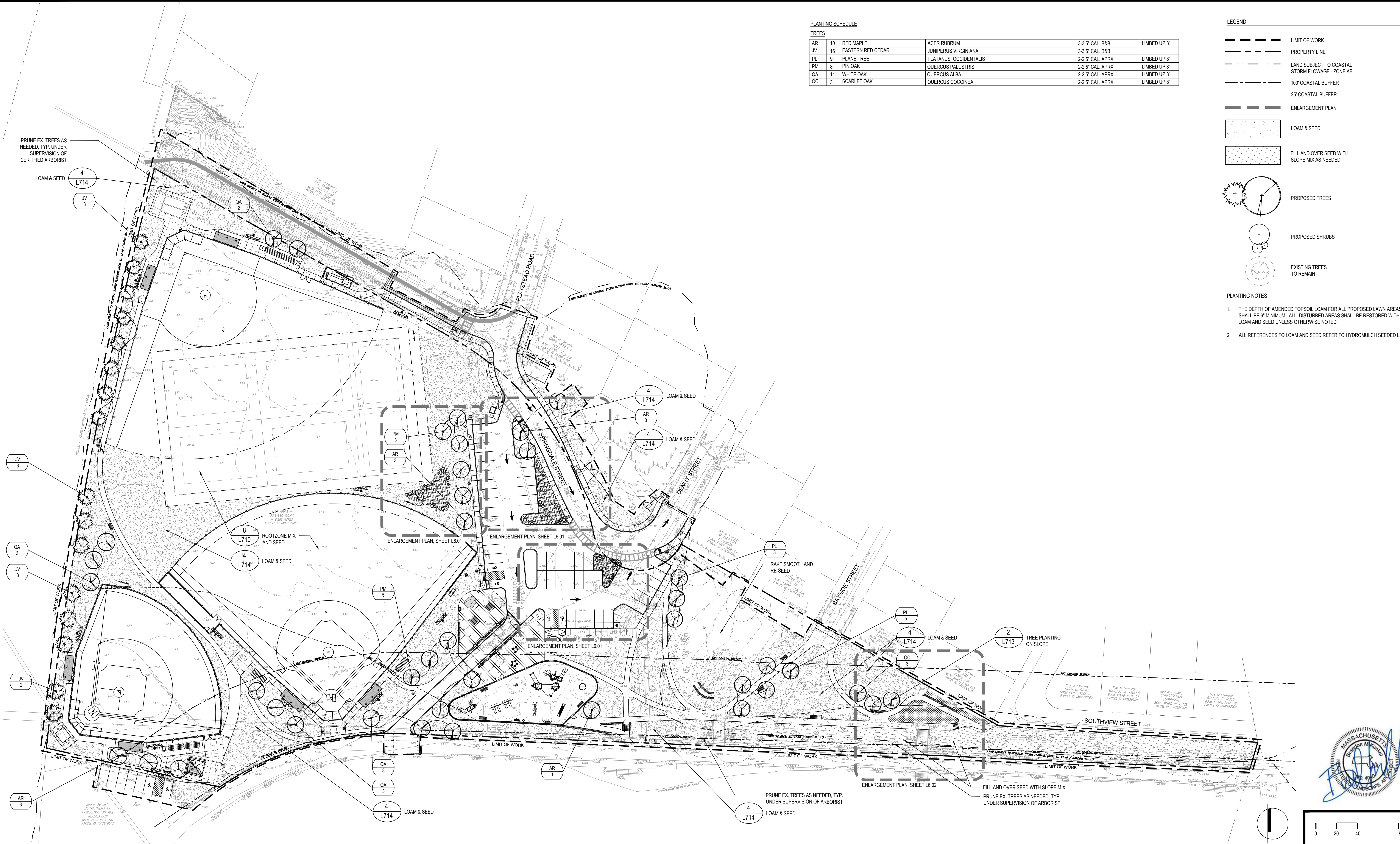

Weston & Sampson

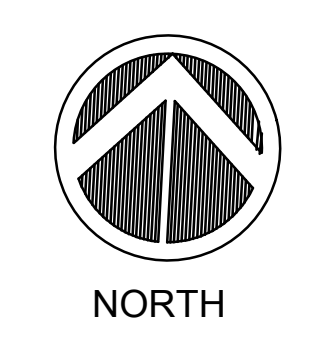

No.	Date	Revision

Approved By: _____ Date: _____

Project Name.: **IMPROVEMENTS TO McCONNELL PARK**

BWSC SUBMISSION
 Date: FEBRUARY 2021
 Scale: 1" = 40'-0"
 Drawn: ENB, LSR
 Checked: CFR

Sheet Name.: **PLANTING PLAN**

SHEET: **L6.00**

Consultant Project No. 2160850

PLANTING NOTES
SEE SHEET L6.00

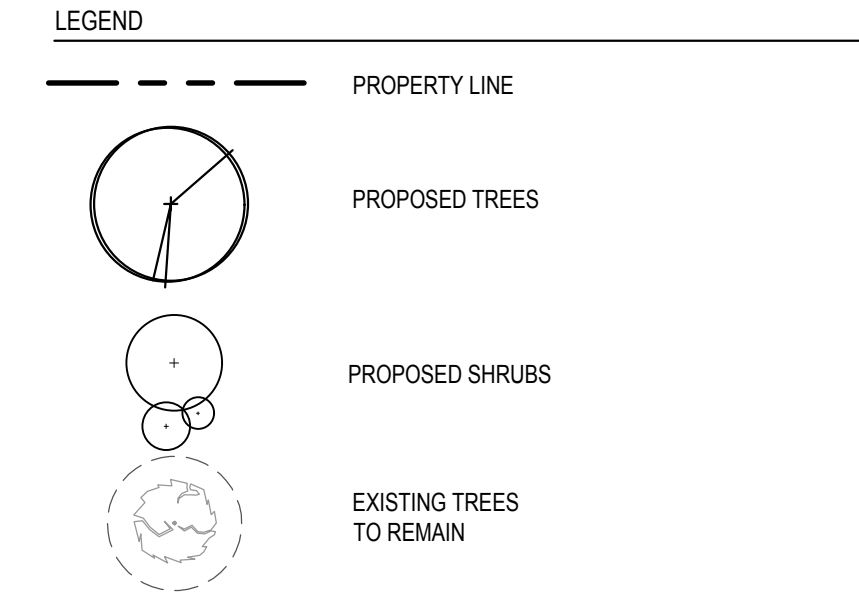

SHRUB PLANTING SCHEDULE

AC	#	ALLEGHANY SERVICEBERRY	AMELANCHIER CANADENSIS	#7 POT	MULTISTEM
CA	8	SUMMERSWEET	CLETHRA ALNIFOLIA	#7 POT	
AM	11	BLACK CHOKEBERRY	ARONIA MELANOCARPA	#3 POT	
CS	42	REDTWIG DOGWOOD	CORNUS SERICEA 'CARDINAL'	#3 POT	
RA	50	GRO LOW SUMAC	RHUS AROMATIC	#2 POT	

STORMWATER PLANTING AREA SEED MIX

MIX RATIO:	INDIAN GRASS	SORGHASTRUM NUTANS
EQUAL	LITTLE BLUESTEM	SCHIZACHYRIUM SCOPARIUM
	FOX SEDGE	CAREX VULPINOIDES
	BLUNT BROOM SEDGE	CAREX SCOPARIA
	NEW ENGLAND ASTER	ASTER NOVAE-ANGLIAE
	HOLLOW STEM JOE PYE WEED	EUPATORIUM FISTULOSUM
	BLUE VERVAIN	VERBENA HASTATA
	BLUE FLAG IRIS	IRIS VERSICOLOR

SHOWY SEED MIX

MIX RATIO:	CANADIAN WILD RYE	ELYMIUS CANADENSIS
EQUAL	LITTLE BLUESTEM	SCHIZACHYRIUM SCOPARIUM
	CANADA LILY	LILIUM CANADENSE
	CUTLEAF CONEFLOWER	RUDBECKIA LACINIATA
	SWEET GOLDENROD	SOLIDAGO ODORA
	HOLLOWSTEM JOE PYE WEED	EUPATORIUM MACULATUM
	WILD INDIGO	BAPTISIA TINCTORIA

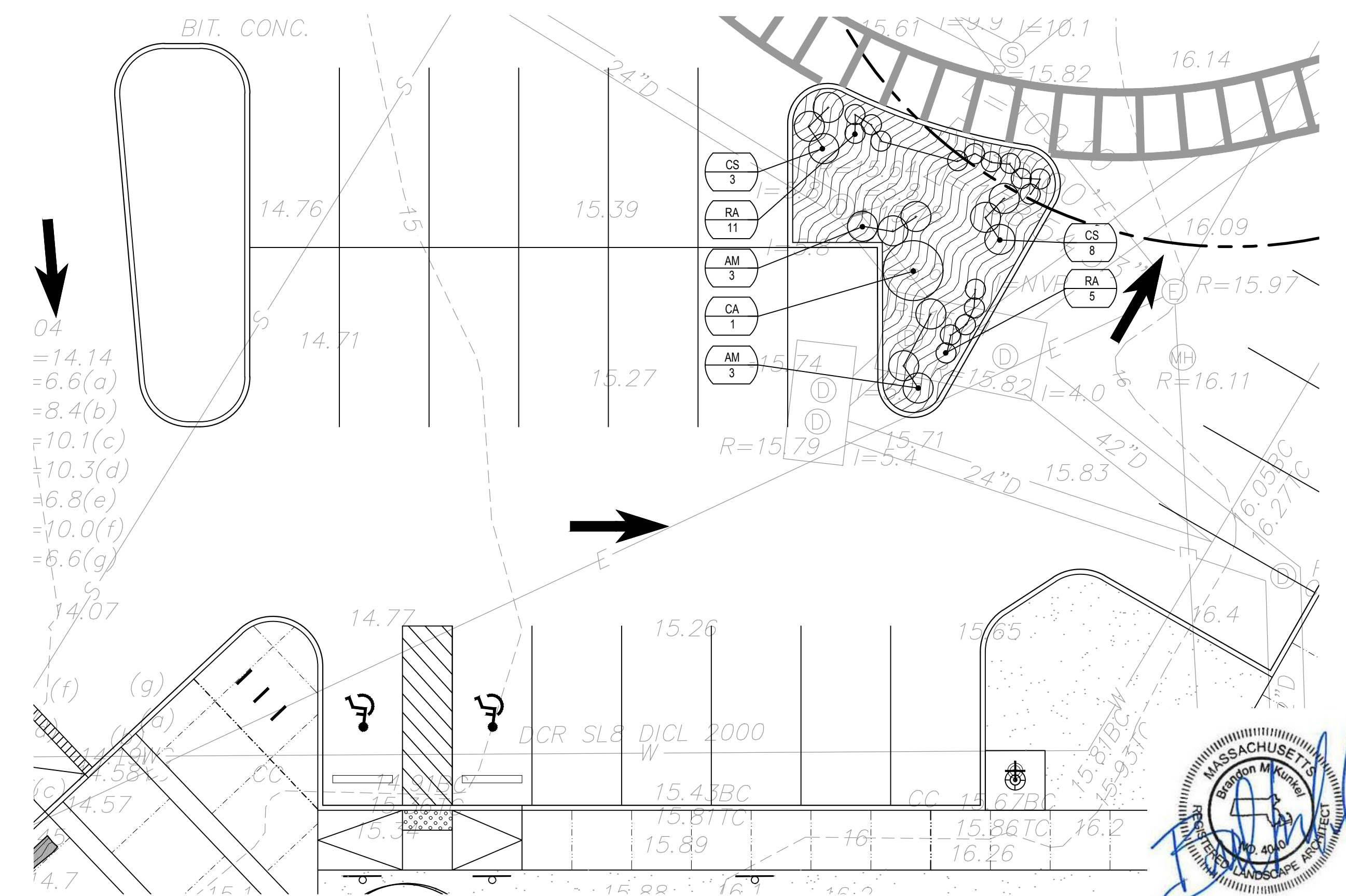
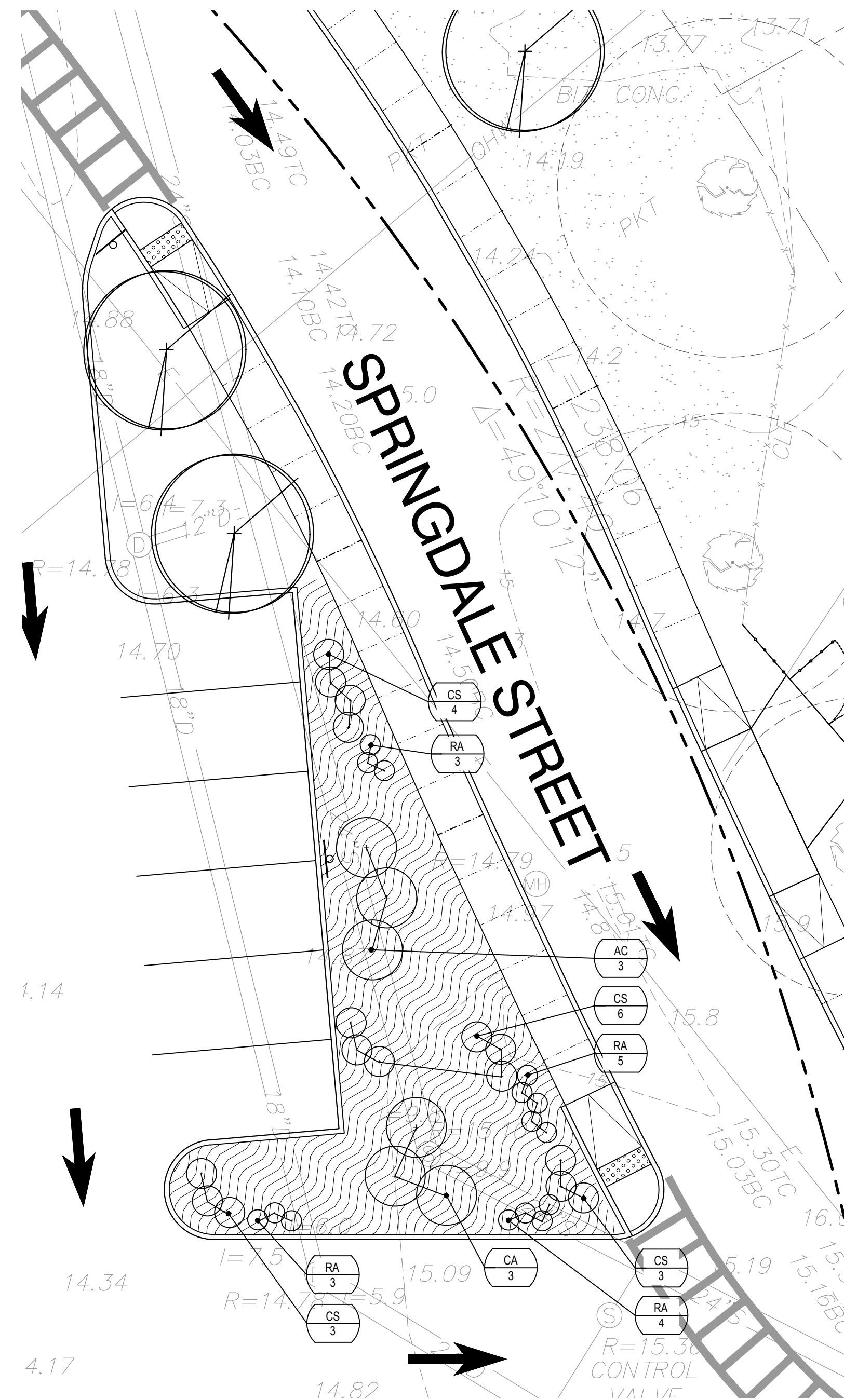
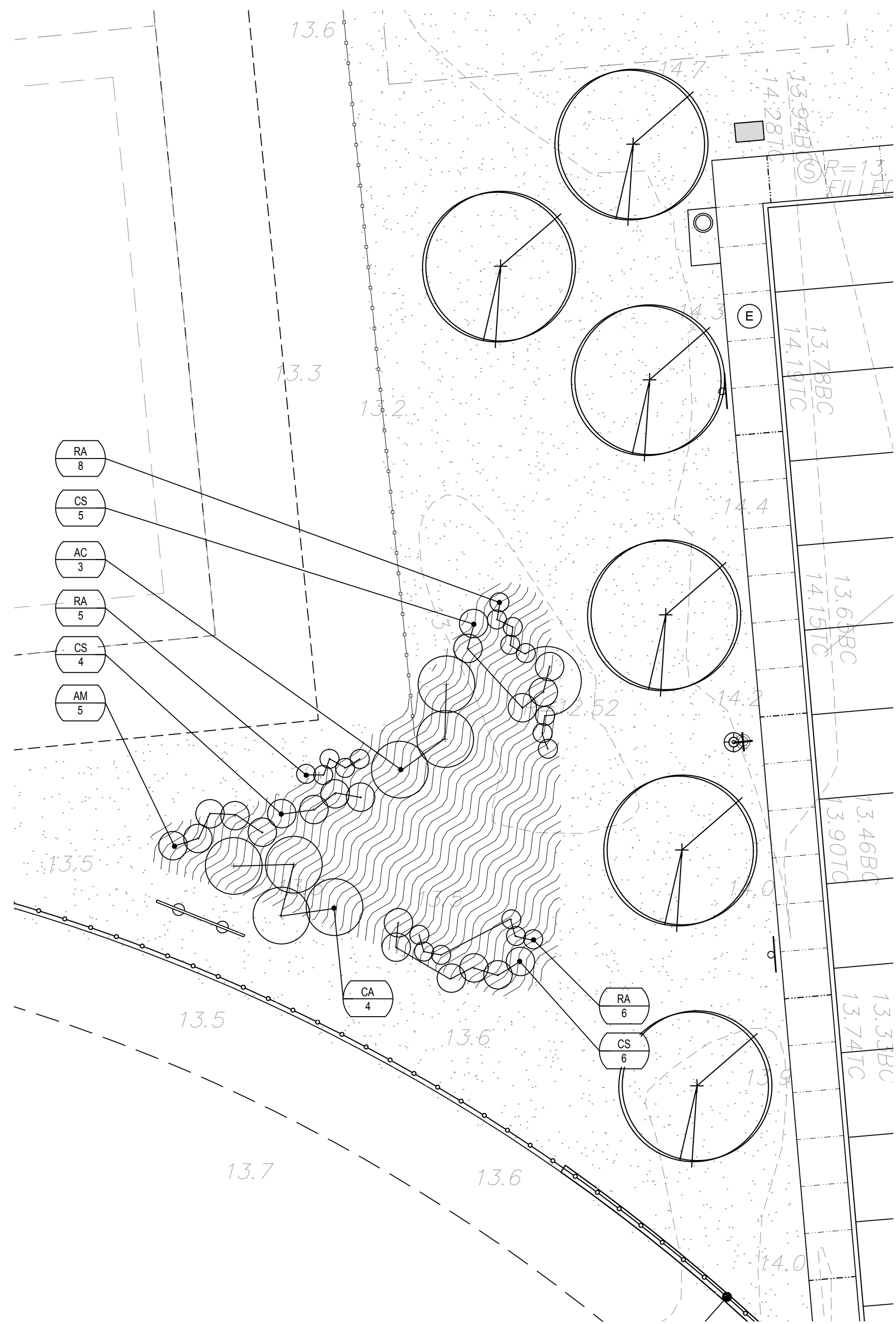

1 STORMWATER COLLECTION AT FIELD - ENLARGEMENT PLAN
SCALE: 1" = 10'-0"

2 STORMWATER COLLECTION IN PARKING LOT - ENLARGEMENT PLAN
SCALE: 1" = 10'-0"

3 STORMWATER COLLECTION IN PARKING LOT - ENLARGEMENT PLAN
SCALE: 1" = 10'-0"

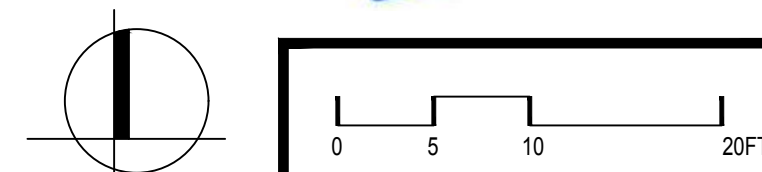

Prepared By:
Weston & Sampson
Consultant Project No. 2160850

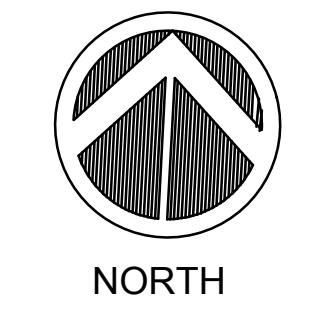

No.	Date	Revision

Approved By: _____ Date: _____

Project Name.:
**IMPROVEMENTS TO
McCONNELL PARK**

BWSC SUBMISSION
Date: FEBRUARY 2021
Scale: 1" = 20'-0"
Drawn: ENB, LSR
Checked: CFR

Sheet Name.:
PLANTING ENLARGEMENT PLAN

SHEET:
L6.01

PLANTING NOTES
SEE SHEET L6.00

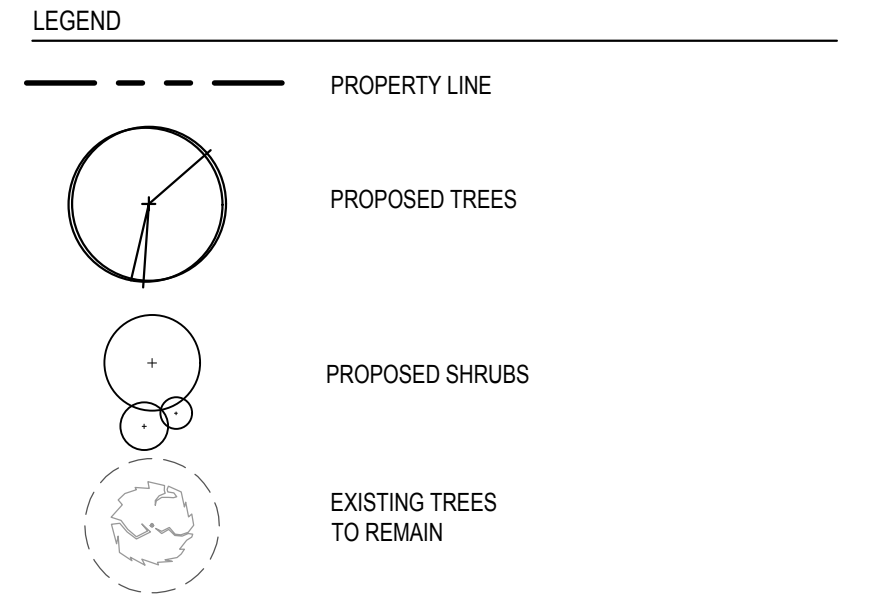

EROSION CONTROL SEED MIX (OR SIMILAR NATIVES)

RED FESCUE (FESTUCA RUBRA), CANADA WILD RYE (ELYMUS CANADENSIS), ANNUAL RYEGRASS (LOLIUM MULTIFLORUM), PERENNIAL RYEGRASS (LOLIUM PERENNE), LITTLE BLUESTEM (SCHIZACHYRIUM SCOPARIUM), INDIAN GRASS (SORGHASTRUM NUTANS), SWITCH GRASS (PANICUM VIRGATUM), UPLAND BENTGRASS (AGROSTIS PERENNANS), VIRGINIA WILD RYE (ELYMUS VIRGINICUS), PARTRIDGE PEA (CHAMAECRISTA FASCICULATA), BUTTERFLY MILKWEED (ASCLEPIAS TUBEROSA), PANICLEDLEAF TICK TREFLOIL (DESMODIUM PANICULATUM), BEARD TONGUE (PENSTEMON DIGITALIS), BLACK EYED SUSAN (RUDBECKIA HIRTA), HOLLOW-STEM JOE PYE WEED (EUPATORIUM FISTULOSUM/EUTROCHIUM FISTULOSUM), BLUE VERVAIN (VERBENA HASTATA)

SHOWY SEED MIX

CANADIAN WILD RYE	ELYMUS CANADENSIS
LITTLE BLUESTEM	SCHIZACHYRIUM SCOPARIUM
CANADA LILY	LILIUM CANADENSE
CUTLEAF CONEFLOWER	RUDBECKIA LACINIATA
SWEET GOLDENROD	SOLIDAGO ODORA
HOLLOWSTEM JOE PYE WEED	EUPATORIUM MACULATUM
WILD INDIGO	BAPTISIA TINCTORIA

MIX RATIO:
EQUAL

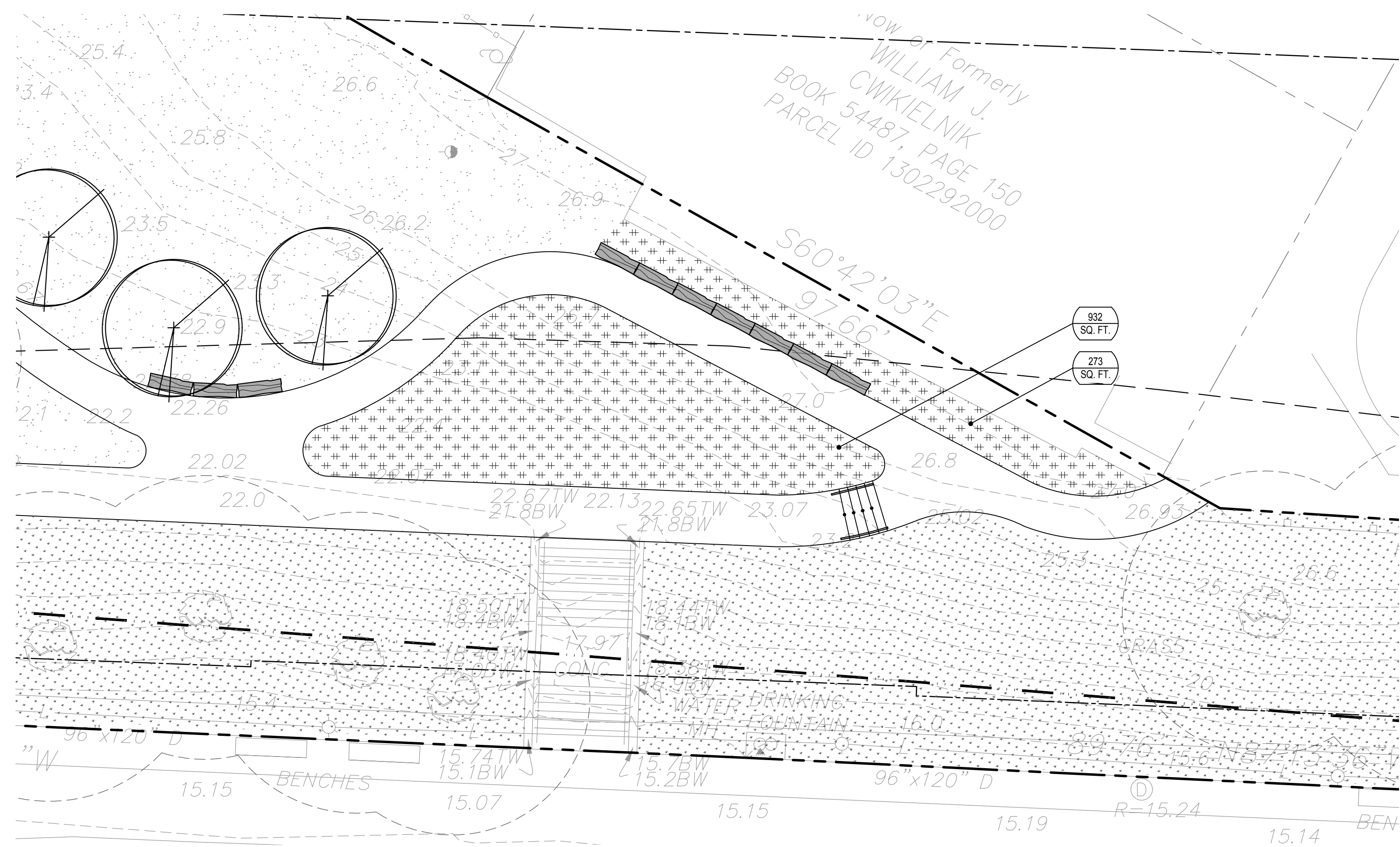

1 SOUTHVIEW STREET ENTRANCE - ENLARGEMENT PLAN
SCALE: 1" = 10'-0"

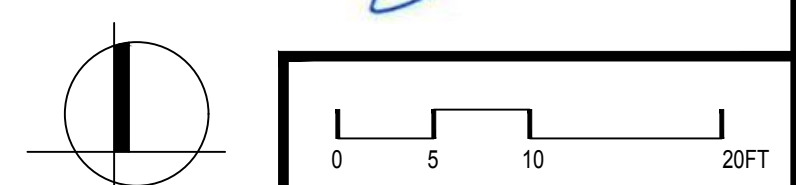

Prepared By:
Weston & Sampson
Consultant Project No. 2160850

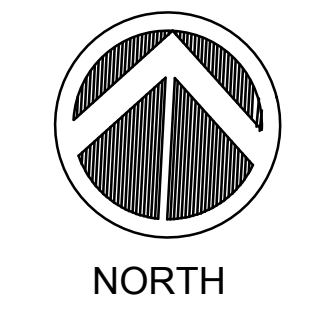

No.	Date	Revision

Approved By: _____ Date: _____

Project Name.:
IMPROVEMENTS TO MCCONNELL PARK

BWSC SUBMISSION
Date: FEBRUARY 2021
Scale: 1" = 20'-0"
Drawn: ENB, LSR
Checked: CFR

Sheet Name.:
PLANTING ENLARGEMENT PLAN

SHEET:
L6.02

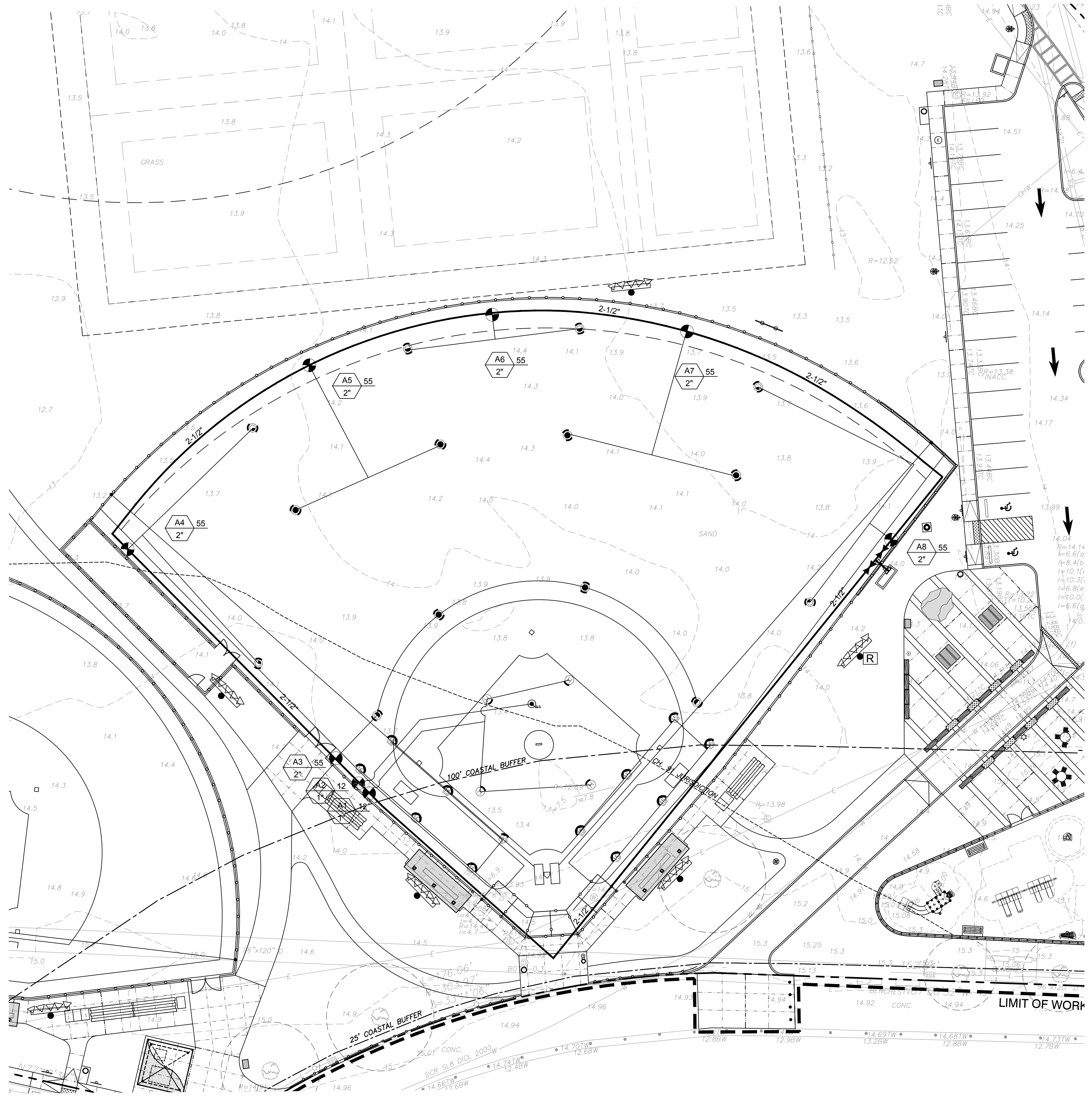

IRRIGATION NOTES

- COORDINATE FINAL LOCATION OF ALL SPRINKLERS AND NOZZLE SELECTION WITH OWNER AND OWNER'S REPRESENTATIVE.
- ALL PIPE AND VALVE LOCATIONS AREA DIAGRAMMATIC. CONTRACTOR SHALL FIELD VERIFY.
- ALL VALVES AND VALVE BOXES SHALL BE PLACED WHERE POSSIBLE IN LAWN AREA OUTSIDE THE LIMITS OF THE LITTLE LEAGUE FIELD AREA OF PLAY AND BELOW WARNING TRACK MIX.
- ALL CONTROL WIRES SHALL BE THROUGH TWO-WIRE COMMUNICATION CABLE.
- QUICK COUPLING VALVES SHALL BE INSTALLED ON 1-INCH PVC SWING JOINT WITH BRASS INSERT AND STABILIZERS (SEE DETAIL).
- ALL SPRAY AND ROTARY SPRINKLERS SHALL BE INSTALLED ON SWING PIPE ASSEMBLIES, MIN. LENGTH TO BE 6-INCH AND 18-INCH MAXIMUM. ALL LARGE ROTARY SPRINKLERS SHALL BE INSTALLED ON 1-INCH PVC PREFABRICATED UNITED SWING JOINT ASSEMBLIES WITH INTEGRAL O-RINGS.
- IRRIGATION SYSTEM IS DESIGNED TO PROVIDE 50 GPM MAXIMUM FROM SYSTEM TO PRODUCE 50-PSI AT POINT OF CONNECTION.
- CONTRACTOR SHALL VERIFY AND TEST DYNAMIC PRESSURE PRIOR TO COMMENCING WORK. REPORT ANY DEVIATION FROM PRESSURE IMMEDIATELY TO OWNER'S REPRESENTATIVE.
- INSTALL CONTROLLER IN PUMP ENCLOSURE OR AS DIRECTED BY OWNER. HARD WIRE TO 120 VOLT, DEDICATED 20 AMP CIRCUIT, ROUTE COMMUNICATION CABLE TO CONTROLLER VIA 1/2-INCH CONDUIT.
- ALL WIRING SHALL BE INSTALLED IN SCHEDULE PVC CONDUIT.
- COORDINATE LOCATION OF ALL EXISTING AND PROPOSED UTILITIES IN SITE AND CONTACT CITY AGENCIES AND UTILITY COMPANIES PRIOR TO START OF WORK.
- SPRAY SPRINKLER FOR TURF SHALL HAVE 4-INCH POP UP HEIGHT.
- CONTRACTOR MUST PROVIDE PRODUCT SUBMITTALS IN ACCORDANCE WITH PLANS AND SPECIFICATIONS FOR APPROVAL PRIOR TO STARTING WORK. ONCE SUBMITTAL HAVE BEEN APPROVED, WORK MY BEGIN.
- SEE IRRIGATION DETAILS AND SPECIFICATIONS FOR ADDITIONAL NECESSARY INFORMATION.
- CONTRACTOR SHALL PROVIDE 2 (TWO) TOTAL SCHEDULE 80 PVC SLEEVES AT EACH LATERAL OR MAINLINE CROSSING BELOW PAVEMENT, TYPICAL. SLEEVE DIAMETER SHALL BE 2X DIAMETER OF IRRIGATION PIPE SIZE.
- ALL MAINTENANCE AND LATERAL LINES SHALL BE MARKED.
- AS THESE PLANS ARE DIAGRAMMATIC, CONTRACTOR MUST MODIFY LAYOUT AND LOCATION AS NECESSARY TO PROVIDE 100% GUARANTEED COVERAGE IN ALL AREAS TO RECEIVE IRRIGATION.
- INSTALL RAIN SENSOR ON SPORT LIGHT POLE FIXTURE OR AS DIRECTED BY OWNER. EXTERIOR RAIN SENSOR WIRING SHALL BE INSTALLED 3/4-INCH RIGID METAL CONDUIT, SECURED TO POLE FIXTURE.

LEGEND

- LIMIT OF WORK
- PROPERTY LINE
- - - LAND SUBJECT TO COASTAL STORM FLOWAGE - ZONE AE
- 100' COASTAL BUFFER
- 25' COASTAL BUFFER

IRRIGATION PIPE TABLE

- | SYMBOL | PIPE |
|--------|--|
| --- | 200 PSI SCHEDULE 40 PVC PIPE, LATERALS |
| --- | 2-1/2" 200 PSI SDR 21 PVC PIPE, MAIN LINE |
| --- | 4" 200 PSI SCHEDULE 80 PVC PIPE, SLEEVES |
| ⊗ | ISOLATION GATE VALVE (3-INCH) |
| ⊗ | ISOLATION GATE VALVE (2-1/2-INCH OR SMALLER) |

IRRIGATION EQUIPMENT TABLE

- | Symbol | EQUIPMENT |
|--------|-----------------------------------|
| ⊗ | HUNTER ICV-151G 1-1/2" ZONE VALVE |
| ⊗ | 1" QUICK COUPLER VALVE |
| A | AUTOMATIC CONTROLLER |
| R | AUTOMATIC RAIN SENSOR |
| ⊗ | HOSE BIB |

IRRIGATION HEADS TABLE

- | SYMBOL | SPRINKLER HEADS |
|--------|------------------------------|
| ⊗ | HUNTER I-25-04-SS-13 ROTORS |
| ⊗ | HUNTER I-25-04-SS-13 ROTORS |
| ⊗ | HUNTER PROS-04-CV-15A SPRAYS |

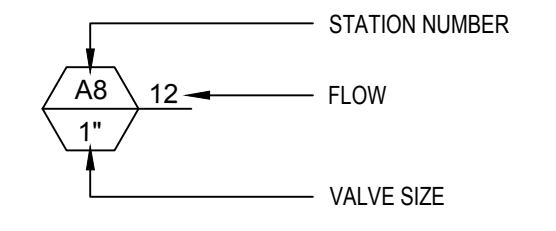

FLOW SCHEDULE	
GPM	PIPE SIZE / TYPE
0 - 12	1-INCH 100 PSI POLYETHYLENE OR CLASS 200
12 - 22	1-1/4-INCH 100 PSI POLYETHYLENE OR CLASS 200
23 - 35	1-1/2-INCH CLASS 200 PVC
36 - 55	2-INCH CLASS 200 PVC
56 - 85	2-1/2-INCH CLASS 200 PVC
86 - 120	3-INCH CLASS 200 PVC
121 - 200	4-INCH CLASS 200 PVC

1 LITTLE LEAGUE FIELD IRRIGATION PLAN
SCALE: 1" = 20'-0"

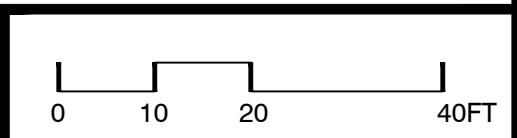
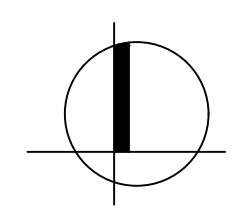

	Prepared By:		No.	Date	Revision	Project Name.: IMPROVEMENTS TO McCONNELL PARK	Date	FEBRUARY 2021	Sheet Name.: IRRIGATION PLAN	IR1.00
			Approved By:	Date:	Scale		AS SHOWN	Drawn		

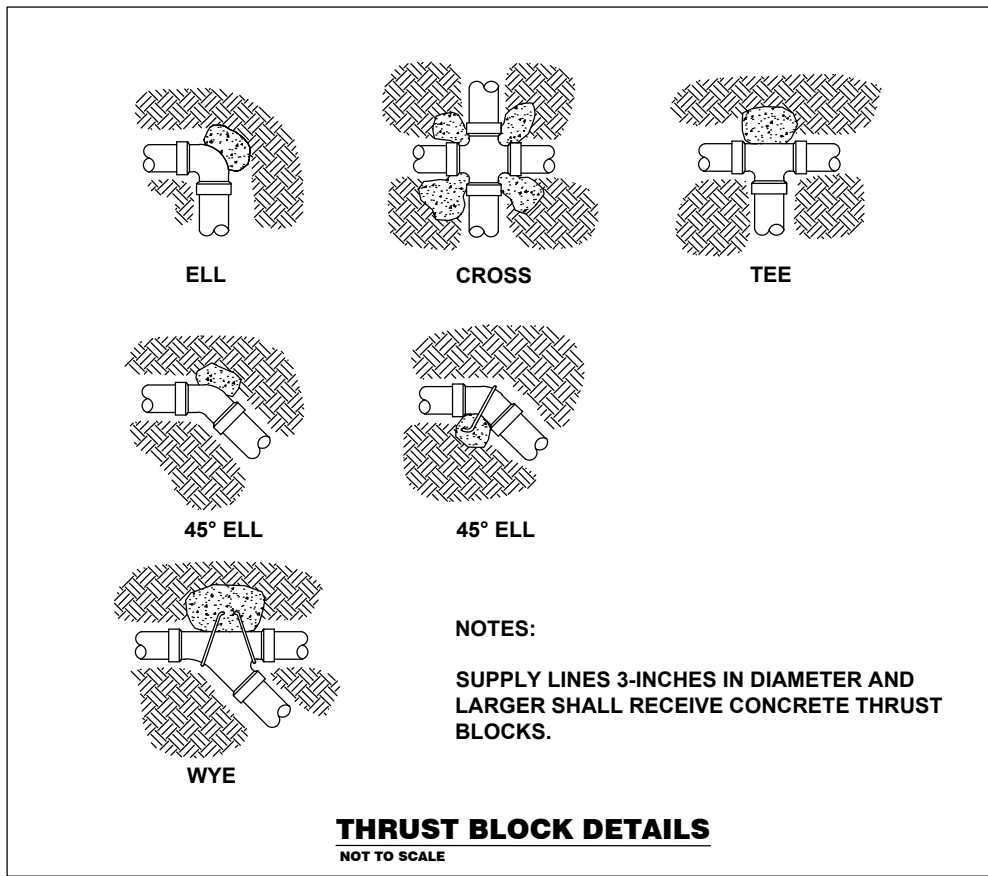
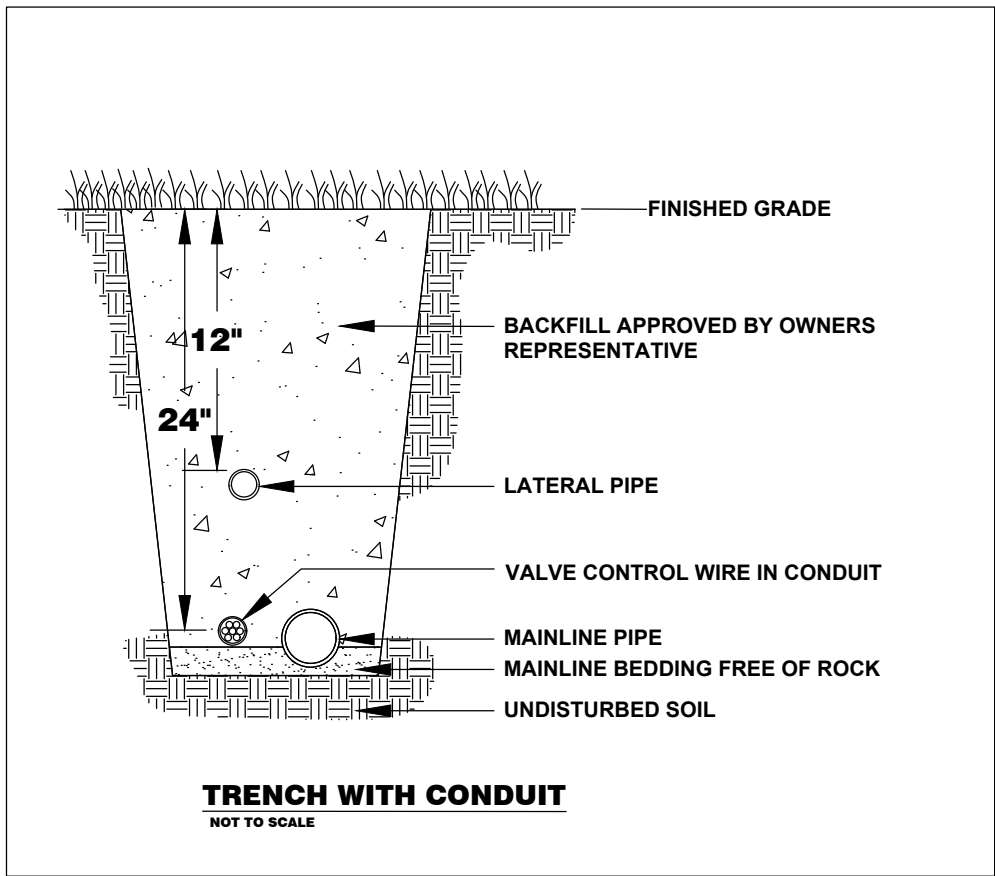
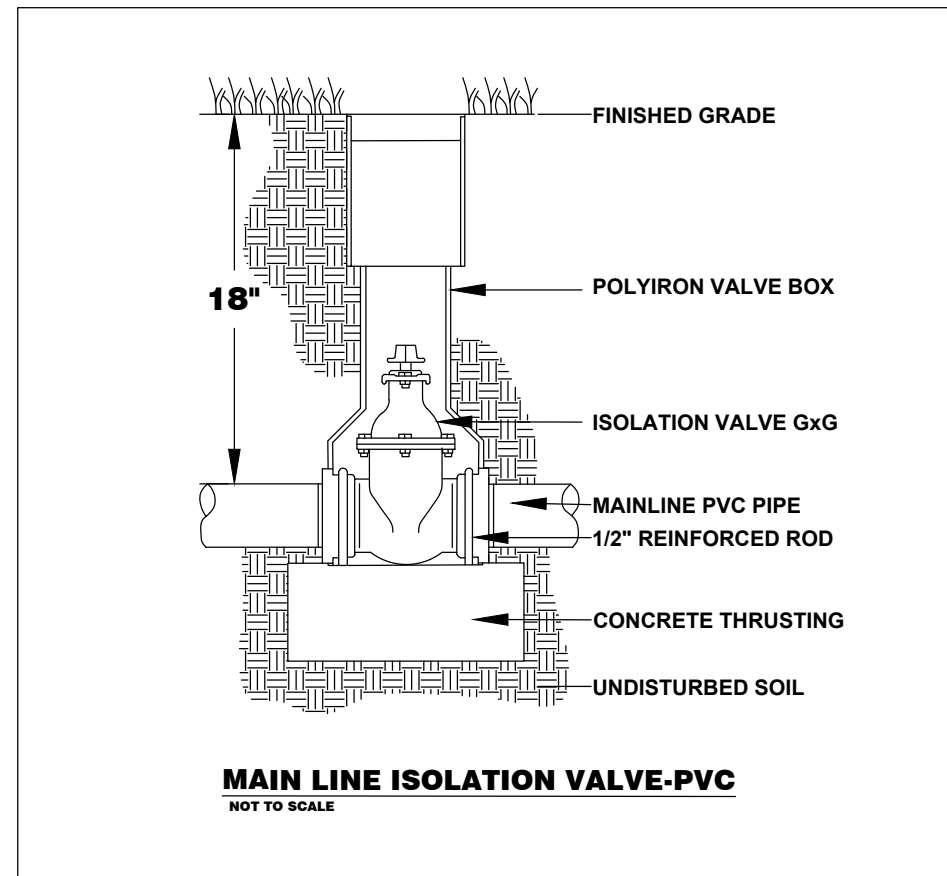
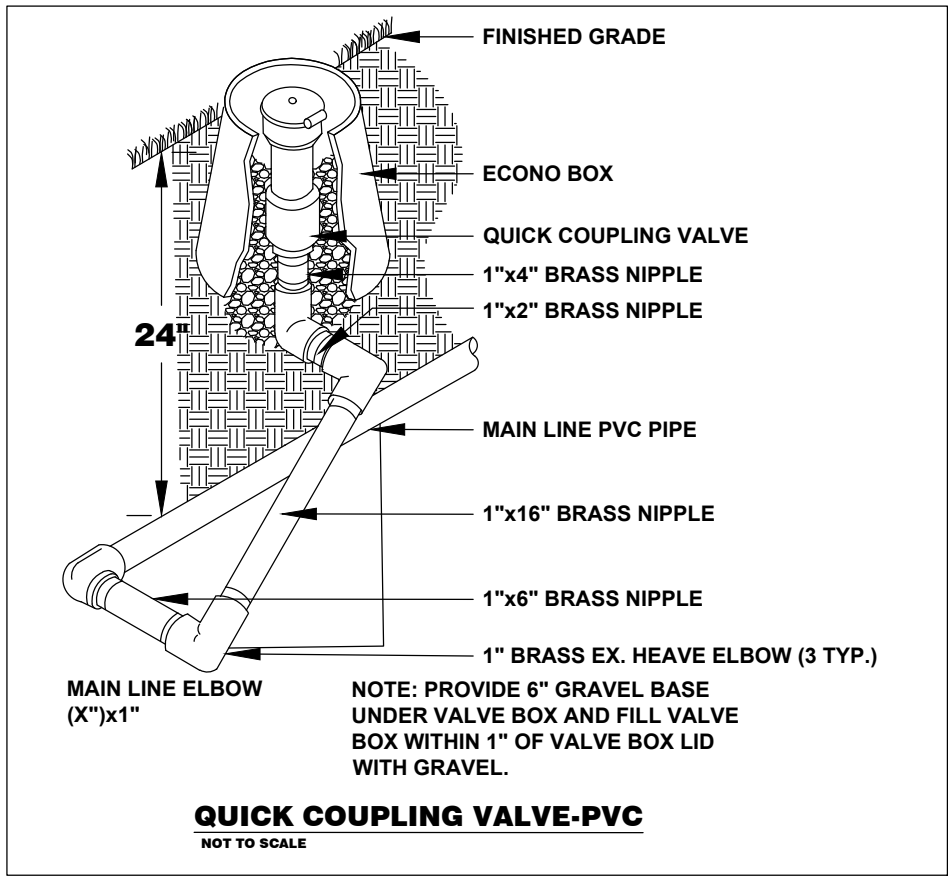
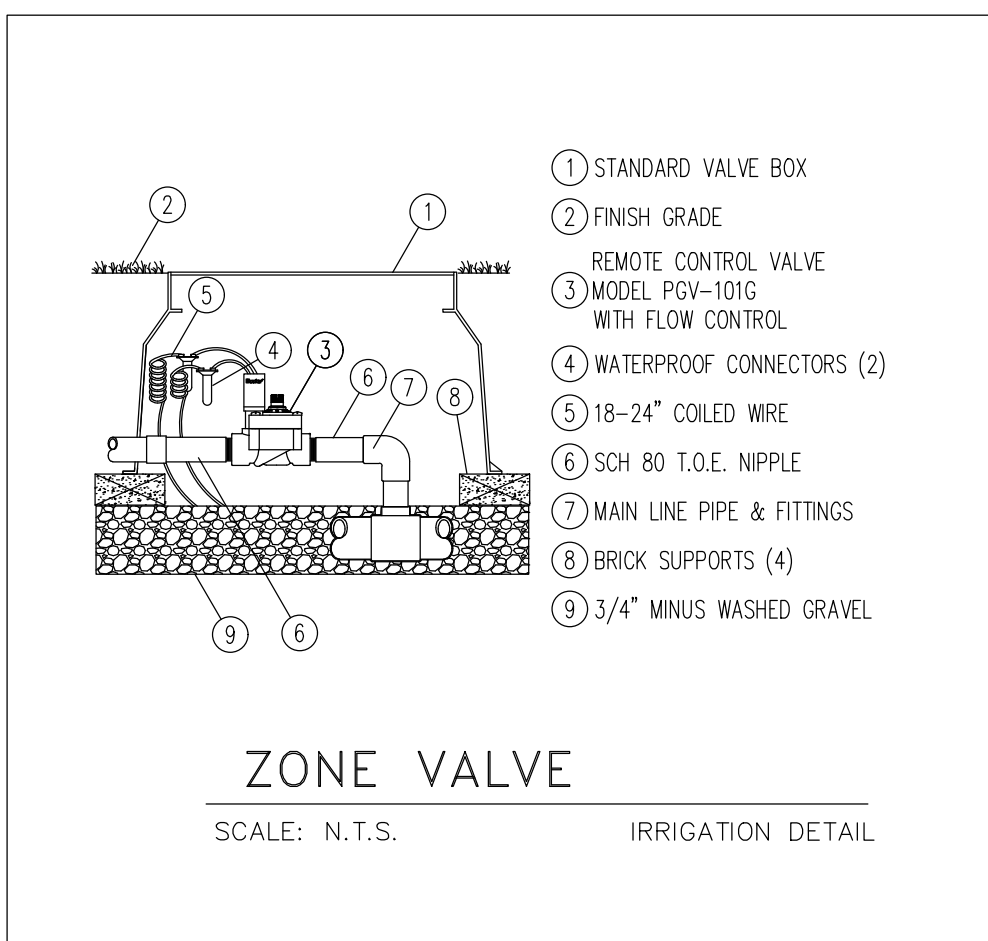
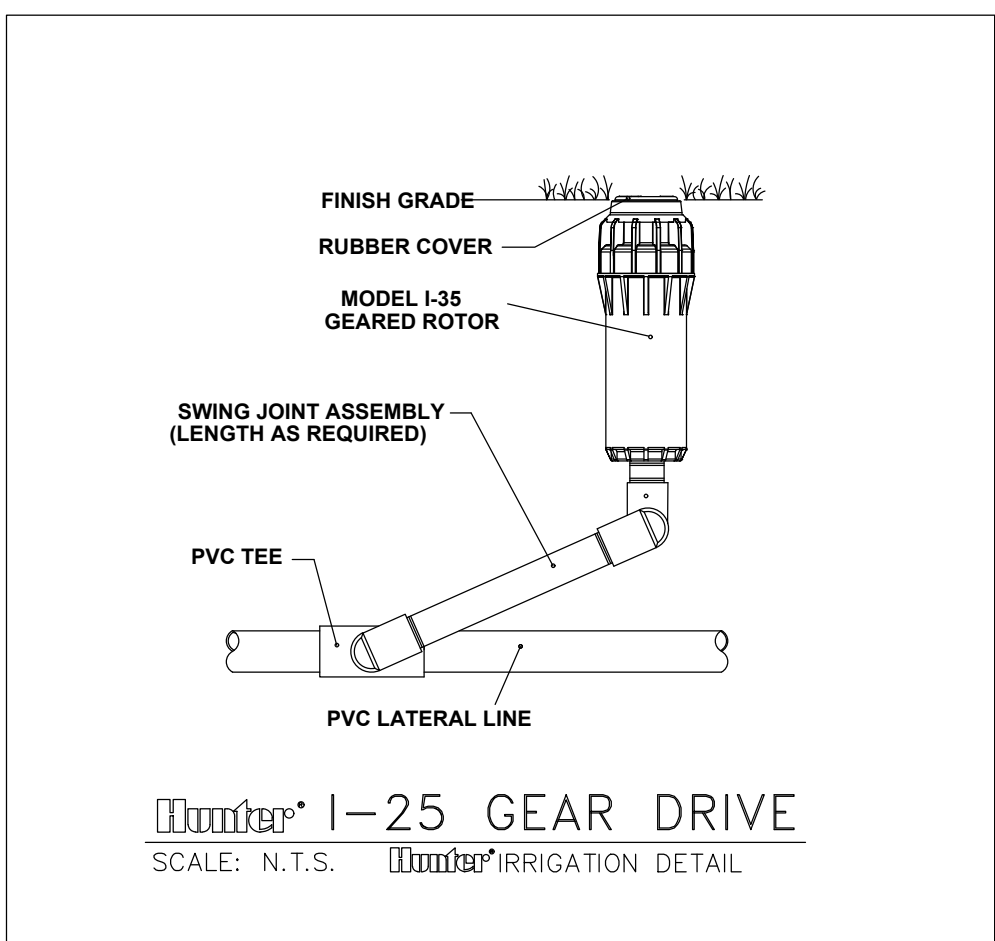

Prepared By:
Weston & Sampson
Consultant Project No. 2160850



No.	Date	Revision

Approved By: _____ Date: _____

Project Name.:
**IMPROVEMENTS TO
McCONNELL PARK**

BWSC SUBMISSION
Date: FEBRUARY 2021
Scale: AS SHOWN
Drawn: ENB, LSR
Checked: CFR

Sheet Name.:
IRRIGATION DETAILS

SHEET:
IR2.00

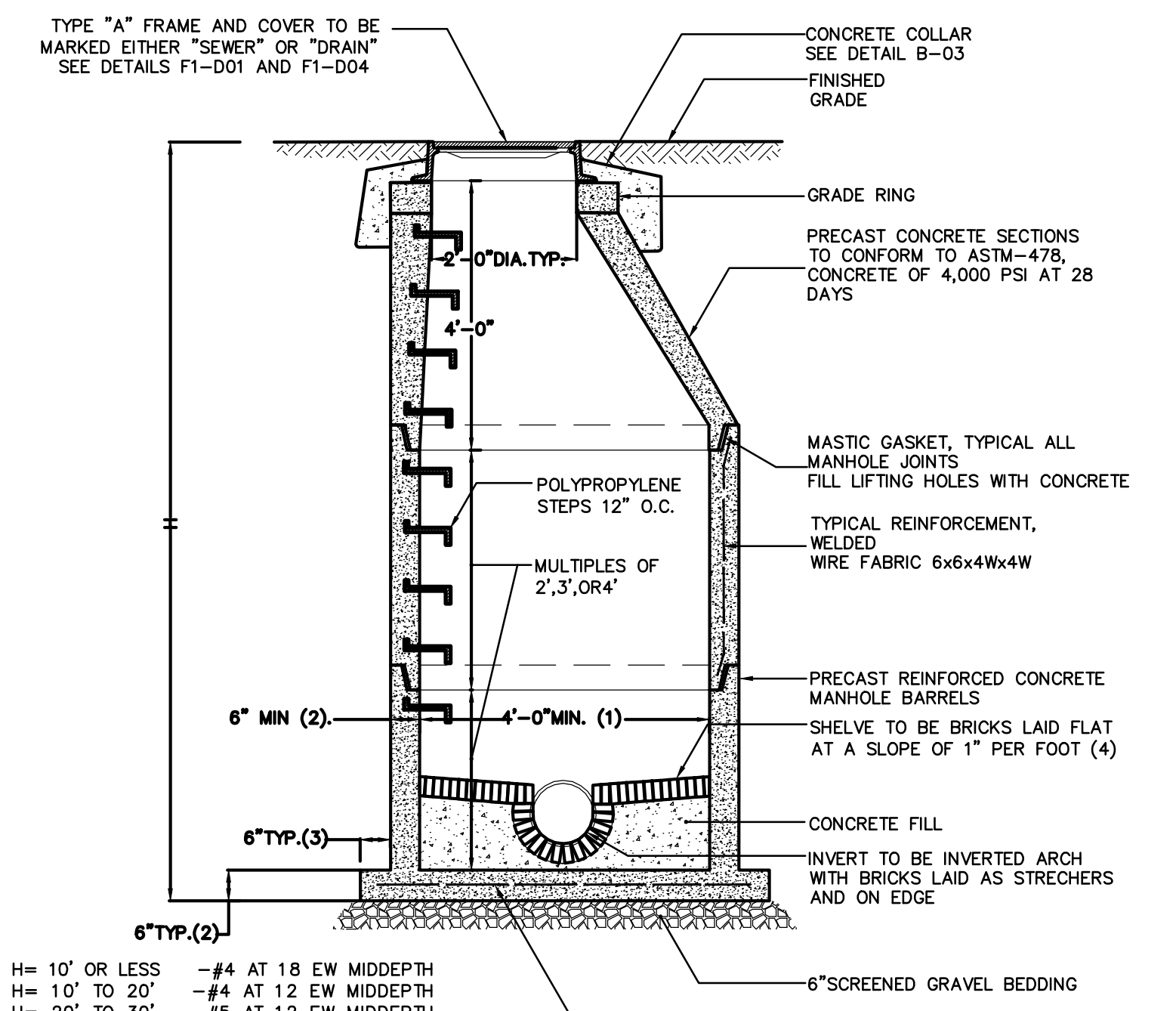

TYPE "A" FRAME AND COVER TO BE MARKED EITHER "SEWER" OR "DRAIN" SEE DETAILS F1-D01 AND F1-D04

CONCRETE COLLAR SEE DETAIL B-03 FINISHED GRADE

GRADE RING

PRECAST CONCRETE SECTIONS TO CONFORM TO ASTM-478, CONCRETE OF 4,000 PSI AT 28 DAYS

MASTIC GASKET, TYPICAL ALL MANHOLE JOINTS

POLYPROPYLENE STEPS 12" O.C.

MULTIPLES OF 2', 3', OR 4'

PRECAST REINFORCED CONCRETE MANHOLE BARRELS

SHELVE TO BE BRICKS LAID FLAT AT A SLOPE OF 1" PER FOOT (4)

CONCRETE FILL

INVERT TO BE INVERTED ARCH WITH BRICKS LAID AS STRECHERS AND ON EDGE

6" SCREENED GRAVEL BEDDING

H= 10' OR LESS -#4 AT 18 EW MIDDDEPTH
 H= 10' TO 20' -#4 AT 12 EW MIDDDEPTH
 H= 20' TO 30' -#5 AT 12 EW MIDDDEPTH
 IN ADDITION TO WELDED WIRE FABRIC

NOTES:
 1. 5'-0" DIAMETER FOR ALL MANHOLE DEPTHS GREATER THAN 20 FEET OR WHEN ORDERED BY THE ENGINEER
 2. 6" MIN. WALL THICKNESS AND 7" INCH MIN. BASE THICKNESS WITH 5'-0" DIAMETER MANHOLES
 3. 6" INCH LIP OPTIONAL UNLESS OTHERWISE NOTED
 4. CONCRETE INVERT AND SHELVE MAY BE SUBSTITUTED IN STORM DRAIN MANHOLES AS DIRECTED BY THE ENGINEER

1 BWSC TYPICAL PRECAST CONCRETE MANHOLE
SCALE: N.T.S.

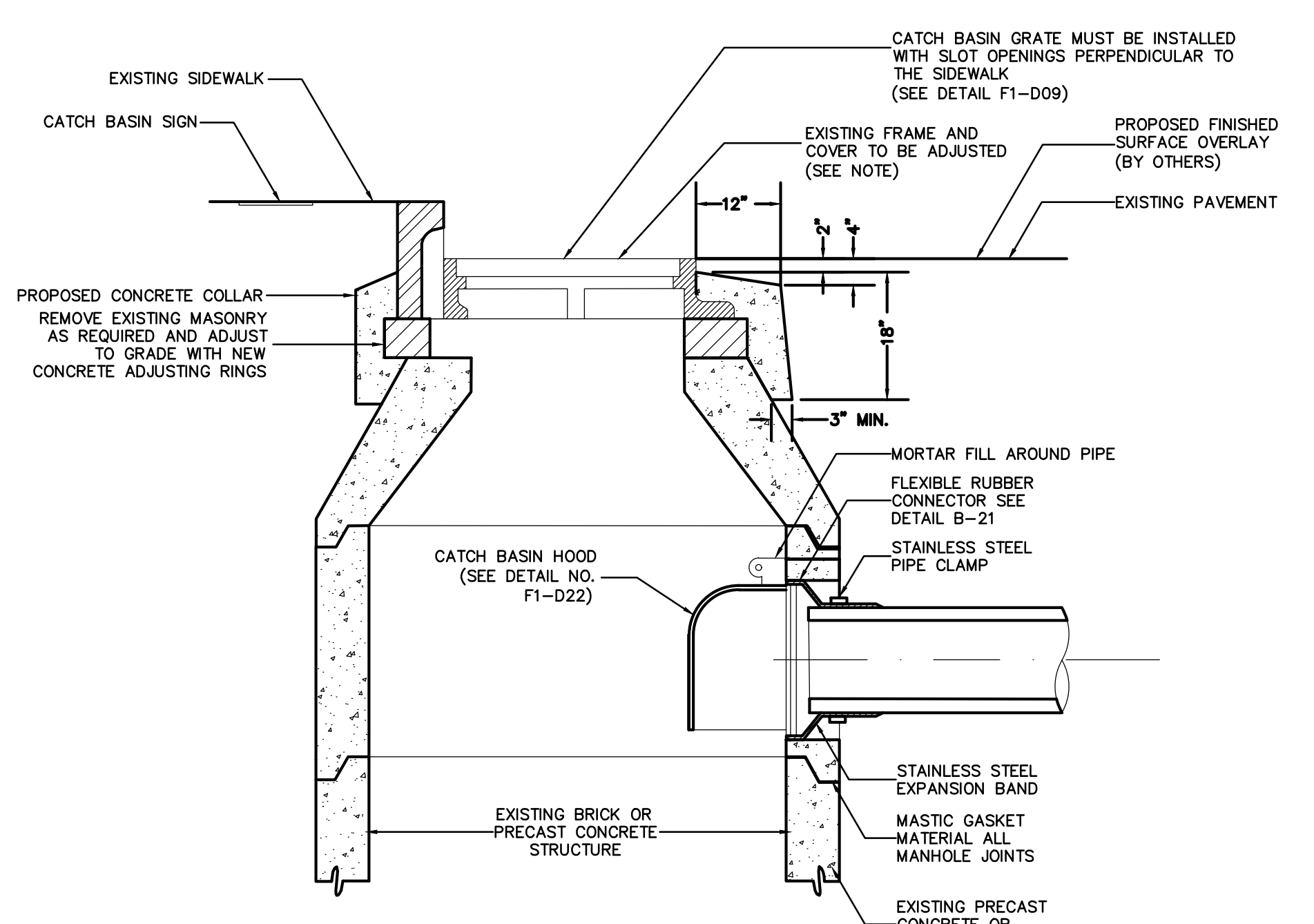

CATCH BASIN GRATE MUST BE INSTALLED WITH SLOT OPENINGS PERPENDICULAR TO THE SIDEWALK (SEE DETAIL F1-D09)

PROPOSED FINISHED SURFACE OVERLAY (BY OTHERS)

EXISTING PAVEMENT

EXISTING FRAME AND COVER TO BE ADJUSTED (SEE NOTE)

12"

12"

3" MIN.

48" MIN. SUMP

MORTAR FILL AROUND PIPE

FLEXIBLE RUBBER CONNECTOR SEE DETAIL B-21

STAINLESS STEEL PIPE CLAMP

STAINLESS STEEL EXPANSION BAND

MASTIC GASKET MATERIAL ALL MANHOLE JOINTS

EXISTING PRECAST CONCRETE OR BRICK STRUCTURE

CATCH BASIN HOOD (SEE DETAIL NO. F1-D22)

EXISTING BRICK OR PRECAST CONCRETE STRUCTURE

EXISTING SIDEWALK

CATCH BASIN SIGN

PROPOSED CONCRETE COLLAR REMOVE EXISTING MASONRY AS REQUIRED AND ADJUST TO GRADE WITH NEW CONCRETE ADJUSTING RINGS

NOTE:
 OVERLAY BY OTHERS WILL BE 1-1/4" AT CENTERLINE TAPERING TO 1" AT CURBLINE

2 BWSC CATCH BASIN ADJUSTMENT TO GRADE
SCALE: N.T.S.

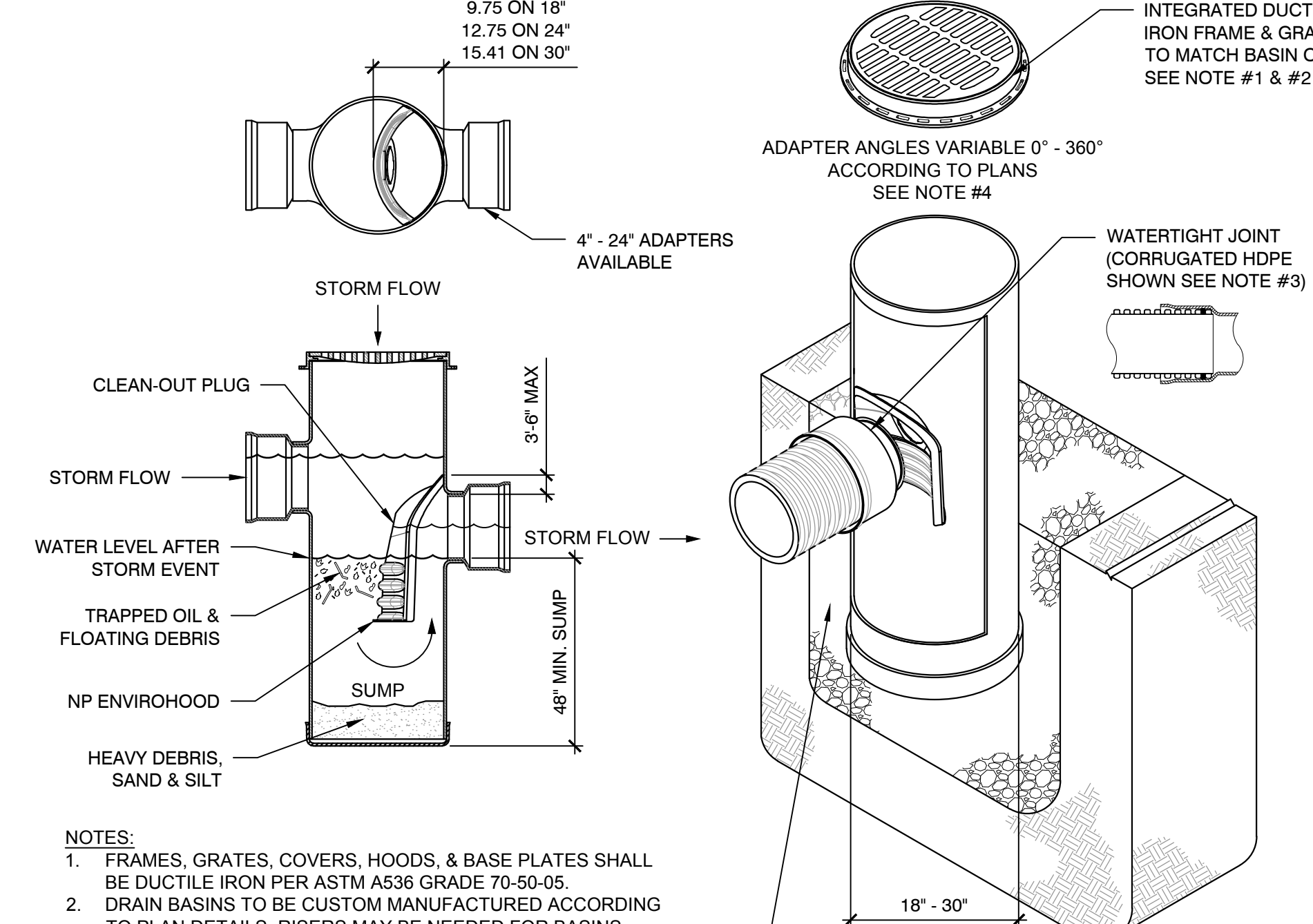

INTEGRATED DUCTILE IRON FRAME & GRATE TO MATCH BASIN O.D. SEE NOTE #1 & #2

ADAPTER ANGLES VARIABLE 0° - 360° ACCORDING TO PLANS SEE NOTE #4

WATERTIGHT JOINT (CORRUGATED HDPE SHOWN SEE NOTE #3)

STORM FLOW

CLEAN-OUT PLUG

STORM FLOW

WATER LEVEL AFTER STORM EVENT

TRAPPED OIL & FLOATING DEBRIS

NP ENVIROHOOD

HEAVY DEBRIS, SAND & SILT

SUMP

STORM FLOW

9.75 ON 18"
12.75 ON 24"
15.41 ON 30"

4" - 24" ADAPTERS AVAILABLE

3'-6" MAX

48" MIN. SUMP

NOTES:
 1. FRAMES, GRATES, COVERS, HOODS, & BASE PLATES SHALL BE DUCTILE IRON PER ASTM A536 GRADE 70-50-05.
 2. DRAIN BASINS TO BE CUSTOM MANUFACTURED ACCORDING TO PLAN DETAILS. RISERS MAY BE NEEDED FOR BASINS OVER 84". REFER TO MANUFACTURER'S SPECIFICATIONS.
 3. DRAINAGE CONNECTION STUB JOINT TIGHTNESS SHALL CONFORM TO ASTM D3212 FOR CORRUGATED HDPE (ADS N-12/HANCOR DUAL WALL), N-12 HP, & PVC SEWER (4" - 18").
 4. ADAPTERS CAN BE MOUNTED ON ANY ANGLE 0° TO 360°. TO DETERMINE MINIMUM ANGLE BETWEEN ADAPTERS, REFER TO MANUFACTURER'S SPECIFICATIONS.

THE BACKFILL MATERIAL SHALL BE DENSE GRADED CRUSHED STONE OR OTHER GRANULAR MATERIAL MEETING THE REQUIREMENTS OF CLASS I OR II MATERIAL AS DEFINED IN ASTM D2321. BEDDING & BACKFILL FOR SURFACE DRAINAGE INLETS SHALL BE PLACED & COMPACTED UNIFORMLY IN ACCORDANCE WITH ASTM D2321.

3 PVC DEEP SUMP CATCH BASIN WITH HOOD
SCALE: N.T.S.

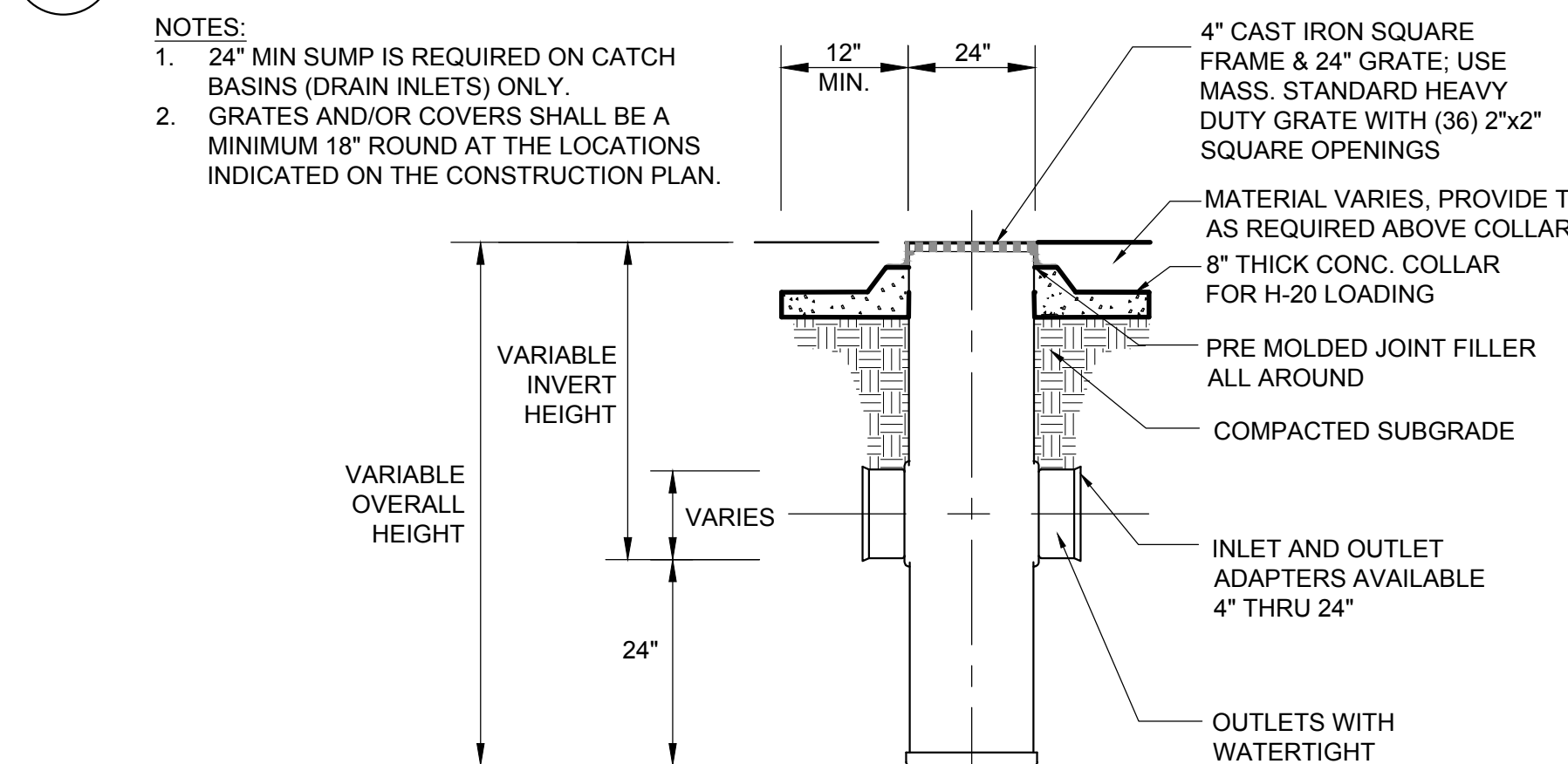

4 PVC AREA DRAIN
SCALE: N.T.S.

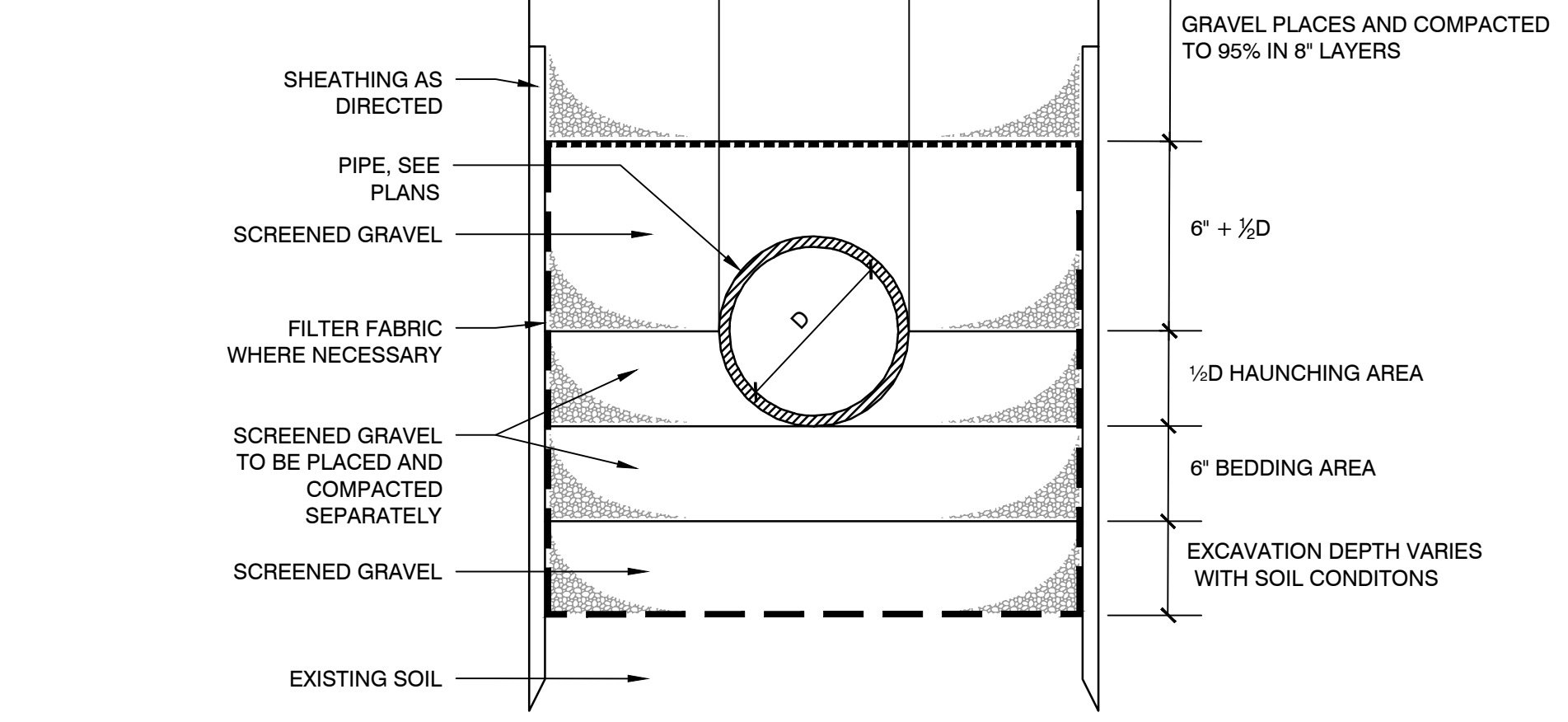

5 BWSC DRAINAGE TRENCH
SCALE: N.T.S.

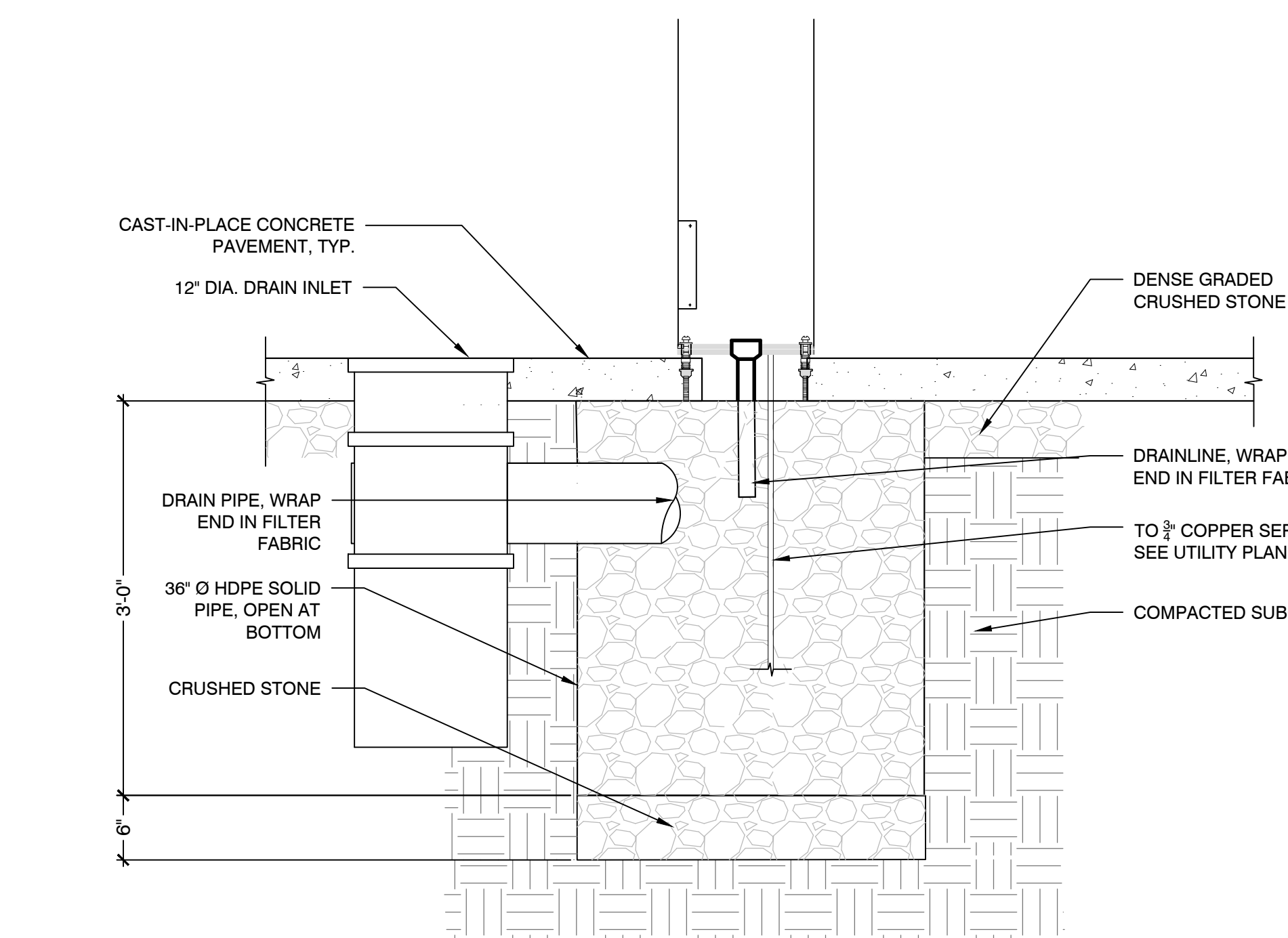

9 DRINKING FOUNTAIN
SCALE: N.T.S.

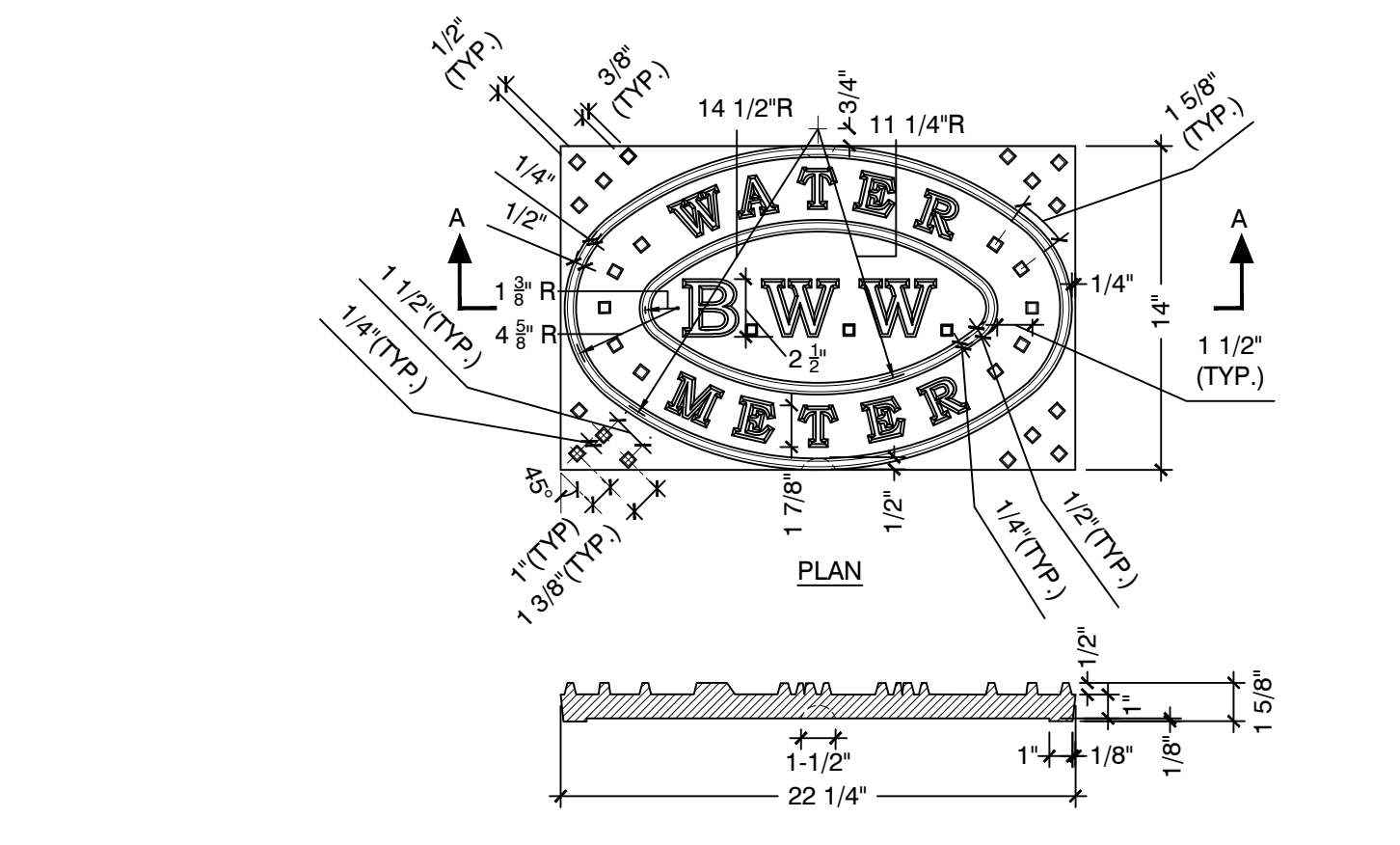

SECTION A-A

NOTE:
 1. ALL CASTING SHALL BE MANUFACTURED FROM GRAY IRON CONFORMING TO ASTM A48 CLASS 35B AND/OR AASHTO M105 CLASS 35B.

6 HEAVY METER COVER - BWSC STANDARD
SCALE: N.T.S.

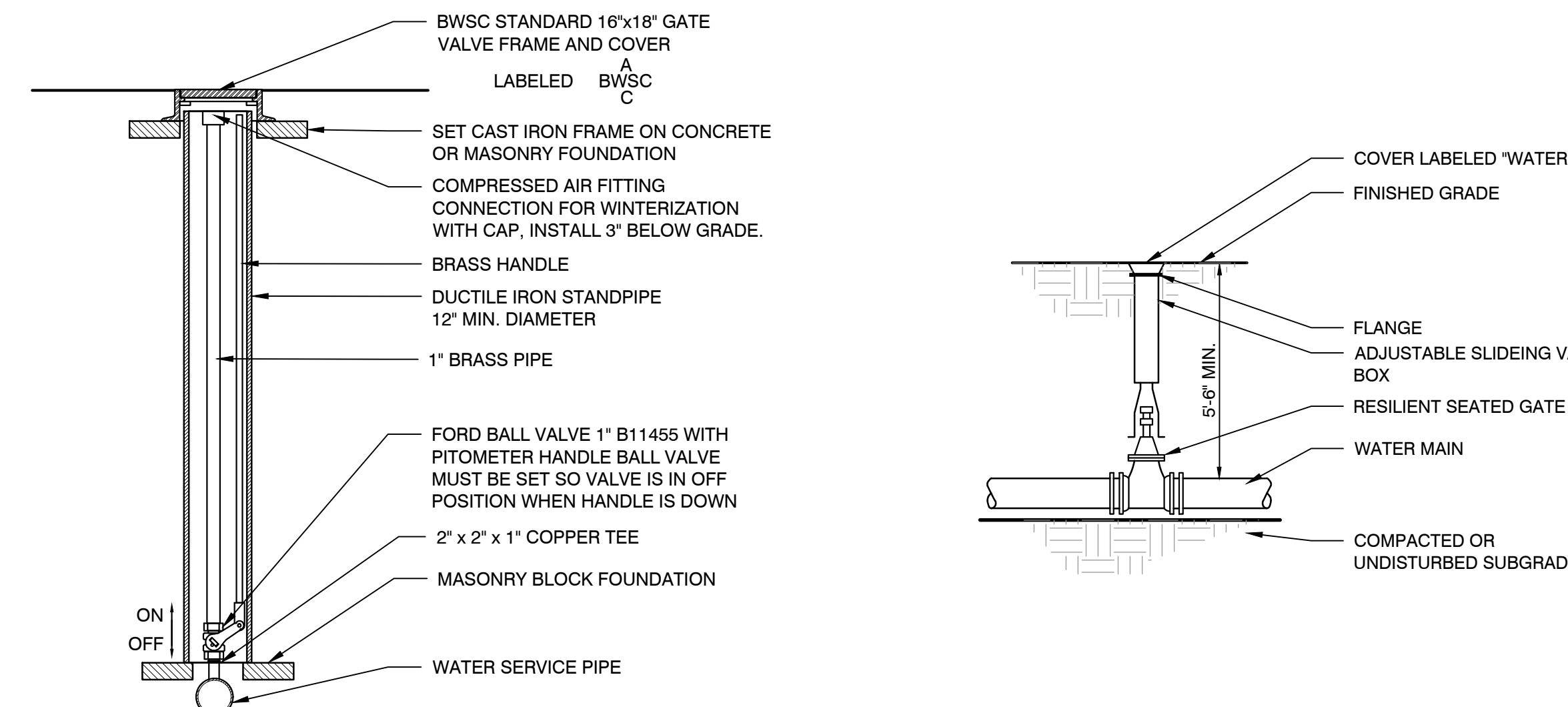

7 PIPE WINTERIZATION BLOW OUT STRUCTURE
SCALE: N.T.S.

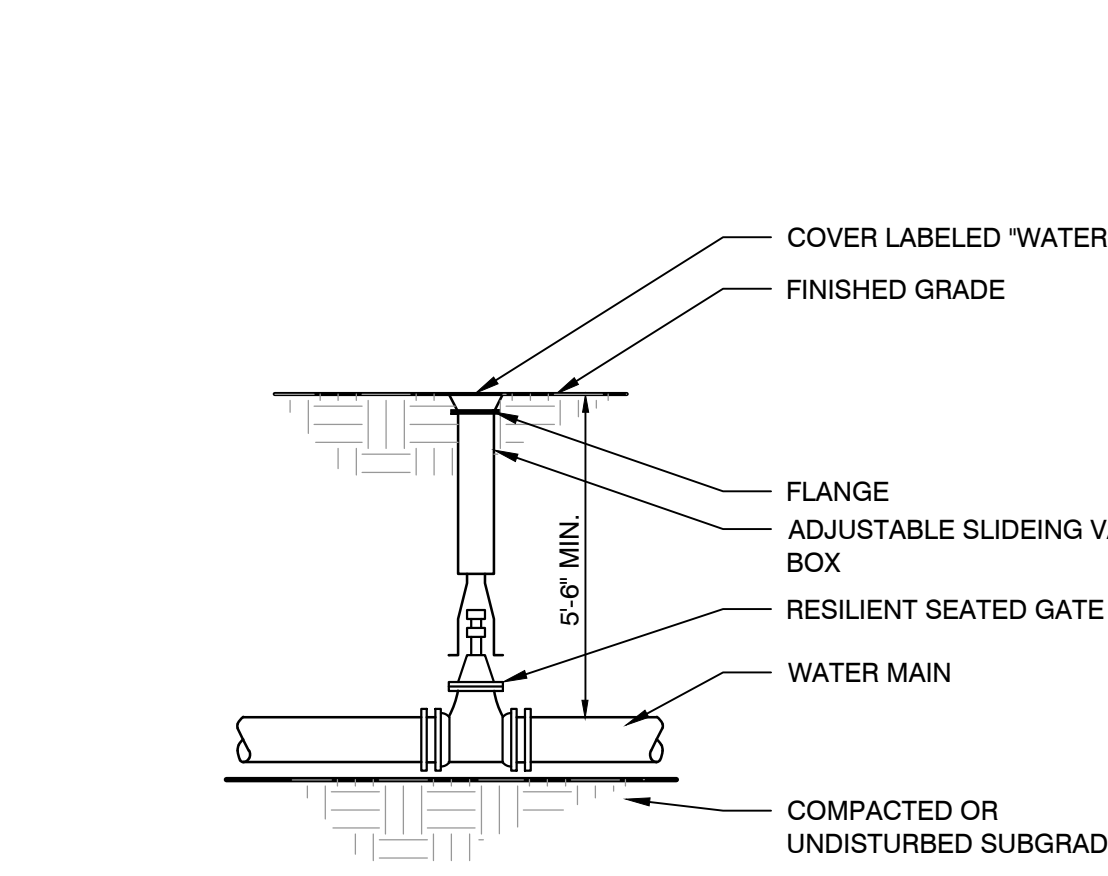

8 WATER VALVE
SCALE: N.T.S.

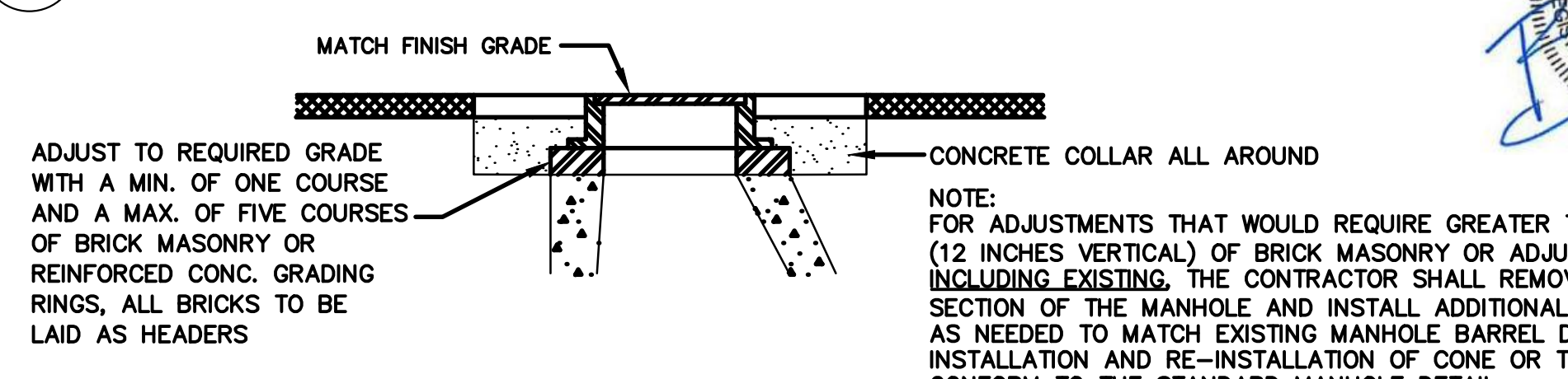

10 MANHOLE FRAME AND COVER ADJUSTMENT
SCALE: N.T.S.

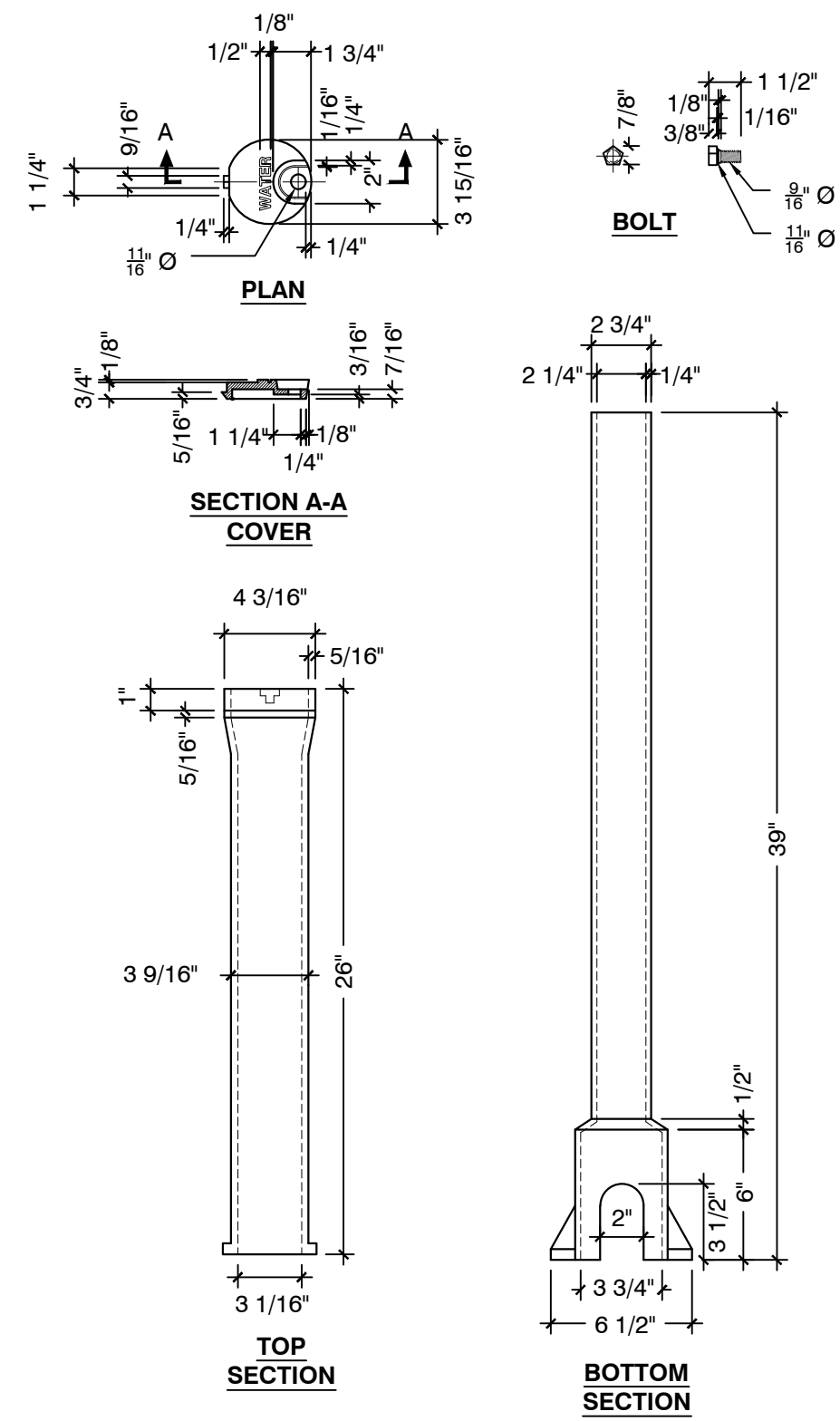

ITEM	NUMBER
COVER	99602000
TOP SECTION	99602001
BOTTOM SECTION	99602002
BOLT ONLY	99602003

NOTE:
1. ALL CASTINGS SHALL BE MANUFACTURED FROM GRAY IRON CONFORMING TO ASTM A48 CLASS 35B AND/OR AASHTO M105 CLASS 35B.

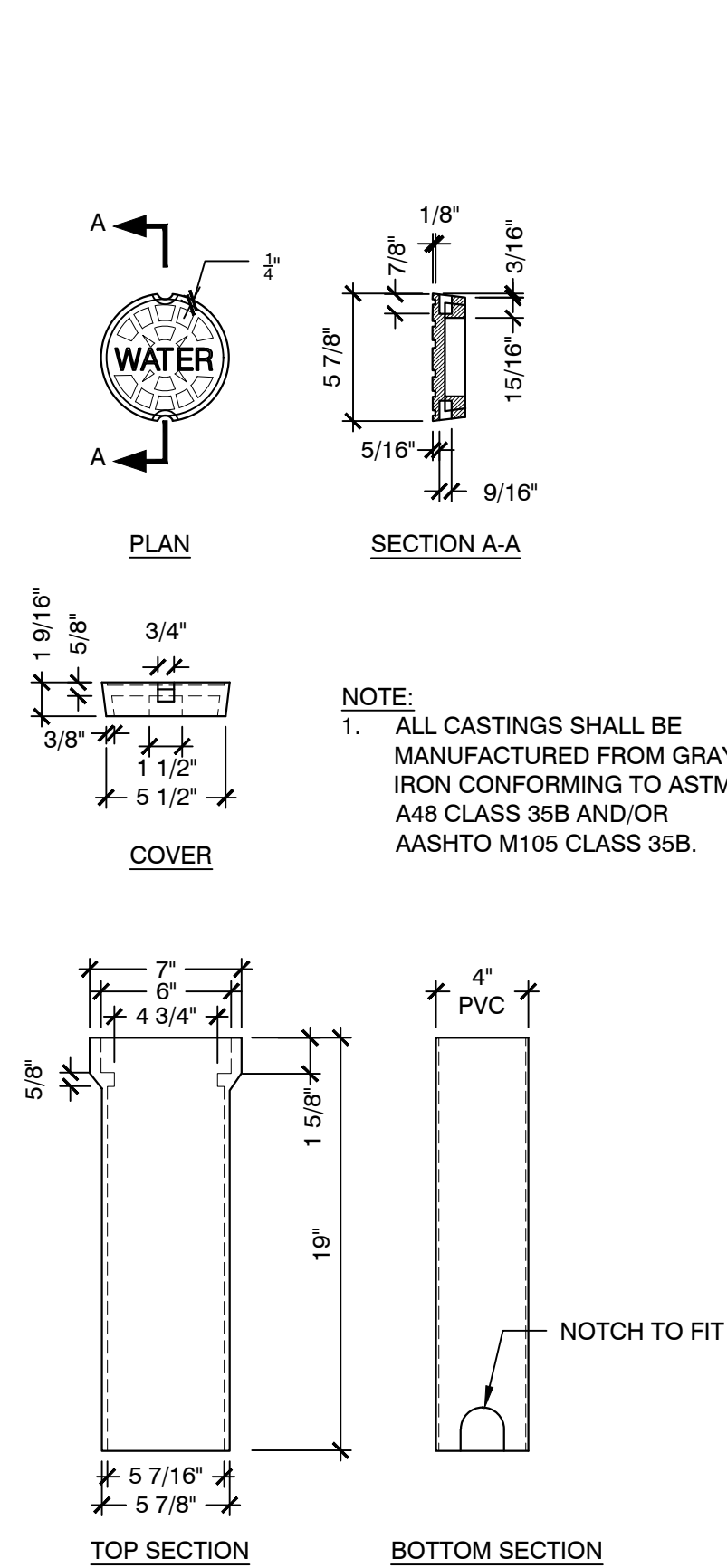

ITEM	NUMBER
COVER	99460000
TOP SECTION	99460001

NOTE:
1. ALL CASTINGS SHALL BE MANUFACTURED FROM GRAY IRON CONFORMING TO ASTM A48 CLASS 35B AND/OR AASHTO M105 CLASS 35B.

3 FLARED END PIPE
SCALE: N.T.S.

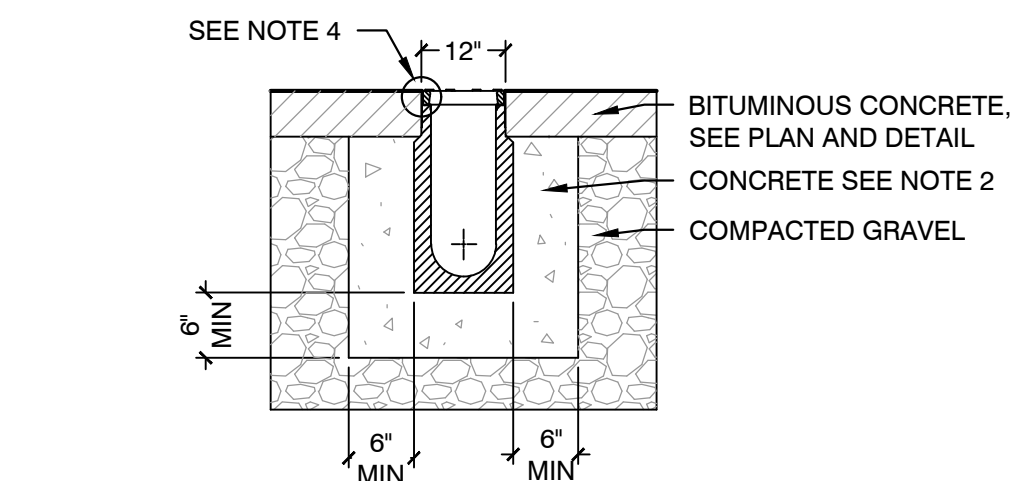
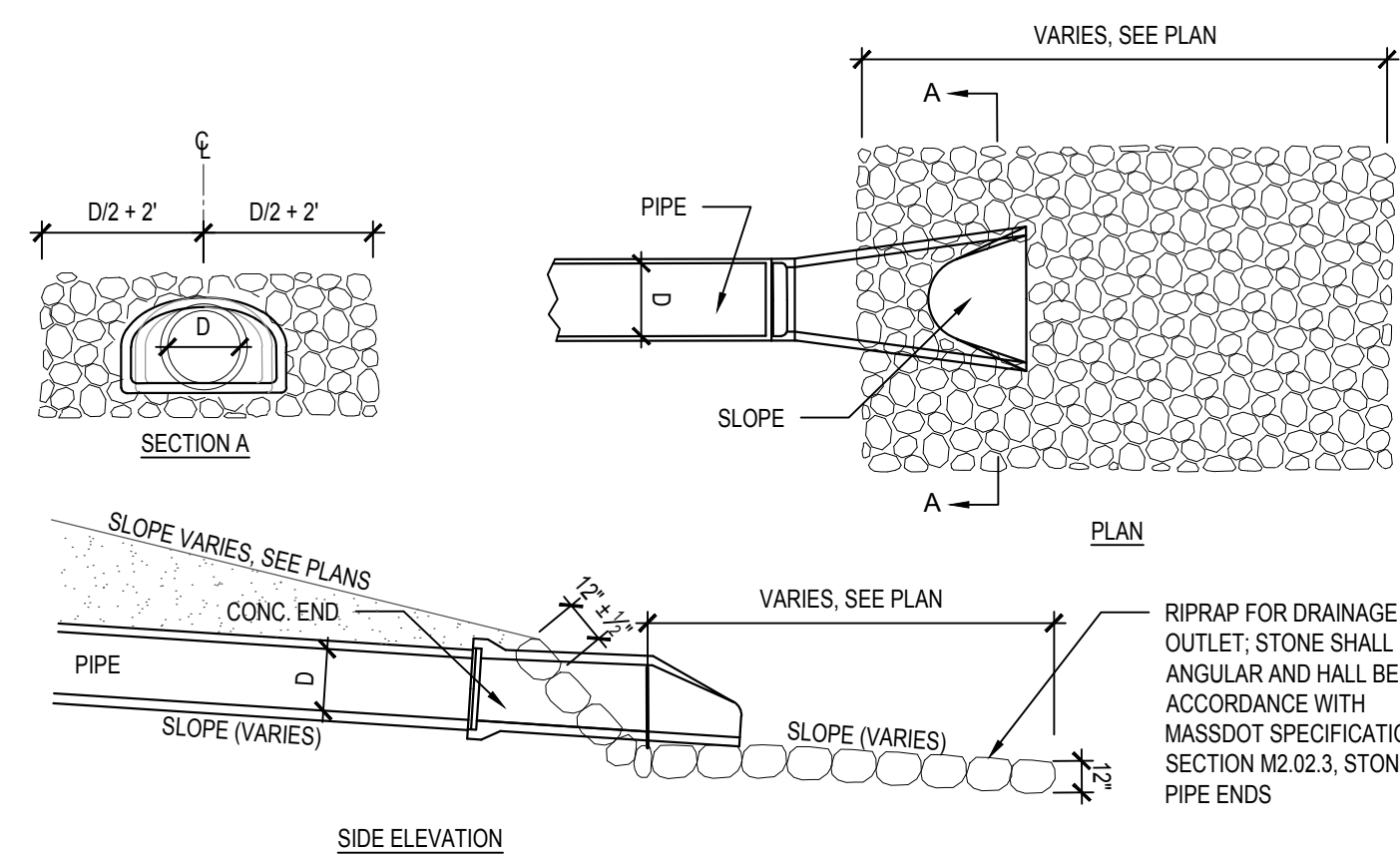

NOTES:
1. CONTRACTOR TO ENSURE THE MINIMUM DIMENSIONS SHOWN ARE SUITABLE FOR THE EXISTING GROUND CONDITIONS. NOTIFY THE ENGINEER OF ANY DISCREPANCIES.
2. MINIMUM CONCRETE STRENGTH OF 3000 PSI. THE CONCRETE SHALL BE VIBRATED TO ELIMINATE AIR POCKETS.
3. THE FINISHED LEVEL OF THE CONCRETE SURROUND MUST BE APPROX. 1/8" ABOVE THE TOP OF THE CHANNEL EDGE.
4. TRENCH DRAIN SHALL BE MANUFACTURED BY ACO OR APPROVED EQUAL. REFER TO MANUFACTURER'S LATEST INSTALLATION INSTRUCTIONS FOR COMPLETE DETAILS.

4 TRENCH DRAIN
SCALE: N.T.S.

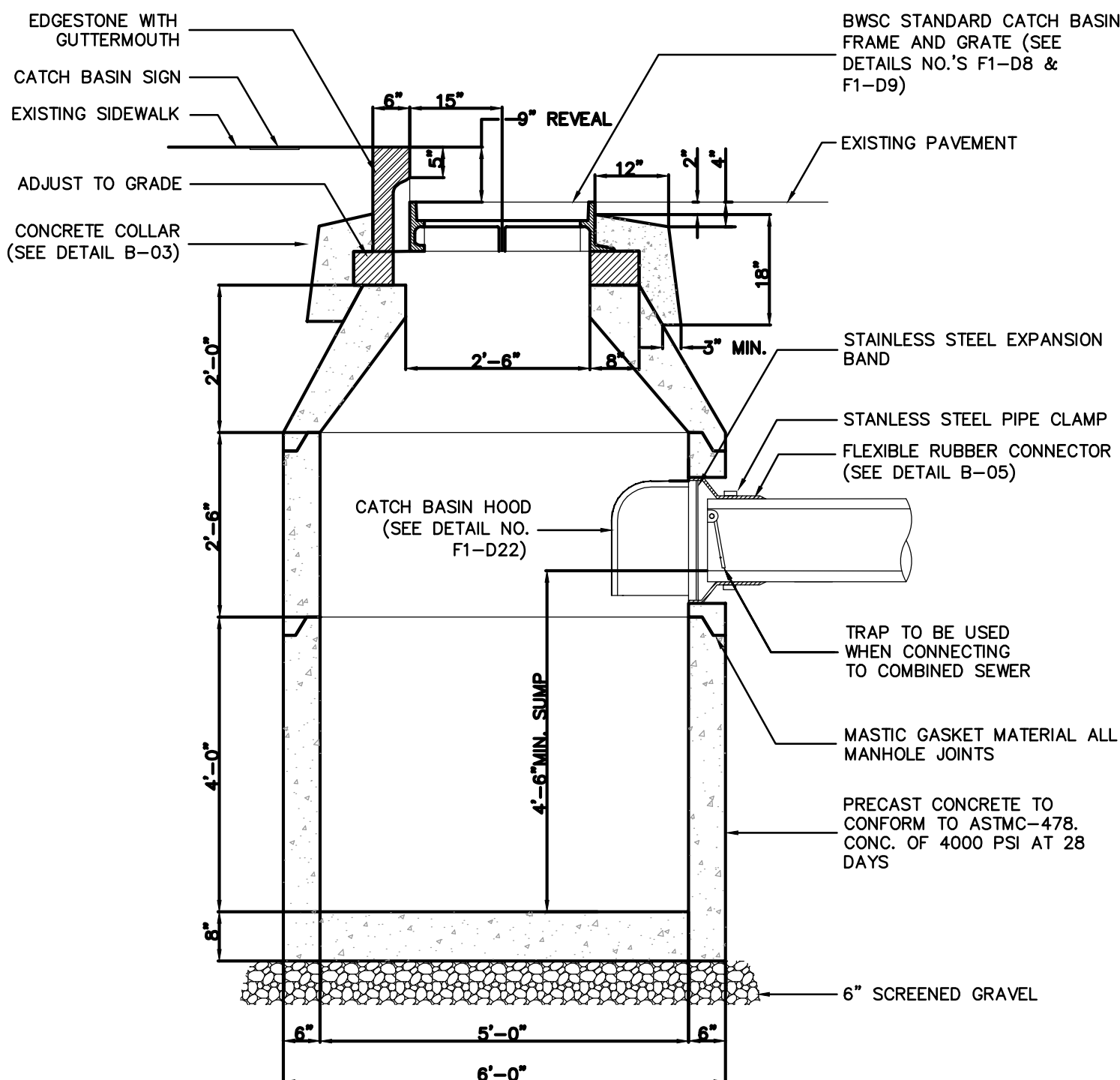

BWSC STANDARD EDGESTONE GUTTERMOUTH IS (72" L X 6" W X 18" H) WITH 3" RADIUS INLET THROAT ROUNDING. MINIMUM WIDTH IS 6". ALL OTHER DIMENSIONS TOLERANCES TO ±1".

7 BWSC STANDARD CATCH BASIN
SCALE: N.T.S.

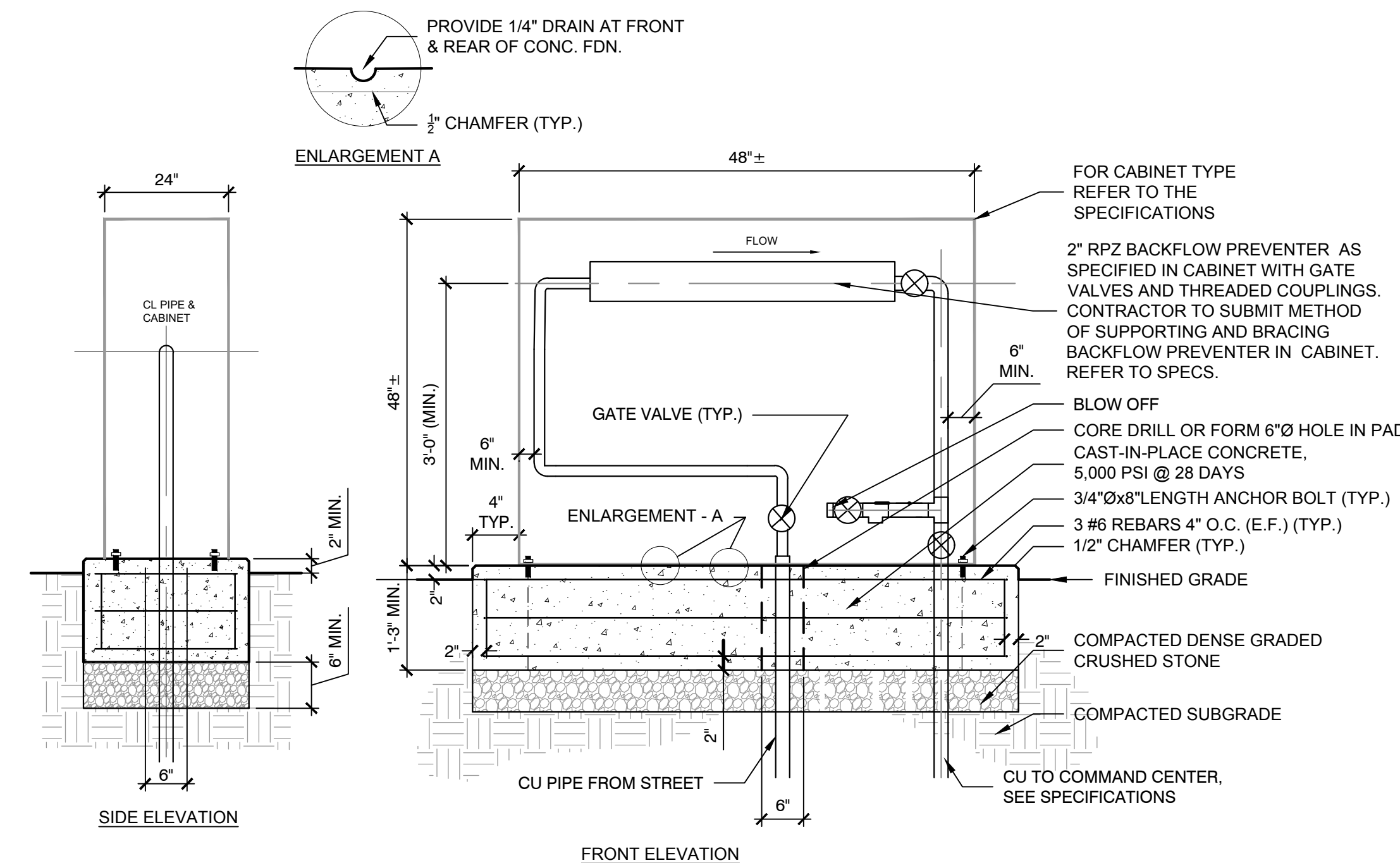

NOTES:
1. INSTALL A BRASS BLOWOFF FITTING AND VALVE ON THE OUTFLOW SIDE OF THE BACKFLOW PREVENTION DEVICE TO WINTERIZE THE SYSTEM AS REQUIRED.
2. THE BACKFLOW PREVENTER & METER SHALL BE INSTALLED WITH UNIONS, HANGERS, SUPPORTS AND ALL OTHER APPROPRIATE FITTINGS, IN ORDER TO EASILY REMOVE THE DEVICE FOR SERVICE AND TO MEET ALL APPLICABLE PLUMBING CODES.
3. BACKFLOW PREVENTER SHALL BE INSTALLED A MINIMUM 6" FROM THE WALLS OF THE METER CABINET.
4. CONFIRM LAYOUT AND ALIGNMENT REQUIREMENTS FOR ALL PIPING, FITTINGS, VALVES, METER, AND BACKFLOW PREVENTER WITH CITY OF BOSTON PLUMBING INSPECTOR PRIOR TO INSTALLATION.
5. SEE SPECIFICATIONS FOR EQUIPMENT INFORMATION.
6. PIPING WITHIN METER CABINET TO BE COPPER TUBING (TYPE L).

5 BACKFLOW PREVENTER CABINET
SCALE: N.T.S.

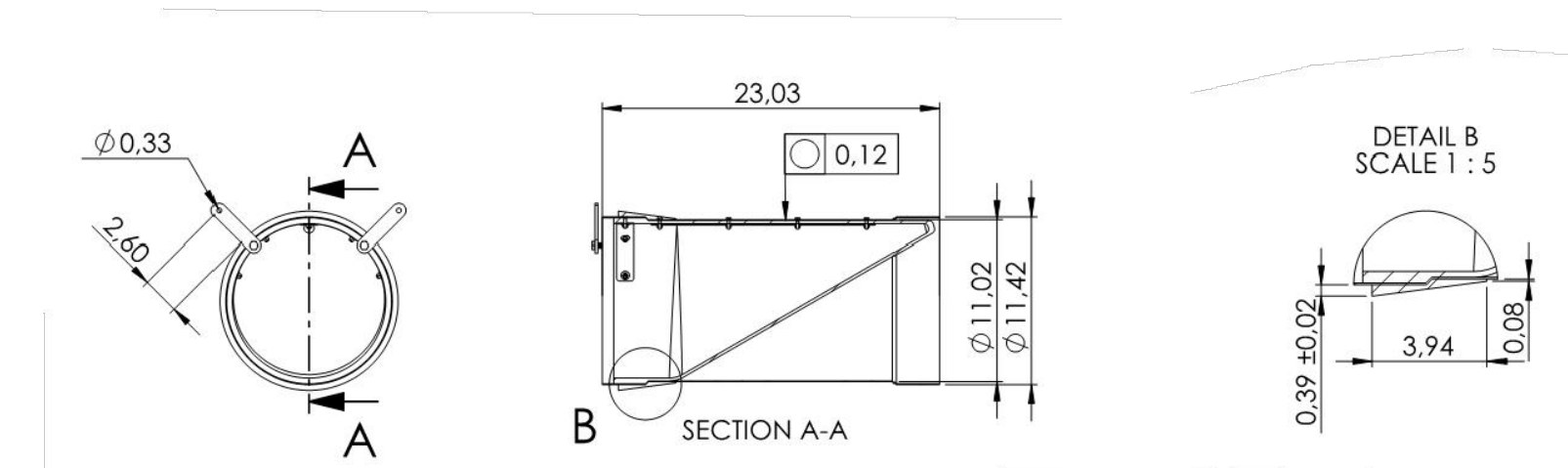

8 IN-LINE CHECK VALVE
SCALE: N.T.S.

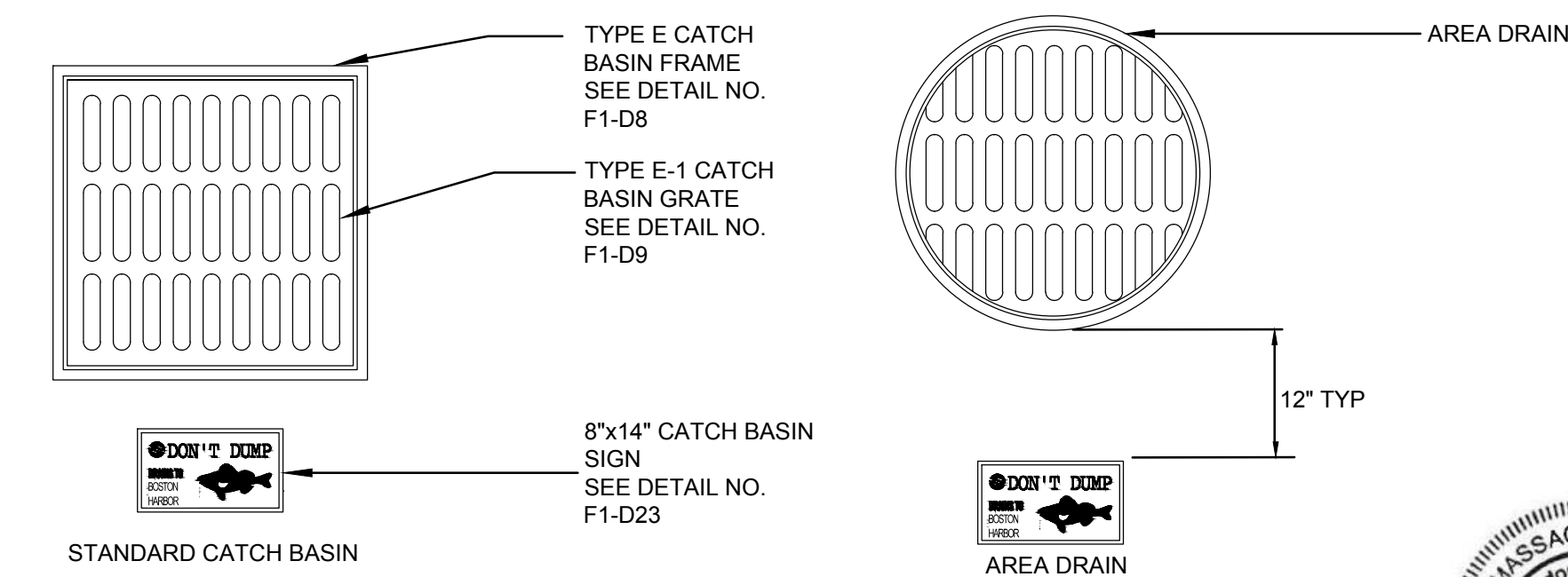

9 CATCH BASIN - BWSC STANDARD
SCALE: N.T.S.

6 BIORETENTION BASIN
SCALE: N.T.S.

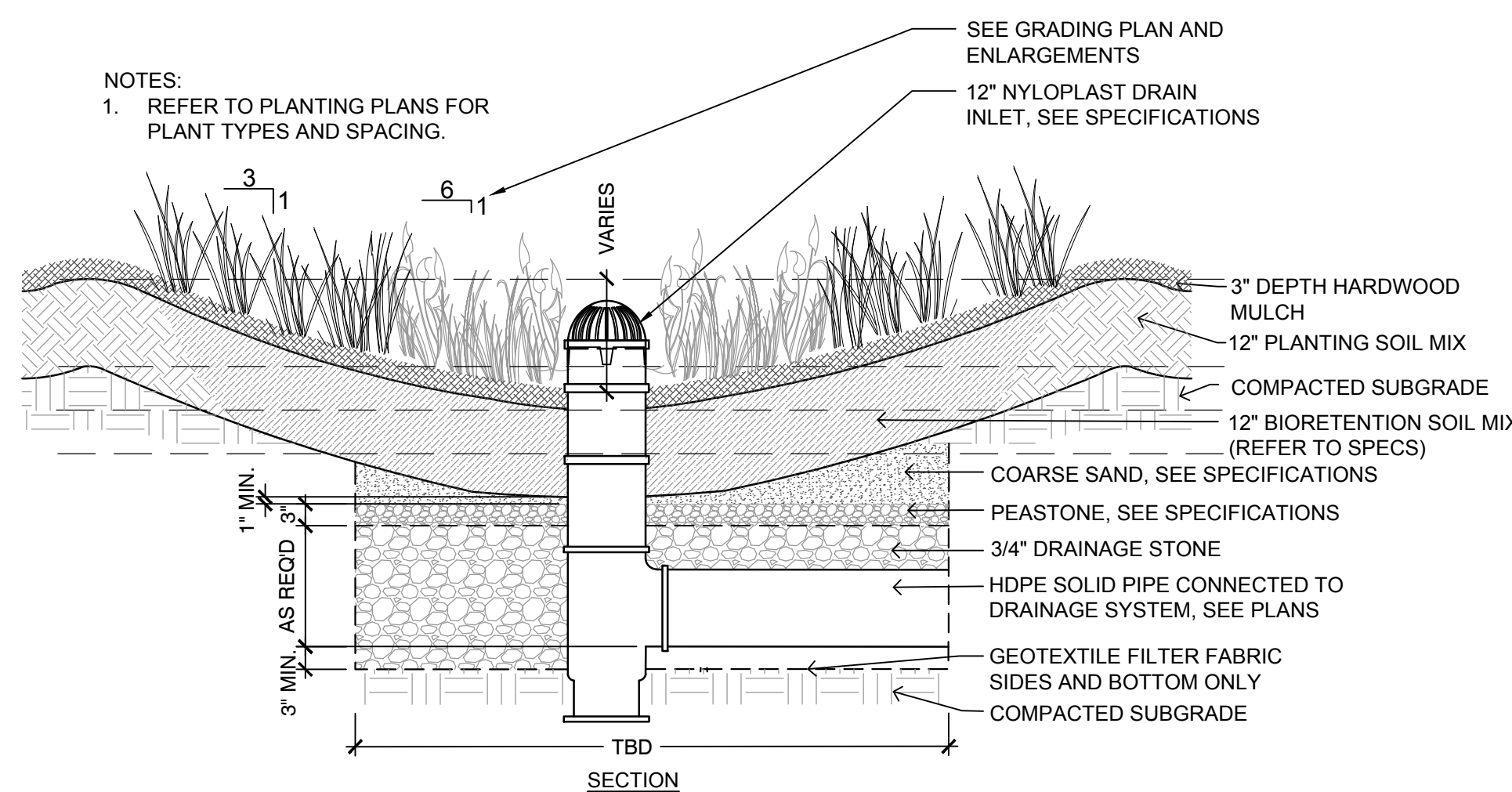

6 BIORETENTION BASIN
SCALE: N.T.S.



Prepared By:

Weston & Sampson

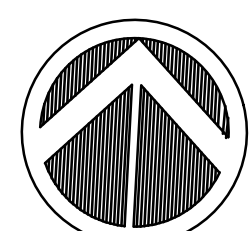

NORTH

Consultant Project No. 2160850

No.	Date	Revision

Approved By: _____ Date: _____

Project Name.:

IMPROVEMENTS TO McCONNELL PARK

BWSC SUBMISSION

Date	FEBRUARY 2021
Scale	
Drawn	ENB, LSR
Checked	CFR

Sheet Name.:

CONSTRUCTION DETAILS

SHEET:

L7.02



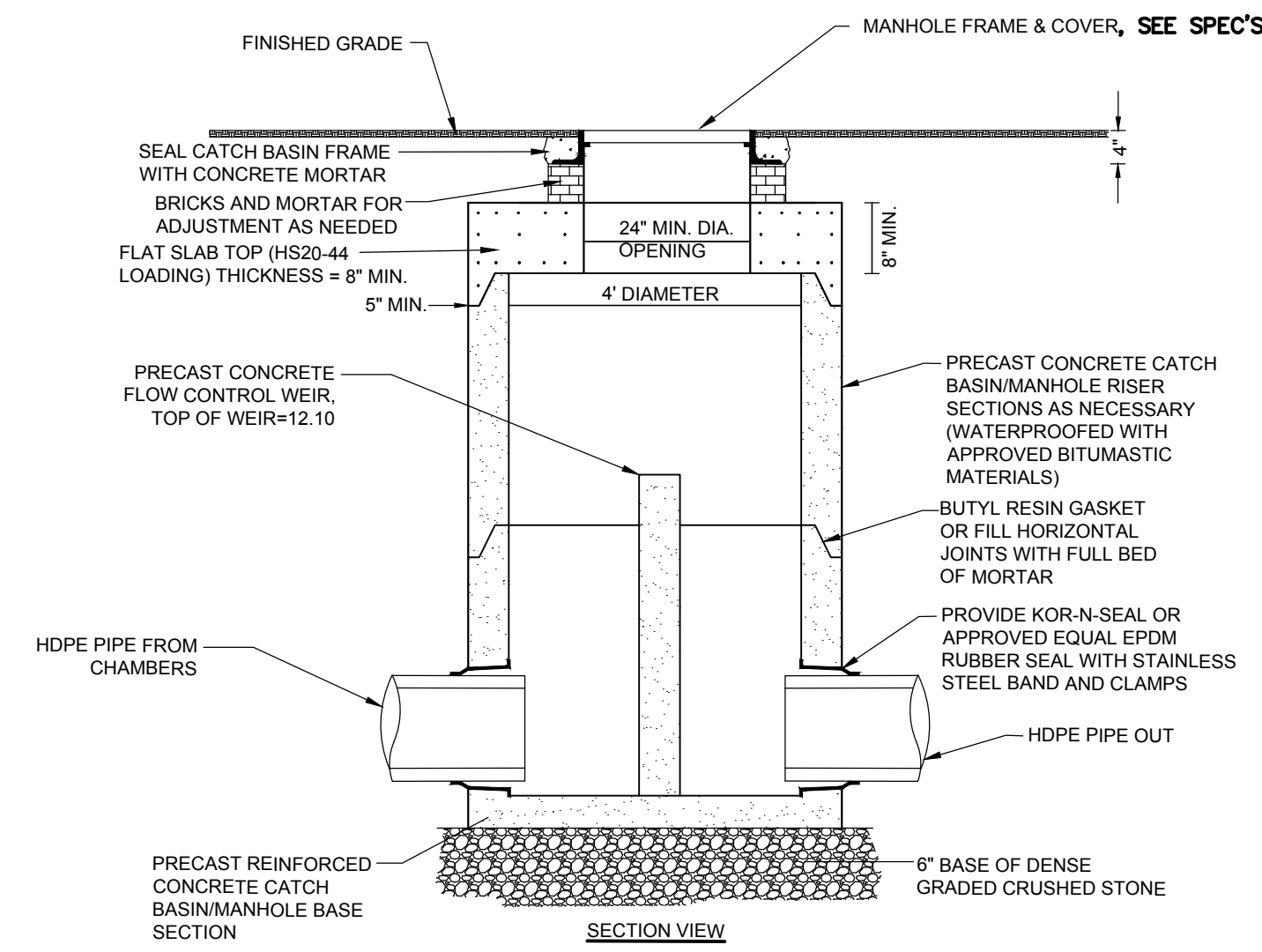

OUTLET CONTROL STRUCTURE DETAIL
NTS

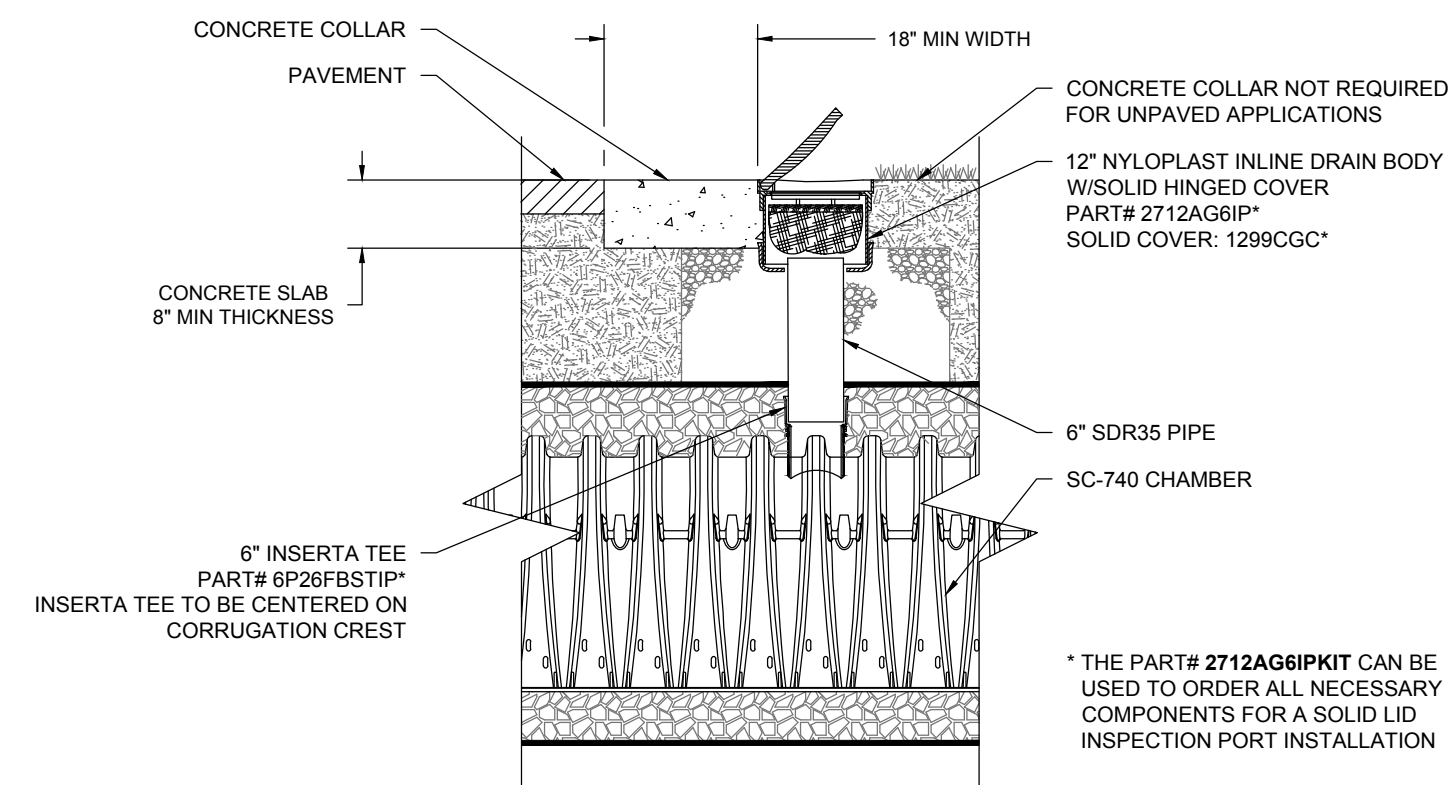

SC-740 6" INSPECTION PORT DETAIL
NTS

PLACE MIN OF 17.5' OF ADS GEOSYNTHETICS 315WTK WOVEN GEOTEXTILE OVER STONE BEDDING AND UNDERNEATH CHAMBER FEET FOR SCOUR PROTECTION AT ALL CHAMBER INLET ROWS

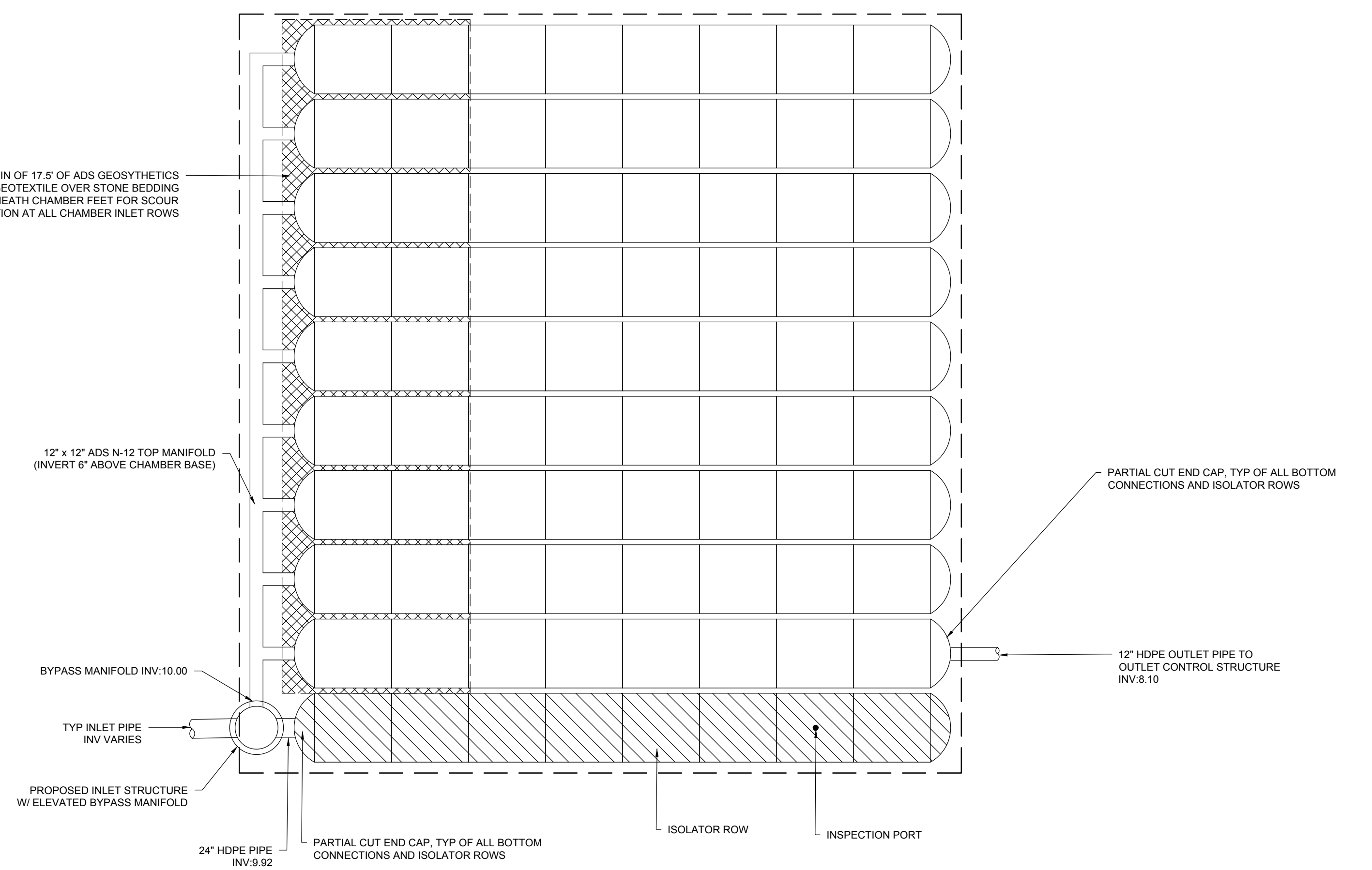

SC-740 PLAN VIEW DETAIL

ACCEPTABLE FILL MATERIALS: STORMTECH SC-740 CHAMBER SYSTEMS

MATERIAL LOCATION	DESCRIPTION	AASHTO MATERIAL CLASSIFICATIONS	COMPACTION / DENSITY REQUIREMENT
D	FINAL FILL: FILL MATERIAL FOR LAYER 'D' STARTS FROM THE TOP OF THE 'C' LAYER TO THE BOTTOM OF FLEXIBLE PAVEMENT OR UNPAVED FINISHED GRADE ABOVE. NOTE THAT PAVEMENT SUBBASE MAY BE PART OF THE 'D' LAYER.	N/A	PREPARE PER SITE DESIGN ENGINEER'S PLANS. PAVED INSTALLATIONS MAY HAVE STRINGENT MATERIAL AND PREPARATION REQUIREMENTS.
C	INITIAL FILL: FILL MATERIAL FOR LAYER 'C' STARTS FROM THE TOP OF THE EMBEDMENT STONE ('B' LAYER) TO 18" ABOVE THE TOP OF THE CHAMBER. NOTE THAT PAVEMENT SUBBASE MAY BE A PART OF THE 'C' LAYER.	AASHTO M145 ¹ A-1, A-2-4, A-3 OR AASHTO M43 ¹ 3, 357, 4, 467, 5, 56, 57, 6, 67, 68, 7, 78, 8, 89, 9, 10	BEGIN COMPACTIONS AFTER 12" OF MATERIAL OVER THE CHAMBERS IS REACHED. COMPACT ADDITIONAL LAYERS IN 6" MAX LIFTS TO A MIN. 95% PROCTOR DENSITY FOR WELL GRADED MATERIAL AND 95% RELATIVE DENSITY FOR PROCESSED AGGREGATE MATERIALS. ROLLER GROSS VEHICLE WEIGHT NOT TO EXCEED 12,000 lbs. DYNAMIC FORCE NOT TO EXCEED 20,000 lbs.
B	EMBEDMENT STONE: FILL SURROUNDING THE CHAMBERS FROM THE FOUNDATION STONE ('A' LAYER) TO THE 'C' LAYER ABOVE.	AASHTO M43 ¹ 3, 357, 4, 467, 5, 56, 57	NO COMPACTION REQUIRED.
A	FOUNDATION STONE: FILL BELOW CHAMBERS FROM THE SUBGRADE UP TO THE FOOT (BOTTOM) OF THE CHAMBER.	AASHTO M43 ¹ 3, 357, 4, 467, 5, 56, 57	PLATE COMPACT OR ROLL TO ACHIEVE A FLAT SURFACE. ^{2,3}

PLEASE NOTE:
 1. THE LISTED AASHTO DESIGNATIONS ARE FOR GRADATIONS ONLY. THE STONE MUST ALSO BE CLEAN, CRUSHED, ANGULAR. FOR EXAMPLE, A SPECIFICATION FOR #4 STONE WOULD STATE: "CLEAN, CRUSHED, ANGULAR NO. 4 (AASHTO M43) STONE".
 2. STORMTECH COMPACTION REQUIREMENTS ARE MET FOR 'A' LOCATION MATERIALS WHEN PLACED AND COMPACTED IN 6" (MAX) LIFTS USING TWO FULL COVERAGES WITH A VIBRATORY COMPACTOR.
 3. WHERE INFILTRATION SURFACES MAY BE COMPROMISED BY COMPACTION, FOR STANDARD DESIGN LOAD CONDITIONS, A FLAT SURFACE MAY BE ACHIEVED BY RAKING OR DRAGGING WITHOUT COMPACTION EQUIPMENT. FOR SPECIAL LOAD DESIGNS, CONTACT STORMTECH FOR COMPACTION REQUIREMENTS.
 4. ONCE LAYER 'C' IS PLACED, ANY SOIL/MATERIAL CAN BE PLACED IN LAYER 'D' UP TO THE FINISHED GRADE. MOST PAVEMENT SUBBASE SOILS CAN BE USED TO REPLACE THE MATERIAL REQUIREMENTS OF LAYER 'C' OR 'D' AT THE SITE DESIGN ENGINEER'S DISCRETION.

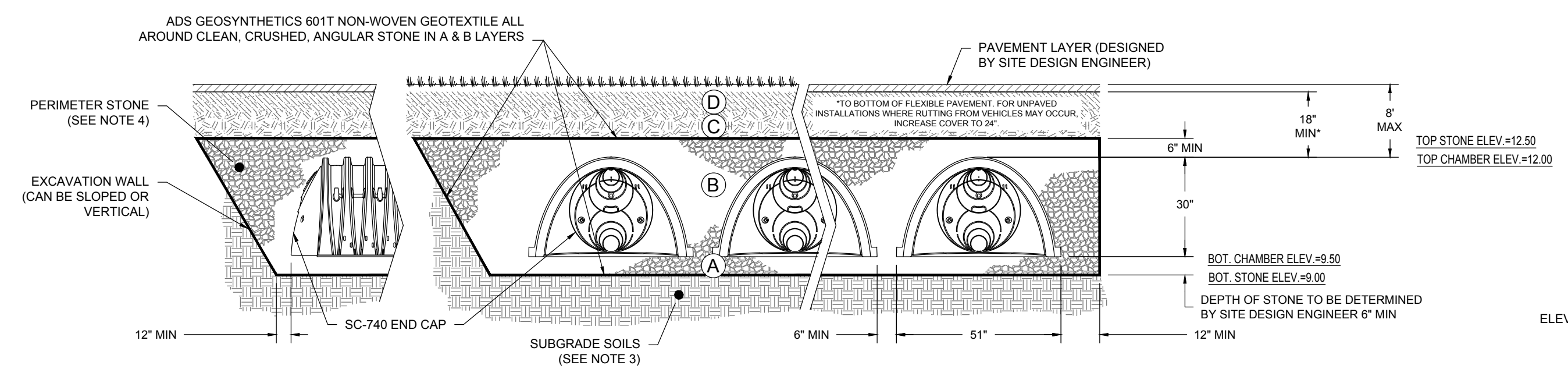

NOTES:

- CHAMBERS SHALL MEET THE REQUIREMENTS OF ASTM F2418-16a, "STANDARD SPECIFICATION FOR POLYPROPYLENE (PP) CORRUGATED WALL STORMWATER COLLECTION CHAMBERS".
- SC-740 CHAMBERS SHALL BE DESIGNED IN ACCORDANCE WITH ASTM F2787 "STANDARD PRACTICE FOR STRUCTURAL DESIGN OF THERMOPLASTIC CORRUGATED WALL STORMWATER COLLECTION CHAMBERS".
- THE SITE DESIGN ENGINEER IS RESPONSIBLE FOR ASSESSING THE BEARING RESISTANCE (ALLOWABLE BEARING CAPACITY) OF THE SUBGRADE SOILS AND THE DEPTH OF FOUNDATION STONE WITH CONSIDERATION FOR THE RANGE OF EXPECTED SOIL MOISTURE CONDITIONS.
- PERIMETER STONE MUST BE EXTENDED HORIZONTALLY TO THE EXCAVATION WALL FOR BOTH VERTICAL AND SLOPED EXCAVATION WALLS.
- REQUIREMENTS FOR HANDLING AND INSTALLATION:
 - TO MAINTAIN THE WIDTH OF CHAMBERS DURING SHIPPING AND HANDLING. CHAMBERS SHALL HAVE INTEGRAL, INTERLOCKING STACKING LUGS.
 - TO ENSURE A SECURE JOINT DURING INSTALLATION AND BACKFILL. THE HEIGHT OF THE CHAMBER JOINT SHALL NOT BE LESS THAN 2".
 - TO ENSURE THE INTEGRITY OF THE ARCH SHAPE DURING INSTALLATION. a) THE ARCH STIFFNESS CONSTANT AS DEFINED IN SECTION 6.2.8 OF ASTM F2418 SHALL BE GREATER THAN OR EQUAL TO 550 LBS/IN (IN AND b) TO RESIST CHAMBER DEFORMATION DURING INSTALLATION AT ELEVATED TEMPERATURES (ABOVE 73° F / 23° C), CHAMBERS SHALL BE PRODUCED FROM REFLECTIVE GOLD OR YELLOW COLORS.

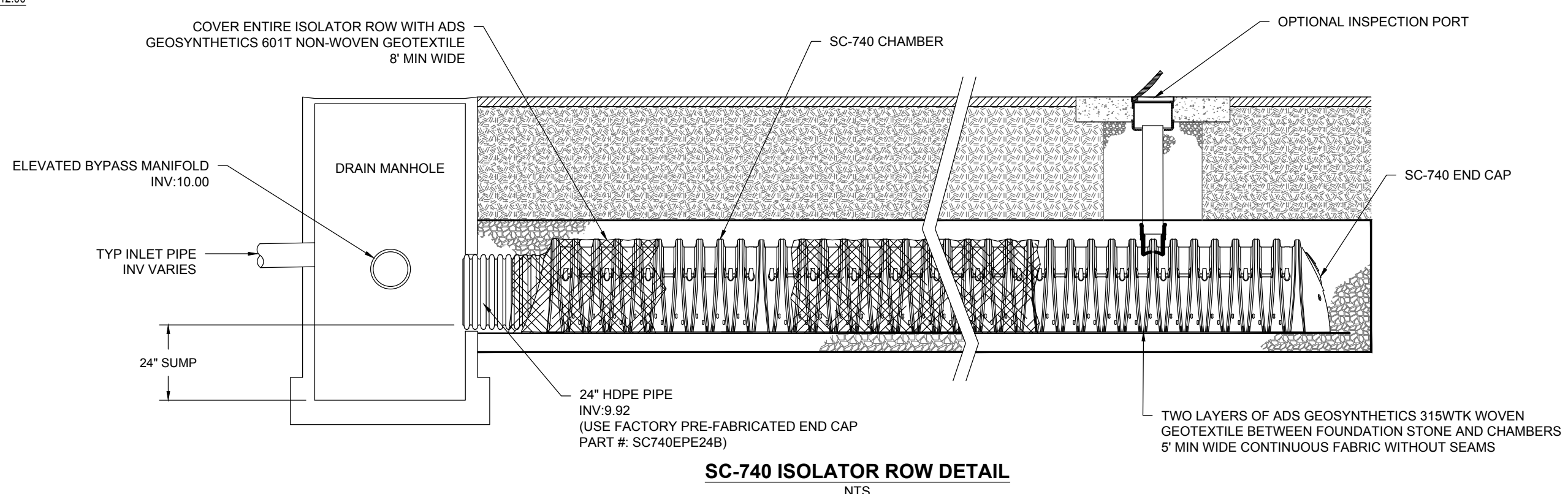

SC-740 ISOLATOR ROW DETAIL
NTS

INSPECTION & MAINTENANCE

- STEP 1) INSPECT ISOLATOR ROW FOR SEDIMENT
- INSPECTION PORTS (IF PRESENT)
 - REMOVE/OPEN LID ON NYLOPLAST INLINE DRAIN
 - REMOVE AND CLEAN FLEXSTORM FILTER IF INSTALLED
 - USING A FLASHLIGHT AND STADIA ROD, MEASURE DEPTH OF SEDIMENT AND RECORD ON MAINTENANCE LOG
 - LOWER A CAMERA INTO ISOLATOR ROW FOR VISUAL INSPECTION OF SEDIMENT LEVELS (OPTIONAL)
 - IF SEDIMENT IS AT, OR ABOVE, 3" PROCEED TO STEP 2. IF NOT, PROCEED TO STEP 3.
 - ALL ISOLATOR ROWS
 - REMOVE COVER FROM STRUCTURE AT UPSTREAM END OF ISOLATOR ROW
 - USING A FLASHLIGHT, INSPECT DOWN THE ISOLATOR ROW THROUGH OUTLET PIPE
 - MIRRORS ON POLES OR CAMERAS MAY BE USED TO AVOID A CONFINED SPACE ENTRY
 - FOLLOW OSHA REGULATIONS FOR CONFINED SPACE ENTRY IF ENTERING MANHOLE
 - IF SEDIMENT IS AT, OR ABOVE, 3" PROCEED TO STEP 2. IF NOT, PROCEED TO STEP 3.
- STEP 2) CLEAN OUT ISOLATOR ROW USING THE JETVAC PROCESS
- A FIXED CULVERT CLEANING NOZZLE WITH REAR FACING SPREAD OF 45° OR MORE IS PREFERRED
 - APPLY MULTIPLE PASSES OF JETVAC UNTIL BACKFLUSH WATER IS CLEAN
 - VACUUM STRUCTURE SUMP AS REQUIRED
- STEP 3) REPLACE ALL COVERS, GRATES, FILTERS, AND LIDS; RECORD OBSERVATIONS AND ACTIONS.
- STEP 4) INSPECT AND CLEAN BASINS AND MANHOLES UPSTREAM OF THE STORMTECH SYSTEM.

NOTES

- INSPECT EVERY 6 MONTHS DURING THE FIRST YEAR OF OPERATION. ADJUST THE INSPECTION INTERVAL BASED ON PREVIOUS OBSERVATIONS OF SEDIMENT ACCUMULATION AND HIGH WATER ELEVATIONS.
- CONDUCT JETTING AND VACTORING ANNUALLY OR WHEN INSPECTION SHOWS THAT MAINTENANCE IS NECESSARY.

1 STORMTECH SC-740 SUBSURFACE CHAMBER SYSTEM
SCALE: N.T.S.



	Prepared By:			No.	Date	Revision	Project Name: IMPROVEMENTS TO McCONNELL PARK	BWSC SUBMISSION Date: FEBRUARY 2021 Scale: Drawn: ENB, LSR Checked: CFR	Sheet Name: CONSTRUCTION DETAILS	SHEET: L7.03
	Consultant Project No. 2160850			Approved By:	Date:					

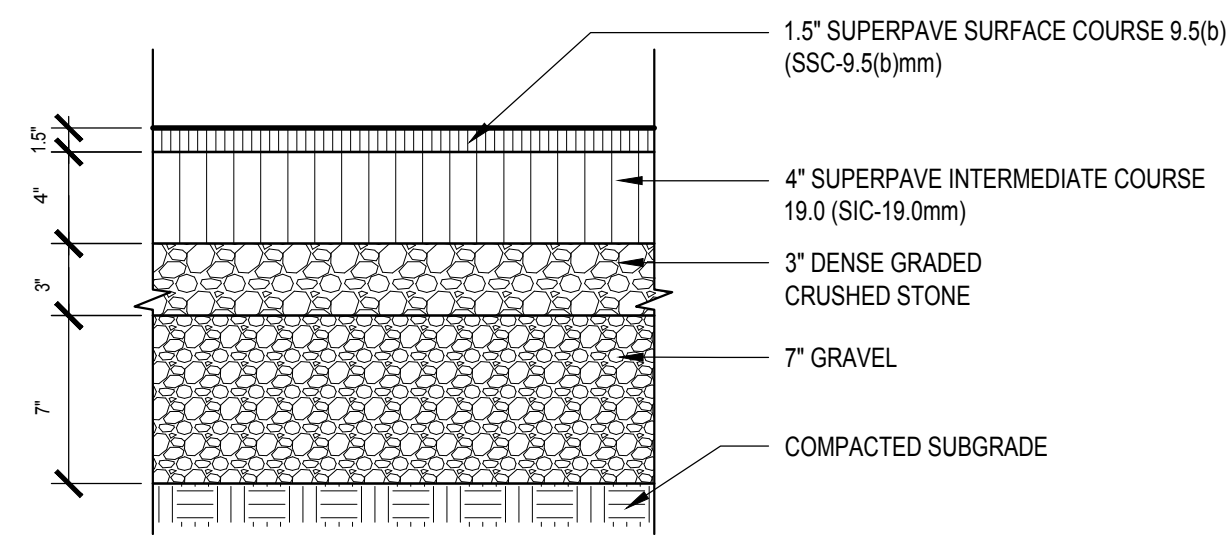

NOTE:
1. CONTRACTOR TO PROVIDE SMOOTH TRANSITION WHERE NEW PAVEMENT ABUTS EXISTING PAVEMENT, TYP.

1 BITUMINOUS CONCRETE PAVEMENT - VEHICULAR
SCALE: N.T.S.

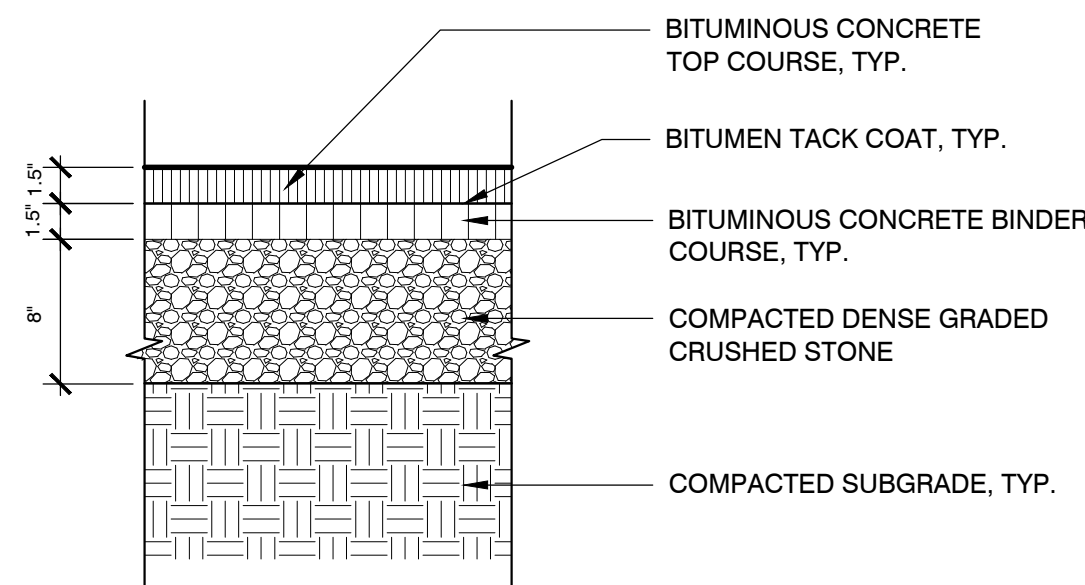

NOTE:
1. CONTRACTOR TO PROVIDE SMOOTH TRANSITION WHERE NEW PAVEMENT ABUTS EXISTING PAVEMENT, TYP.

2 BITUMINOUS CONCRETE PAVEMENT - PEDESTRIAN
SCALE: N.T.S.

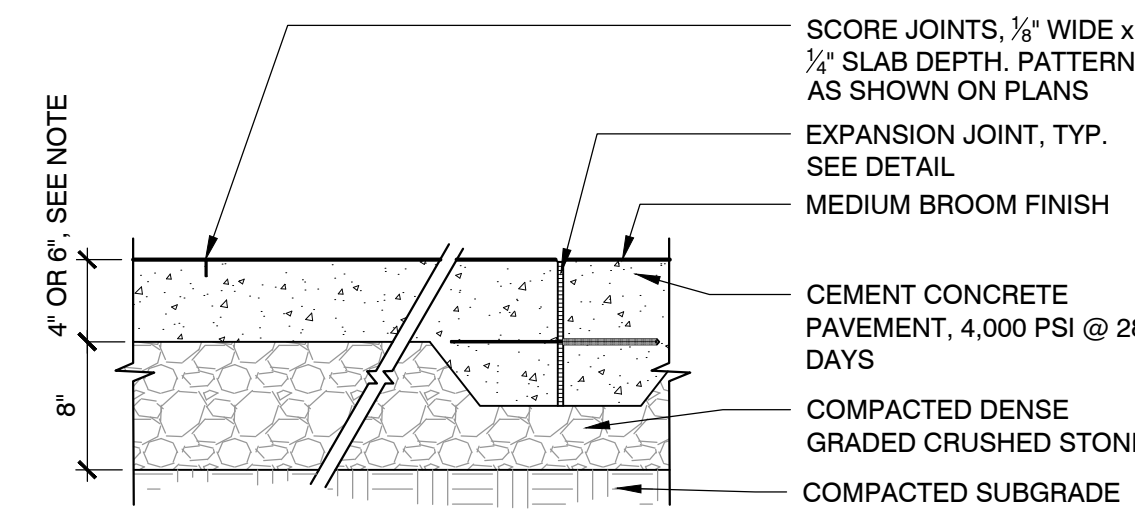

CAST-IN-PLACE CONCRETE PAVEMENT
CAST-IN-PLACE CONCRETE NOTES:

1. PEDESTRIAN CAST-IN-PLACE CONCRETE PAVEMENT TO BE 4" THICK
2. SIDEWALK AT SPRINGDALE STREET, BOTH SIDES, TO BE 6" THICK
3. VEHICULAR CAST-IN-PLACE CONCRETE PAVEMENT TO BE 6" THICK
4. CAST-IN-PLACE CONCRETE AT YACHT CLUB ACCESS DRIVE RAISED TABLE TO BE 8" DEPTH, SEE RAISED TABLE

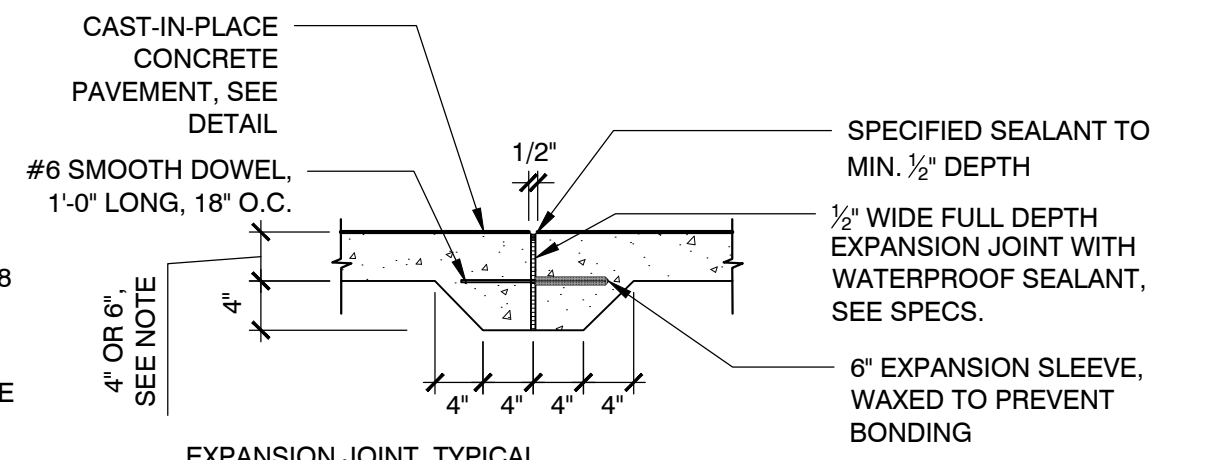

EXPANSION JOINT, TYPICAL
EXPANSION JOINT INSTALLATION NOTES:

1. DOWEL IS TYPICAL AT ALL EXPANSION JOINTS (18" O.C.) WITHIN CONCRETE PAVING AND BETWEEN NEW CONCRETE PAVING AND EXISTING CONCRETE PAVING TO REMAIN.
2. DELETE EXPANSION SLEEVE AND DOWEL WHERE JOINT ABUTS WALL, CURBS, OR OTHER VERTICAL SURFACES, UNLESS OTHERWISE NOTED.
3. EXPANSION JOINTS MAX. 25'-0" O.C. UNLESS SHOWN OTHERWISE.
4. ALL SCORE JOINTS SHALL BE SAW CUT.

3 CAST-IN-PLACE CONCRETE PAVEMENT
SCALE: N.T.S.

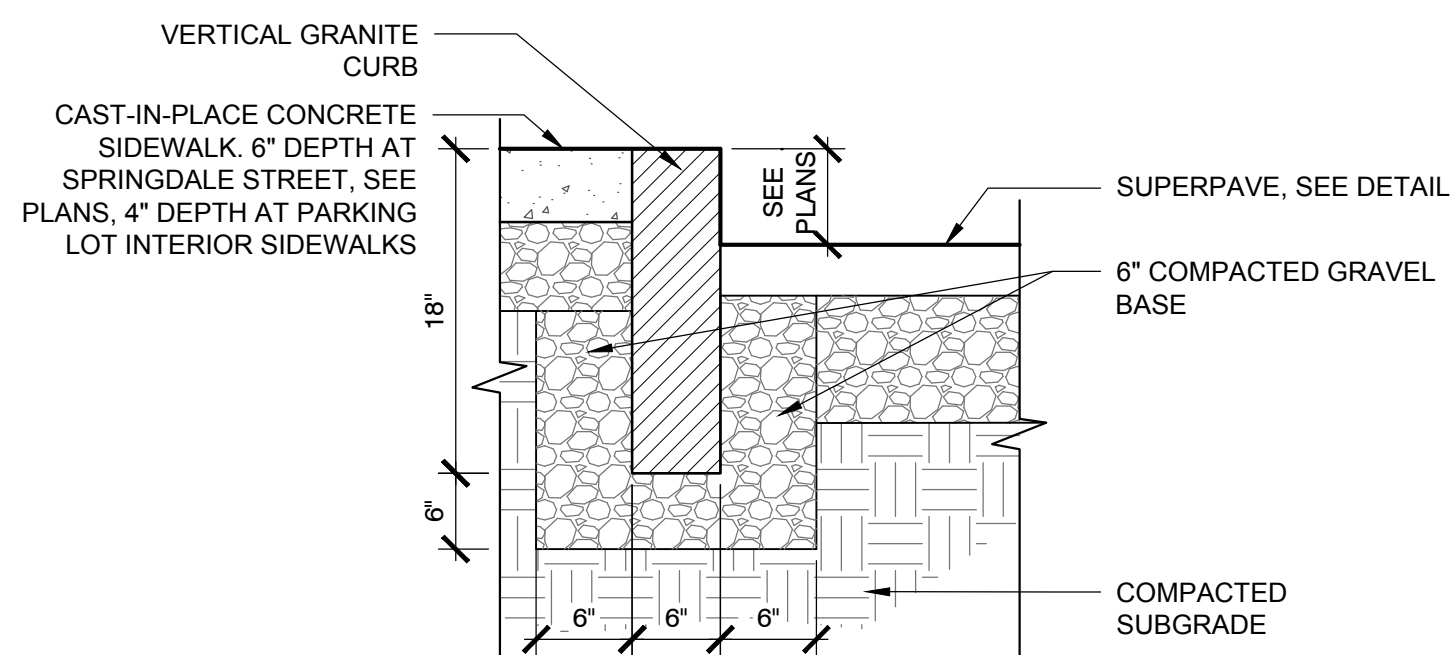

NOTE:
1. *6" REVEAL TYPICAL. REVEAL MAY VARY FROM 3" TO 9" WITH BPWD APPROVAL.

4 VERTICAL GRANITE CURB
SCALE: N.T.S.

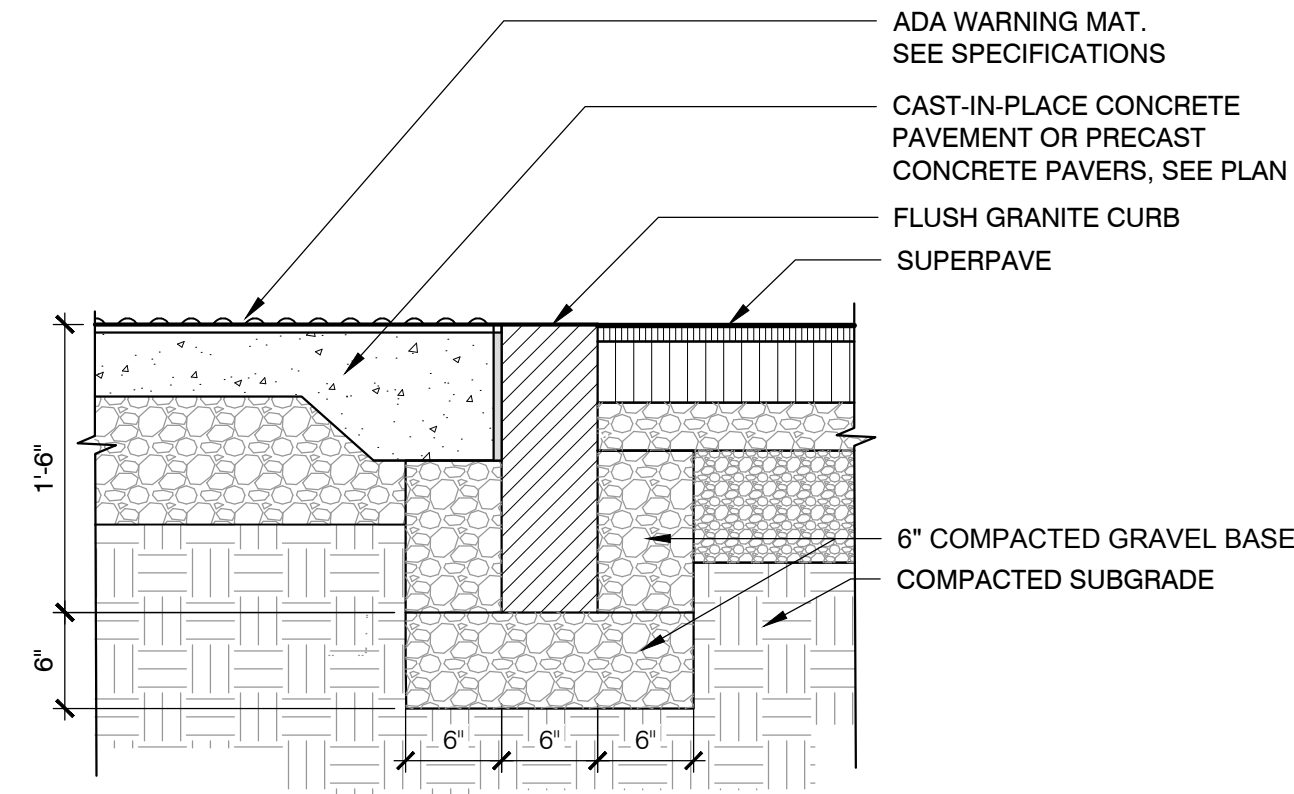

5 FLUSH GRANITE CURB
SCALE: N.T.S.

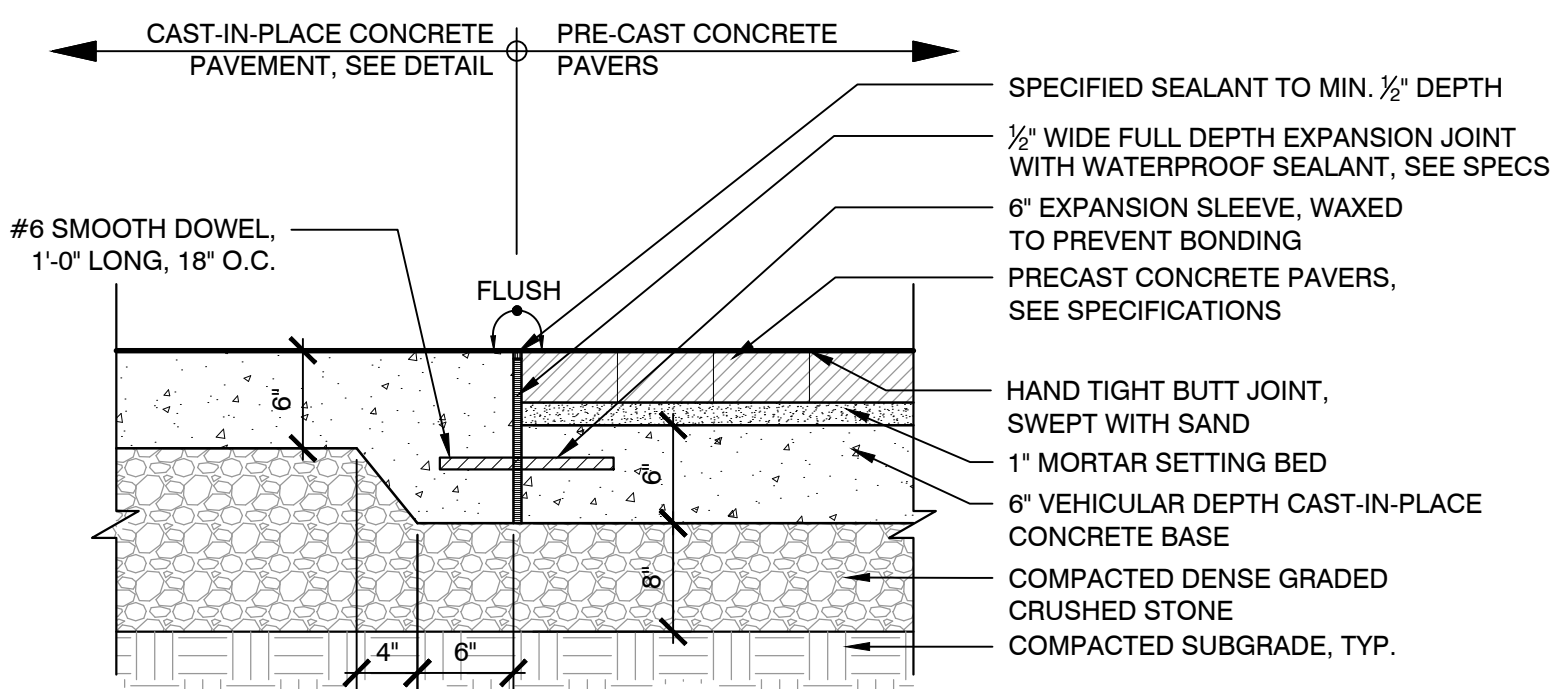

6 PRE-CAST CONCRETE PAVERS
SCALE: N.T.S.

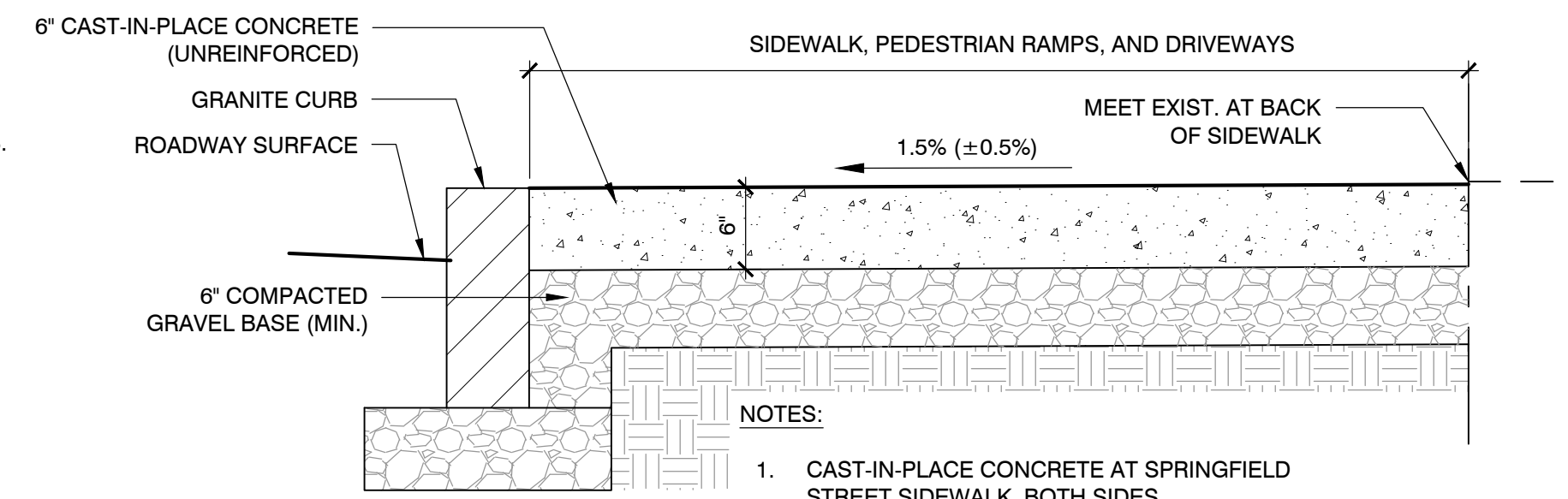

NOTES:
1. CAST-IN-PLACE CONCRETE AT SPRINGFIELD STREET SIDEWALK, BOTH SIDES.
2. EXTENTS OF THIS SIDEWALK DETAIL TO BE AT EXTENTS SHOWN ON PLANS

7 CONCRETE SIDEWALK AT SPRINGDALE STREET
SCALE: N.T.S.

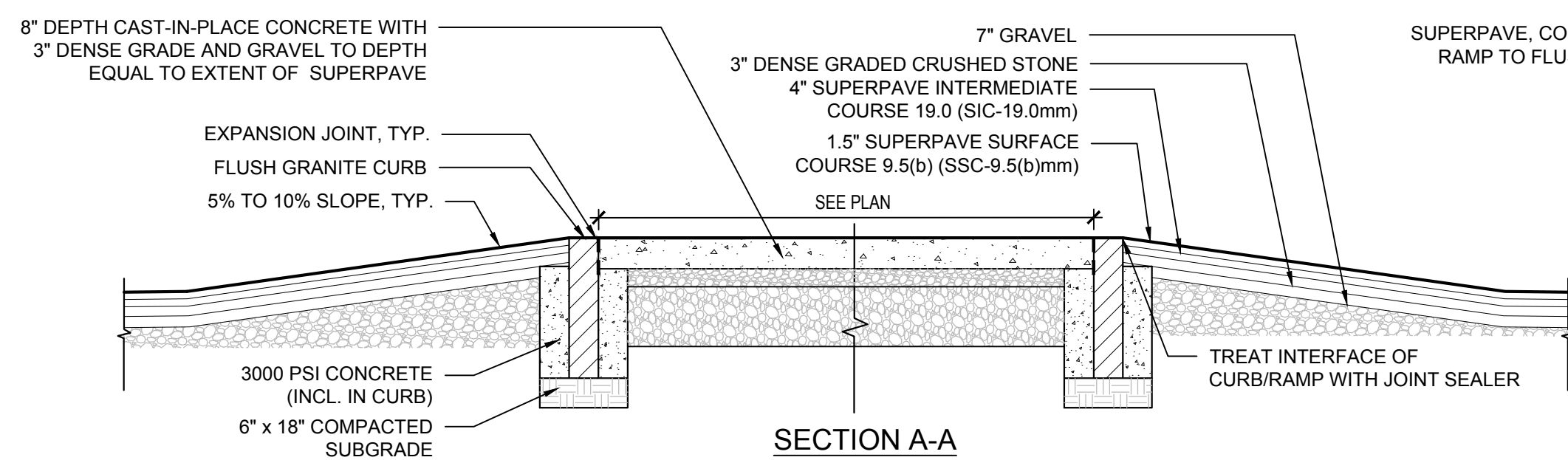

NOTES:
1. CONTRACTION JOINTS TO BE SPACED AT A MAXIMUM OF 10' APART.
2. CONCRETE TO BE 5,000 PSI - 3/4" - 705 LB/CY

8 RAISED TABLE
SCALE: N.T.S.

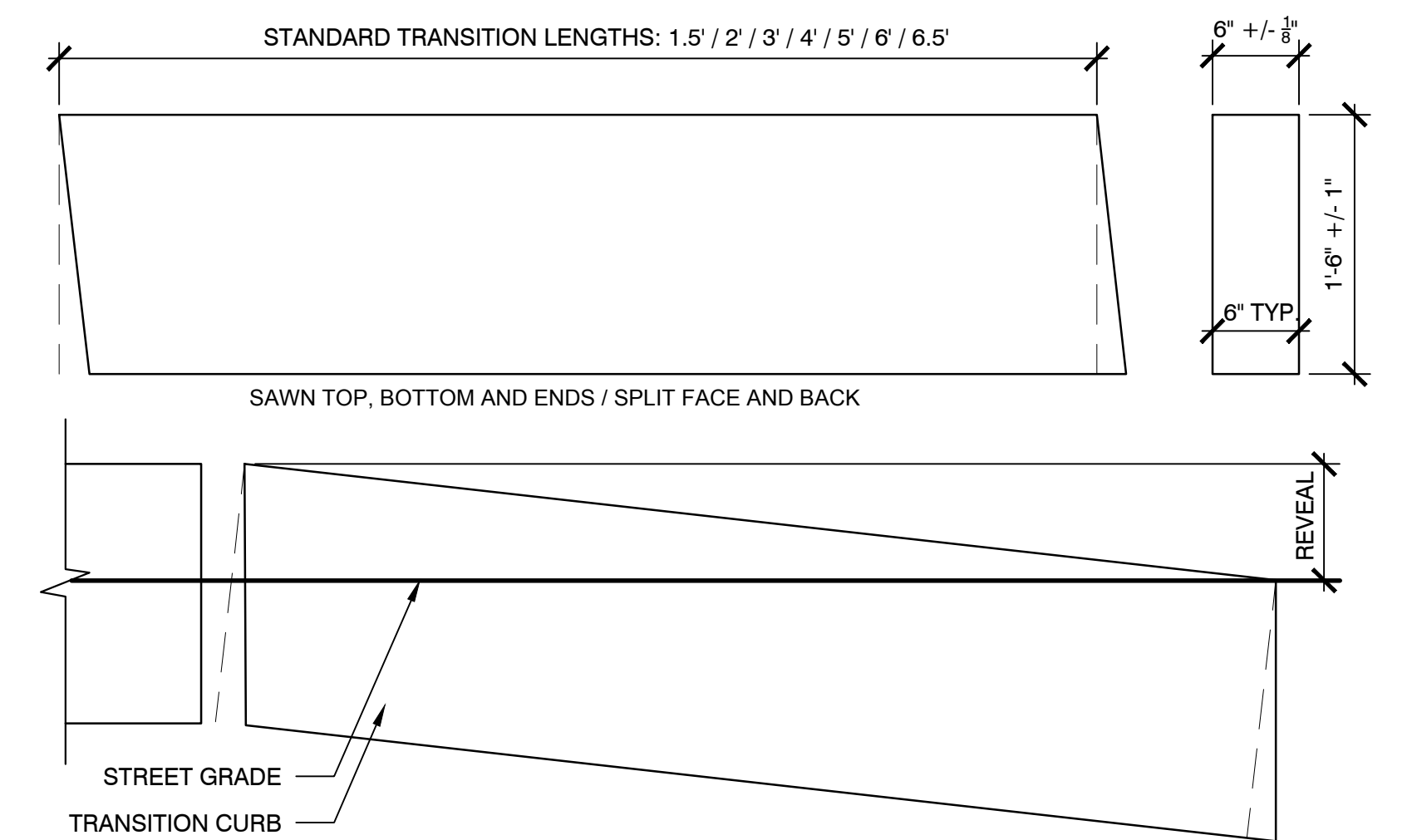
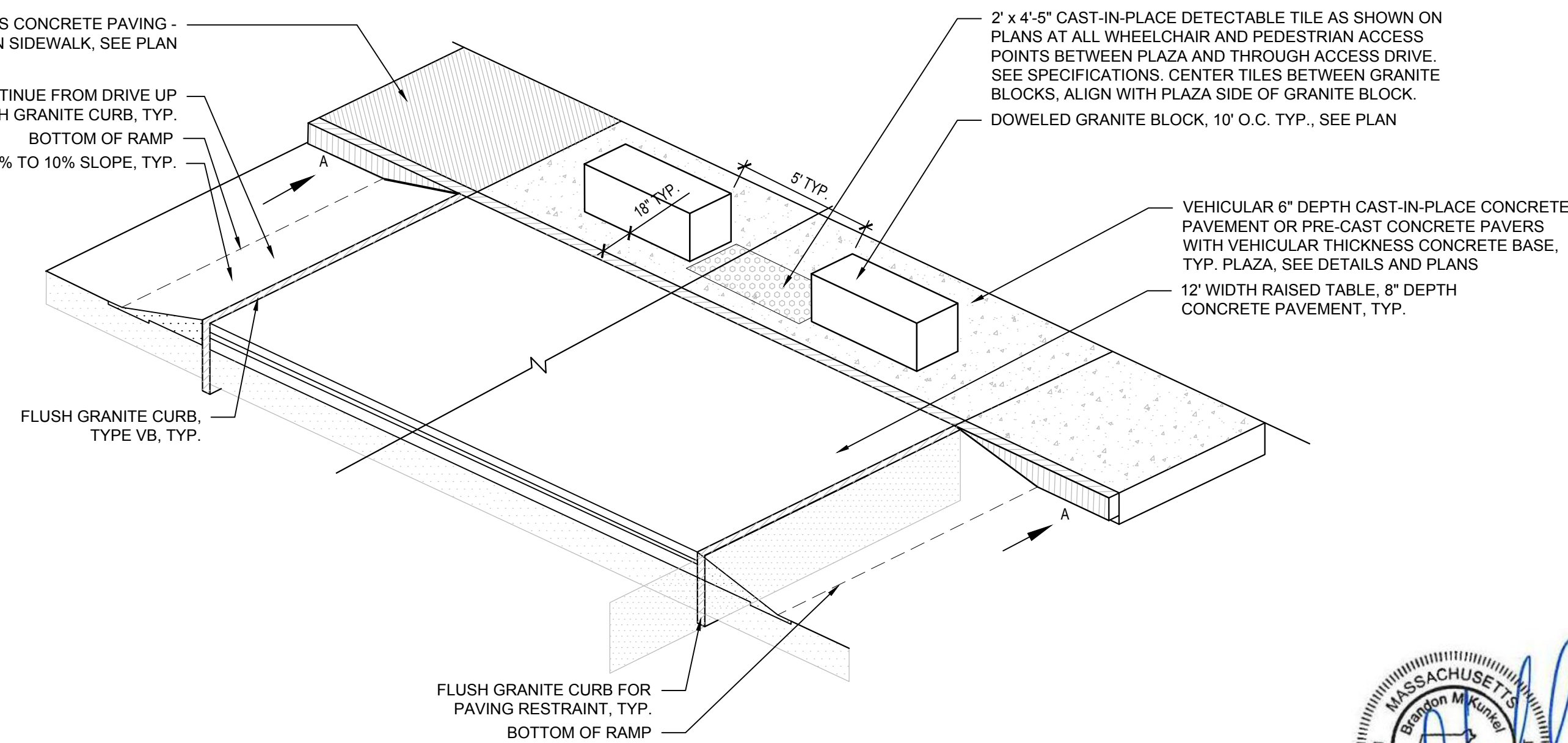

NOTES:
1. ALL TRANSITIONS LONGER THAN 6.9' WILL BE MANUFACTURED IN THE FIELD BY THE SETTER FROM STANDARD CURBING.
2. ALL TRANSITIONS COMPRISED OF A STRAIGHT AND RADIUS SECTION WILL BE MANUFACTURED IN THE FIELD BY THE SETTER FROM STANDARD CURBING.

9 TRANSITION CURB
SCALE: N.T.S.



Prepared By:

Weston & Sampson

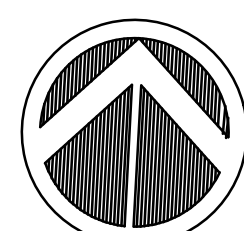

NORTH

No.	Date	Revision

Approved By: _____ Date: _____

Project Name.:

**IMPROVEMENTS TO
McCONNELL PARK**

BWSC SUBMISSION

Date	FEBRUARY 2021
Scale	
Drawn	ENB, LSR
Checked	CFR

Sheet Name.:

CONSTRUCTION
DETAILS

SHEET:

L7.04

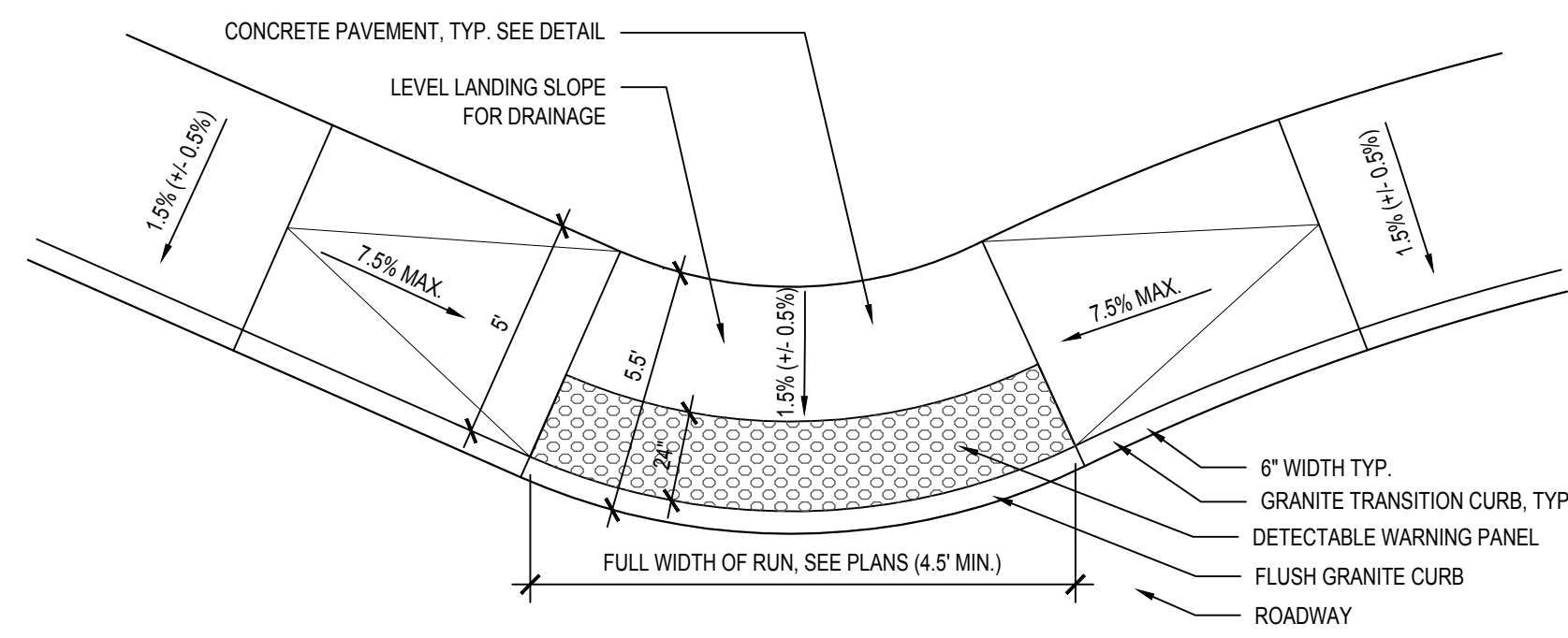

- NOTES:
1. CONTRACTOR SHALL PROVIDE CLEAN AND STRAIGHT SAWCUT LINES AT LIMIT OF REMOVAL OF EXISTING ASPHALT PAVEMENT TO REMAIN. CONTRACTOR SHALL VERIFY LIMITS OF EXISTING ASPHALT PAVEMENT REMOVAL PRIOR TO COMMENCING DEMOLITION.
 2. CONTRACTOR SHALL REMOVE AND REPLACE ASPHALT PAVEMENT, GRAVEL BORROW, AND SUBGRADE NECESSARY TO CONSTRUCT A CLEAN, SMOOTH TRANSITION AT ADA CURB CUT.

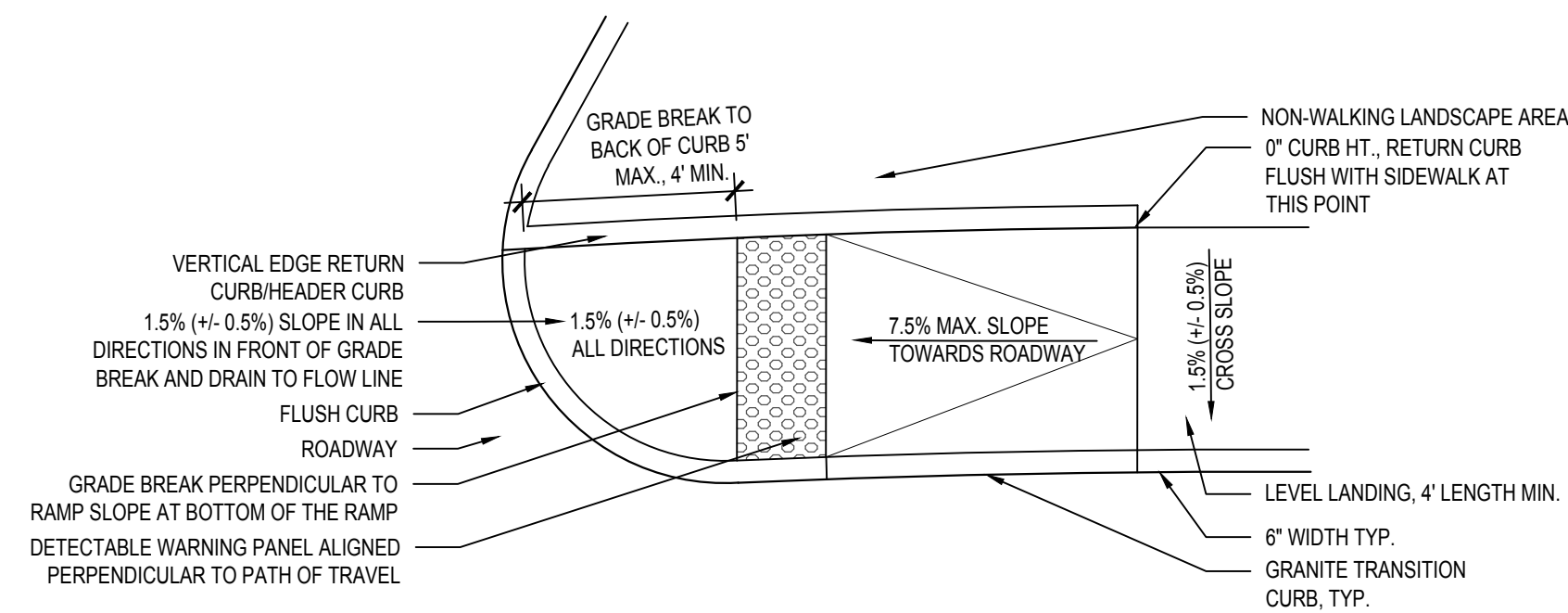

- NOTES:
1. CONTRACTOR SHALL PROVIDE CLEAN AND STRAIGHT SAWCUT LINES AT LIMIT OF REMOVAL OF EXISTING ASPHALT PAVEMENT TO REMAIN. CONTRACTOR SHALL VERIFY LIMITS OF EXISTING ASPHALT PAVEMENT REMOVAL PRIOR TO COMMENCING DEMOLITION.
 2. CONTRACTOR SHALL REMOVE AND REPLACE ASPHALT PAVEMENT, GRAVEL BORROW, AND SUBGRADE NECESSARY TO CONSTRUCT A CLEAN, SMOOTH TRANSITION AT ADA CURB CUT.

1 APEX ACCESSIBLE CURB CUT

SCALE: N.T.S.

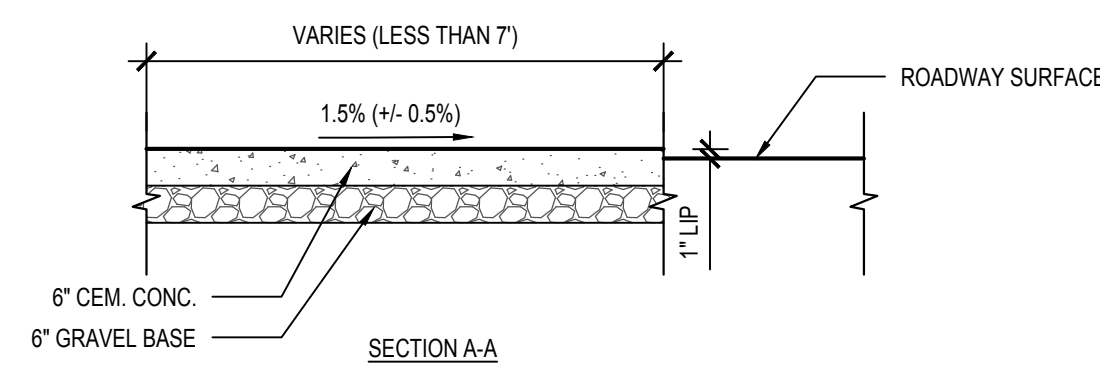
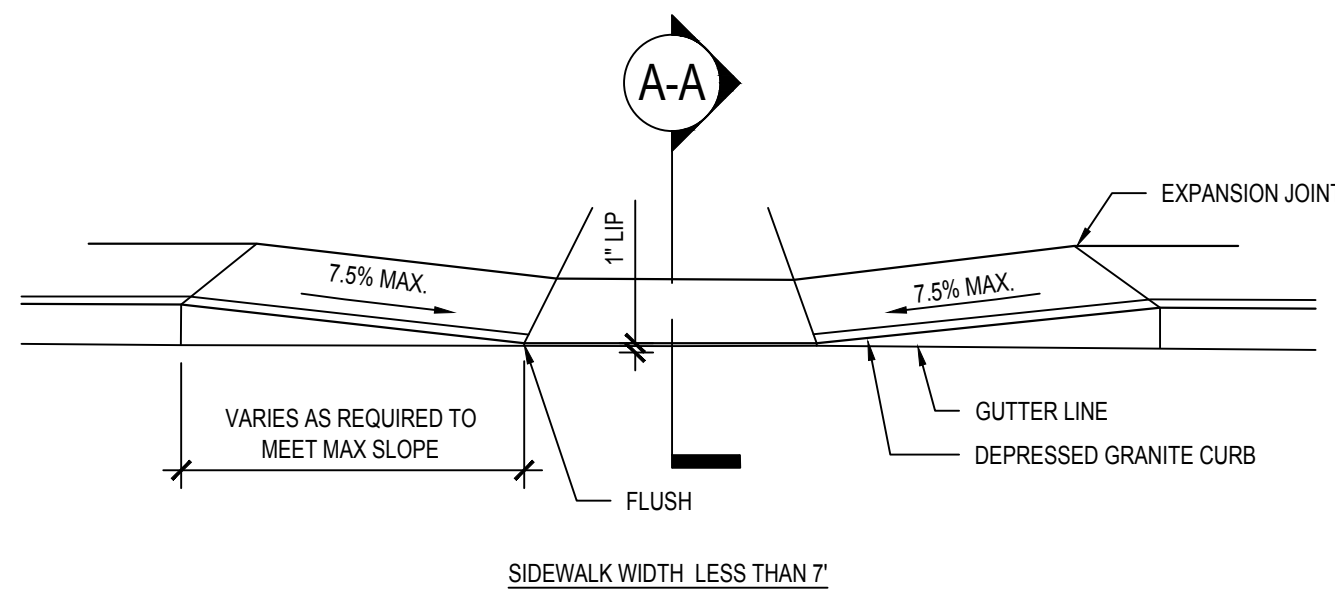

3 SIDEWALK AT DRIVEWAY

SCALE: N.T.S.

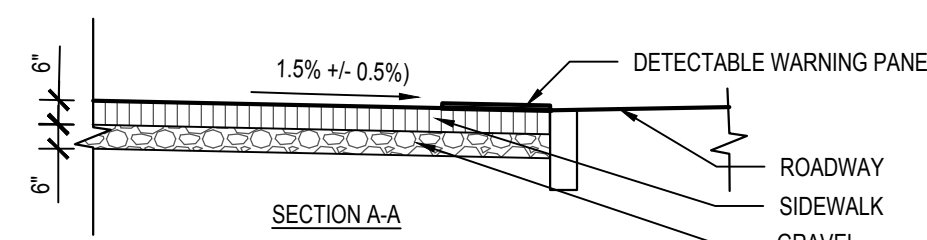
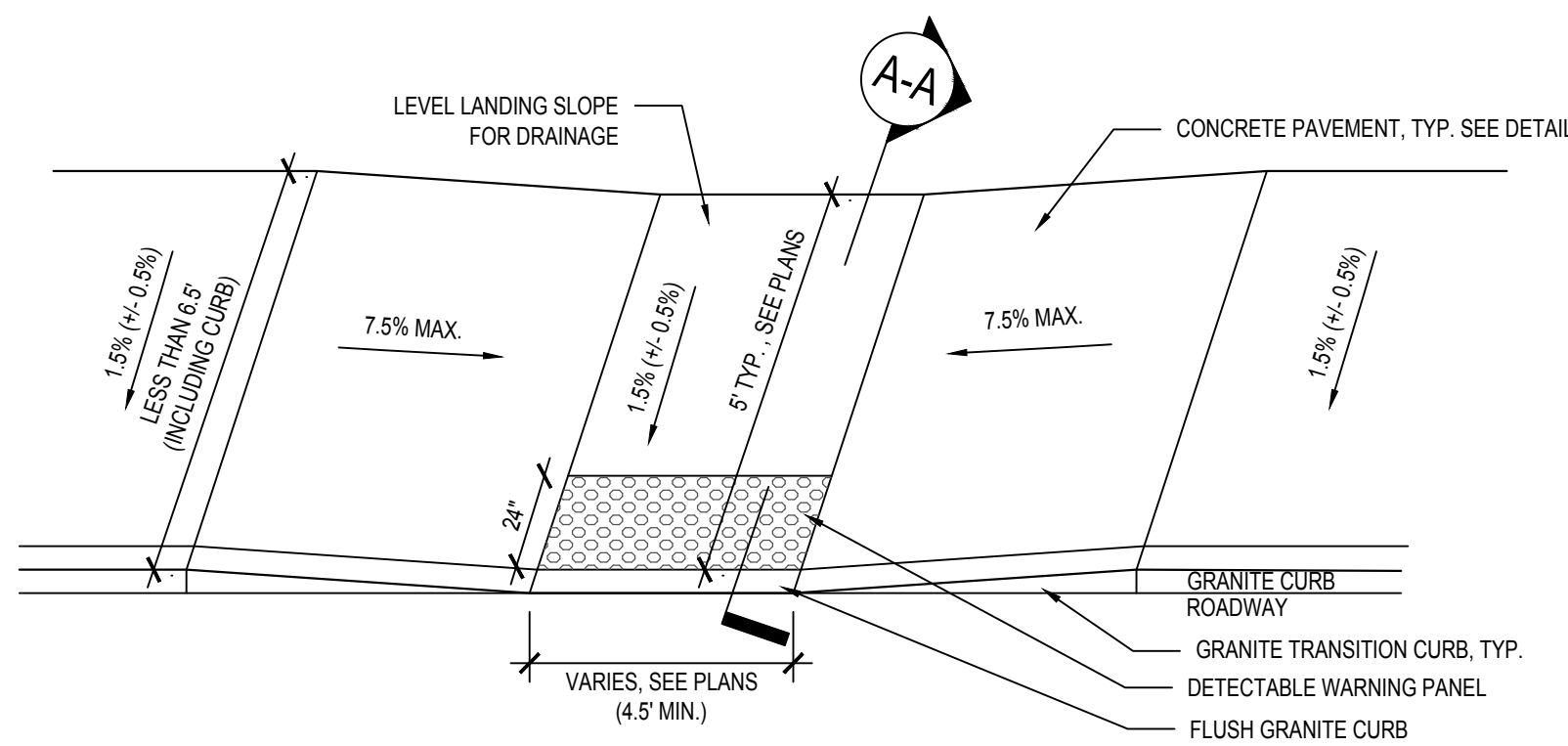

- NOTES:
1. CONTRACTOR SHALL PROVIDE CLEAN AND STRAIGHT SAWCUT LINES AT LIMIT OF REMOVAL OF EXISTING ASPHALT PAVEMENT TO REMAIN. CONTRACTOR SHALL VERIFY LIMITS OF EXISTING ASPHALT PAVEMENT REMOVAL PRIOR TO COMMENCING DEMOLITION.
 2. CONTRACTOR SHALL REMOVE AND REPLACE ASPHALT PAVEMENT, GRAVEL BORROW, AND SUBGRADE NECESSARY TO CONSTRUCT A CLEAN, SMOOTH TRANSITION AT ADA CURB CUT.

2 APEX ACCESSIBLE CURB CUT WITH RETURN CURB

SCALE: N.T.S.

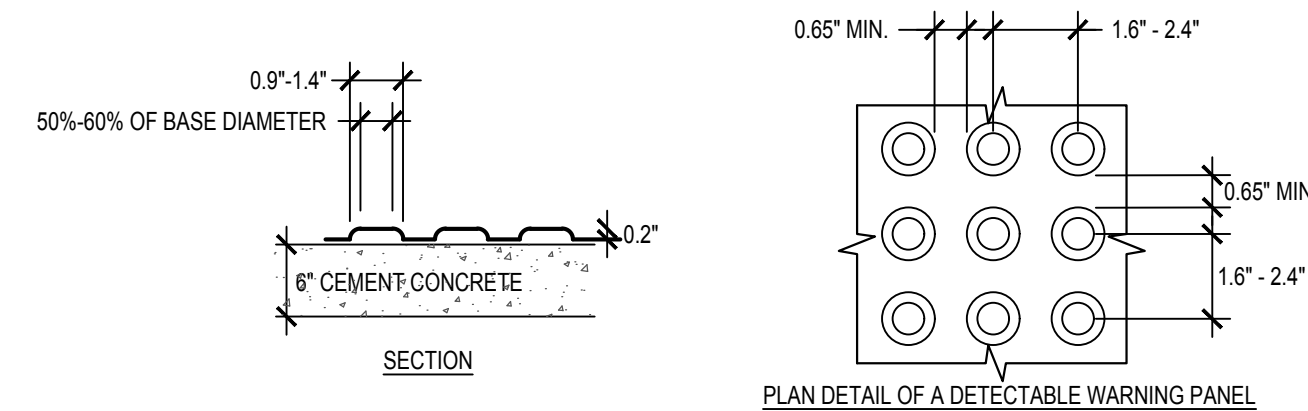

- NOTES:
1. DETECTABLE WARNING PANELS SHALL BE PERMANENTLY APPLIED TO THE CURB RAMP.
 2. DETECTABLE WARNING PANELS SHALL BE PALE YELLOW IN COLOR, CONFORMING TO FEDERAL NO. 23894, UNLESS OTHERWISE SPECIFIED BY PWD.
 3. DETECTABLE WARNING PANELS SHALL BE COMPOSITE.
 4. DETECTABLE WARNING PANELS SHALL BE INSTALLED PER THE MANUFACTURER'S RECOMMENDATIONS.

4 CURB-RAMP- DETECTABLE WARNING PANEL

SCALE: N.T.S.

5 ACCESSIBLE CURB CUT TYPE A - SIDEWALK LESS THAN 6.5'

SCALE: N.T.S.



Prepared By:



Consultant Project No. 2160850

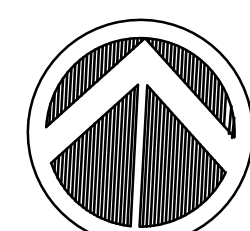

NORTH

No.	Date	Revision

Approved By:

Date:

Project Name.:

**IMPROVEMENTS TO
McCONNELL PARK**

BWSC SUBMISSION

Date FEBRUARY 2021

Scale

Drawn ENB, LSR

Checked CFR

Sheet Name.:

CONSTRUCTION
DETAILS

SHEET:

L7.05

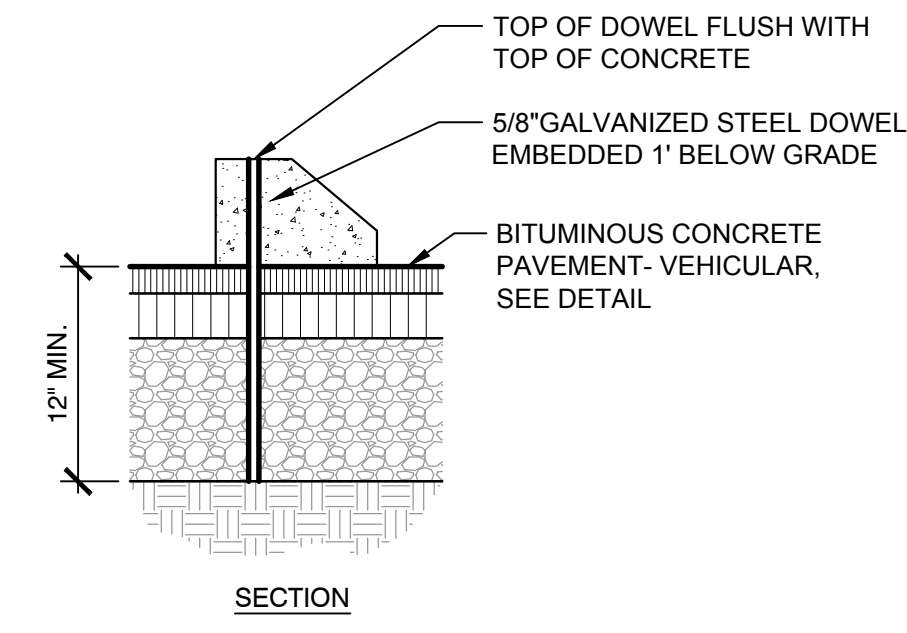
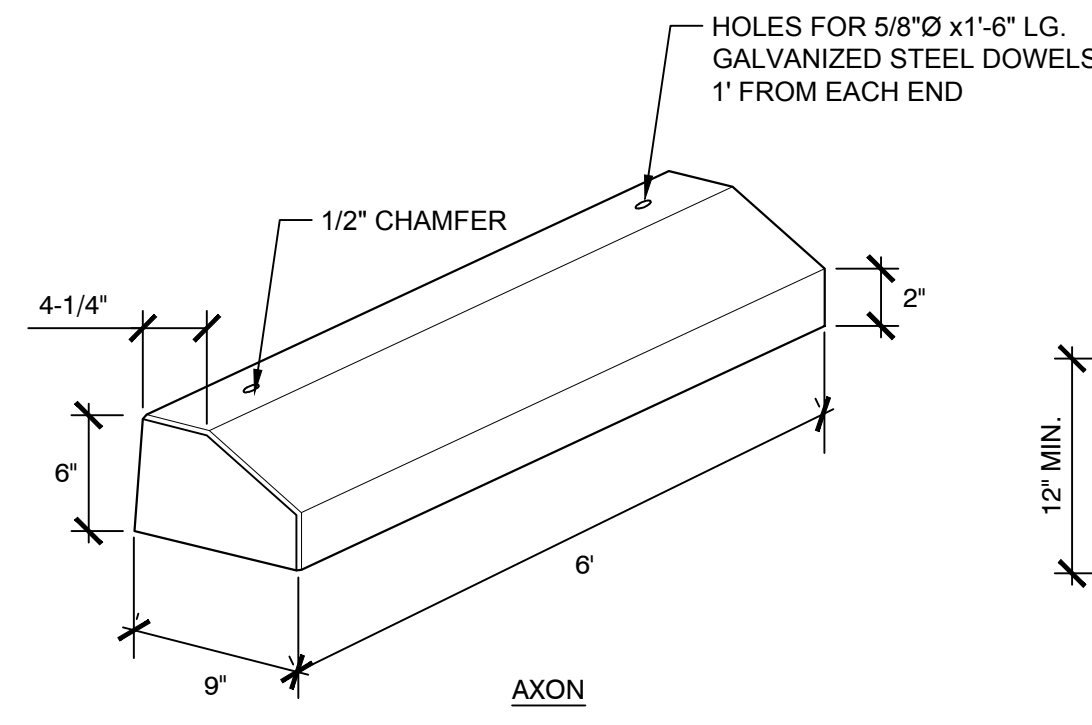
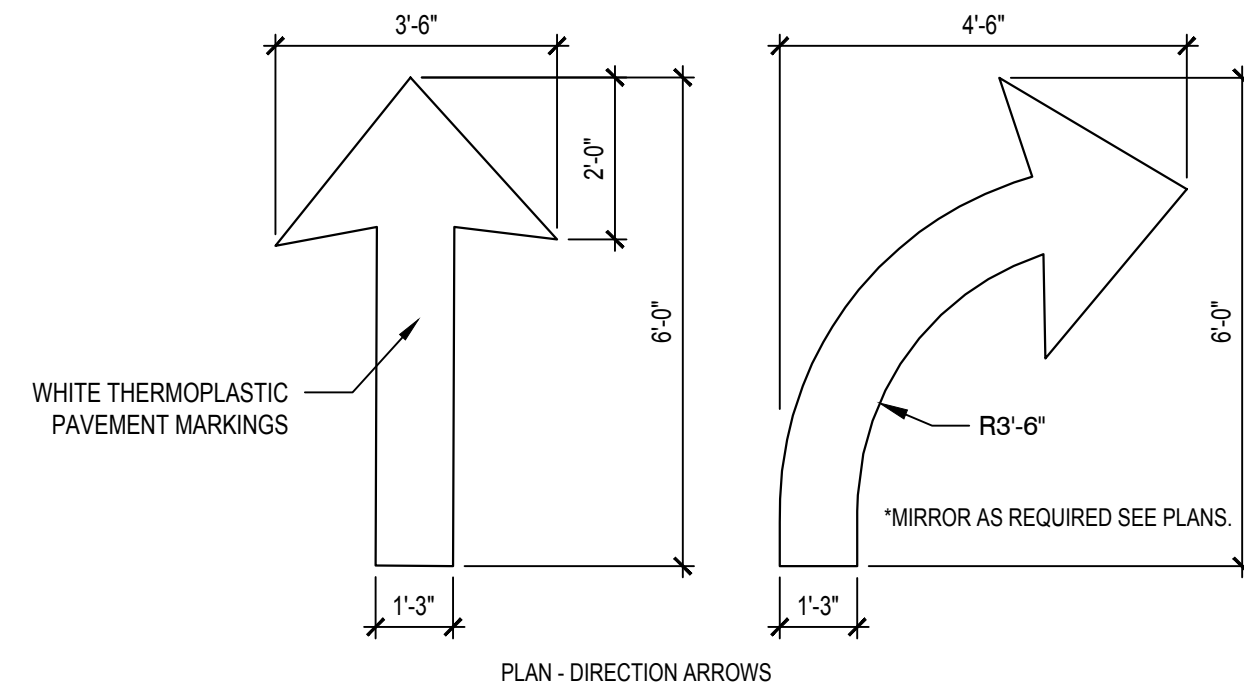
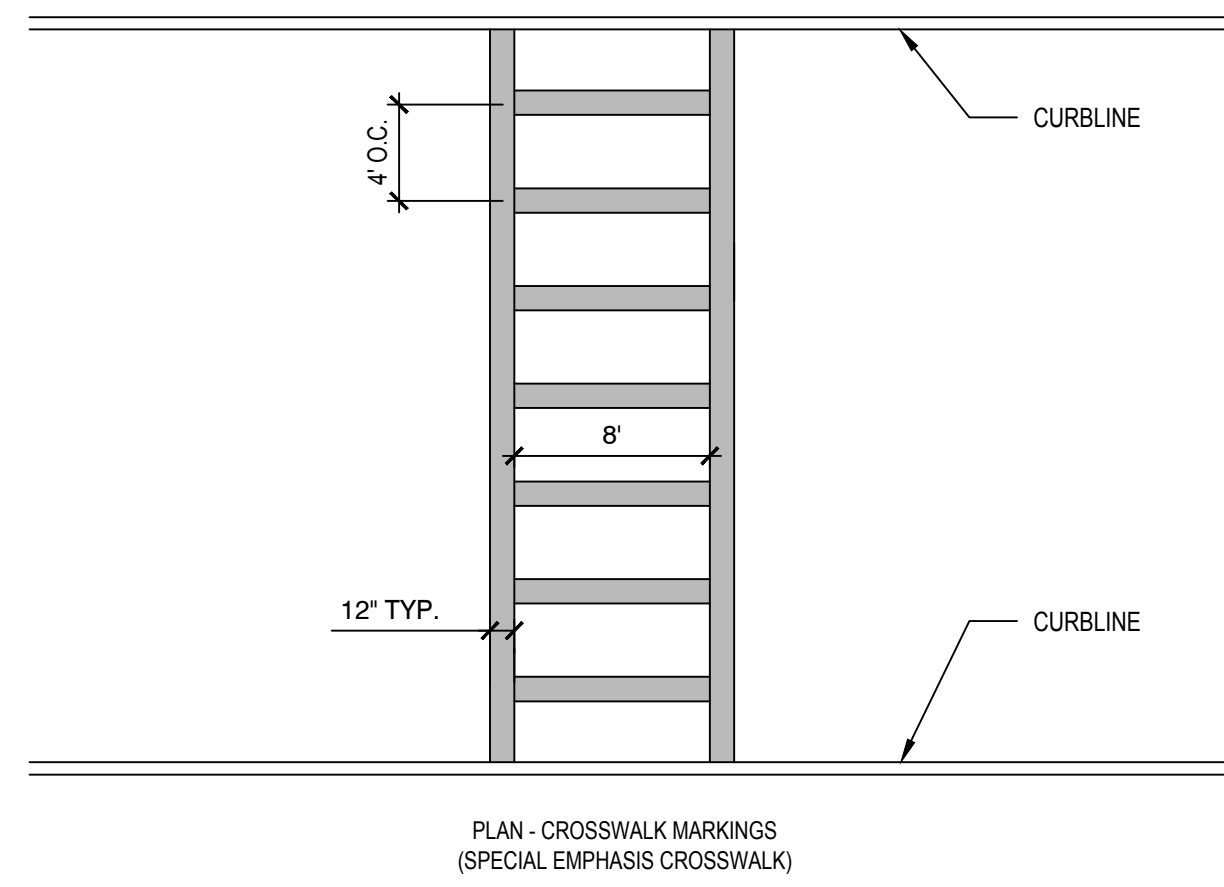

- NOTES:
- ALL 12\"/>

- NOTES:
- MINIMUM REINFORCING 4 - #3 BARS, FULL LENGTH
 - MINIMUM WEIGHT PER FOOT - 44 LBS.
 - CURBING TO BE DOWELED TO ASPHALT PAVING.
 - DOWELS TO BE RECESSED 1\"/>

1 CROSSWALK PAVING MARKINGS
SCALE: N.T.S.

2 ROADWAY PAVEMENT MARKINGS
SCALE: N.T.S.

3 PRECAST CONCRETE WHEEL STOP
SCALE: N.T.S.

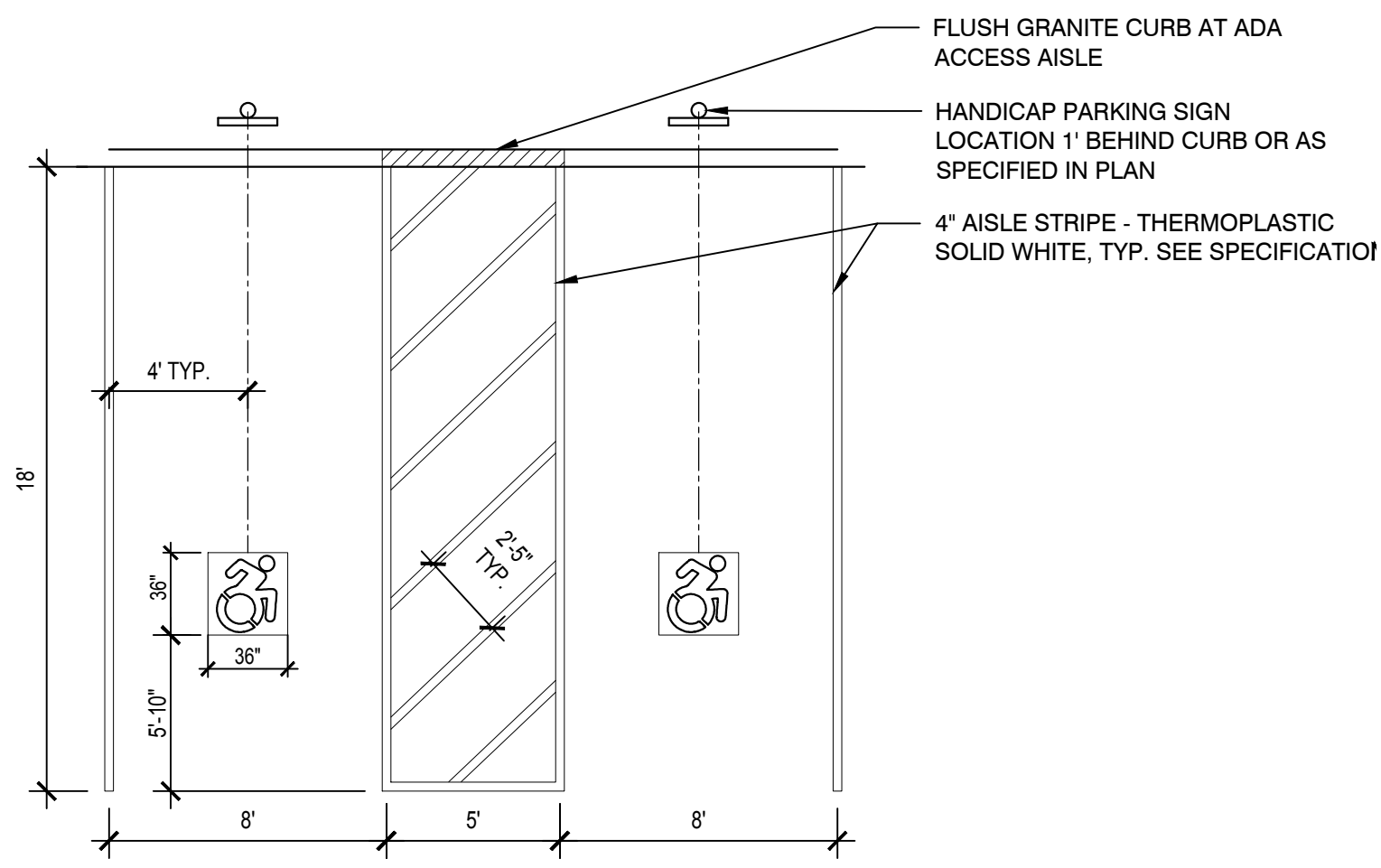
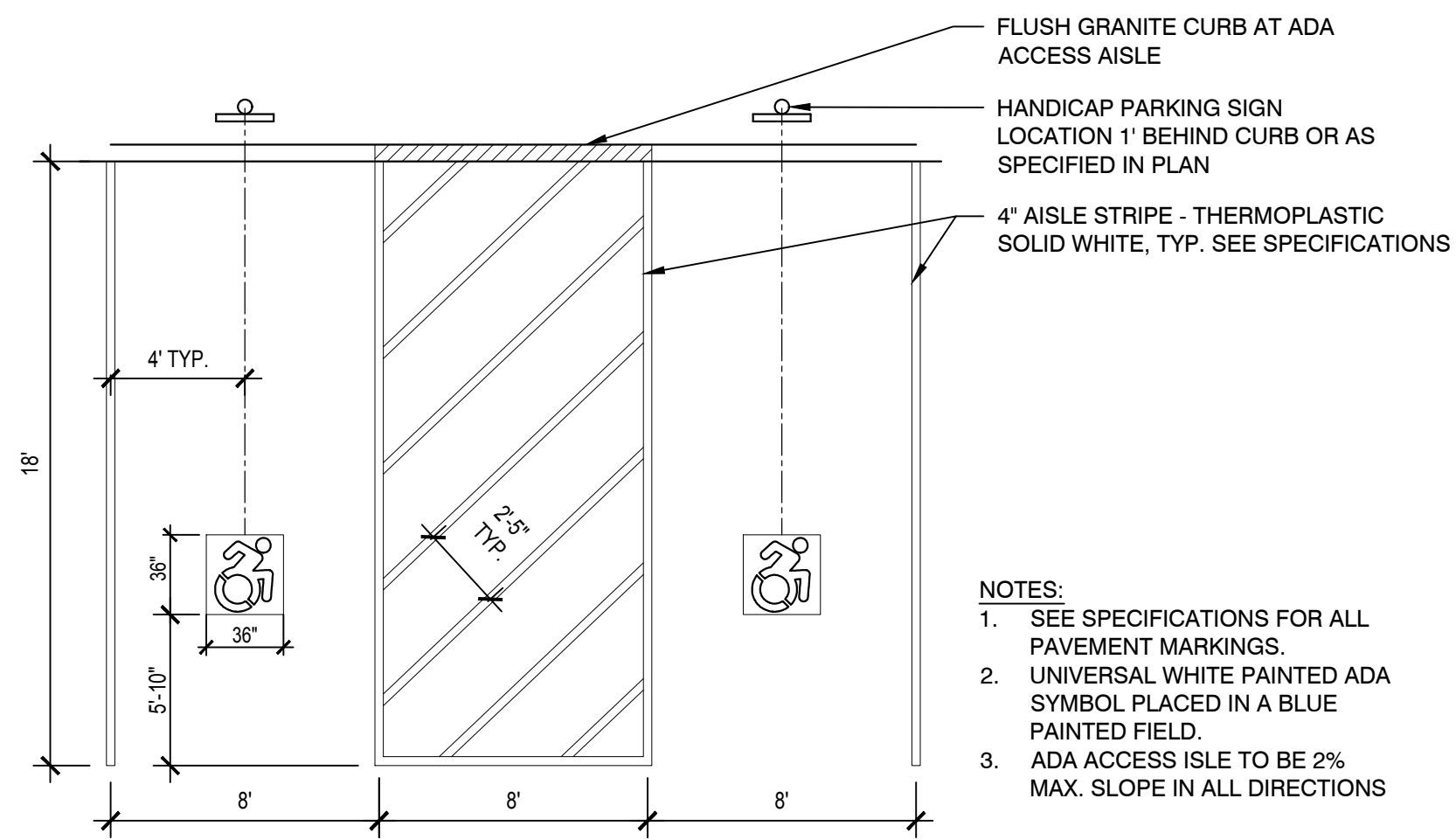

- NOTES:
- SEE SPECIFICATIONS FOR ALL PAVEMENT MARKINGS.
 - UNIVERSAL WHITE PAINTED ADA SYMBOL PLACED IN A BLUE PAINTED FIELD.
 - ADA ACCESS ISLE TO BE 2% MAX. SLOPE IN ALL DIRECTIONS

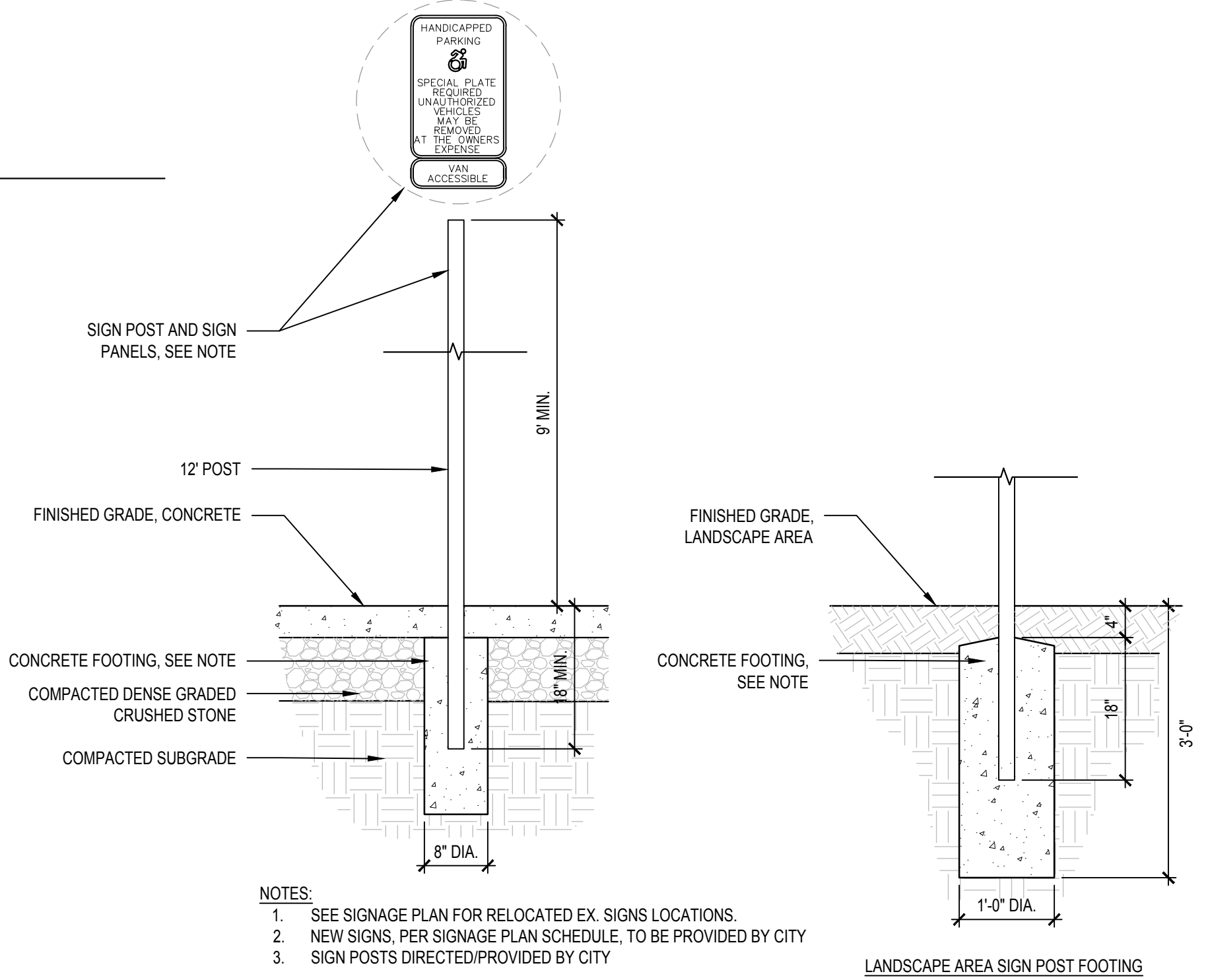

- NOTES:
- SEE SIGNAGE PLAN FOR RELOCATED EX. SIGNS LOCATIONS.
 - NEW SIGNS, PER SIGNAGE PLAN SCHEDULE, TO BE PROVIDED BY CITY
 - SIGN POSTS DIRECTED/PROVIDED BY CITY

- CONCRETE FOOTING SHALL CONSIST OF:
- ONE (1) PART HIGH EARLY STRENGTH CEMENT
 - ONE AND ONE HALF (1 1/2) PARTS CLEAN, SHARP SAND.
 - THREE (3) PARTS COURSE AGGREGATE
 - CLEAN WATER TO FORM MIXTURE

4 HANDICAP PARKING
SCALE: N.T.S.

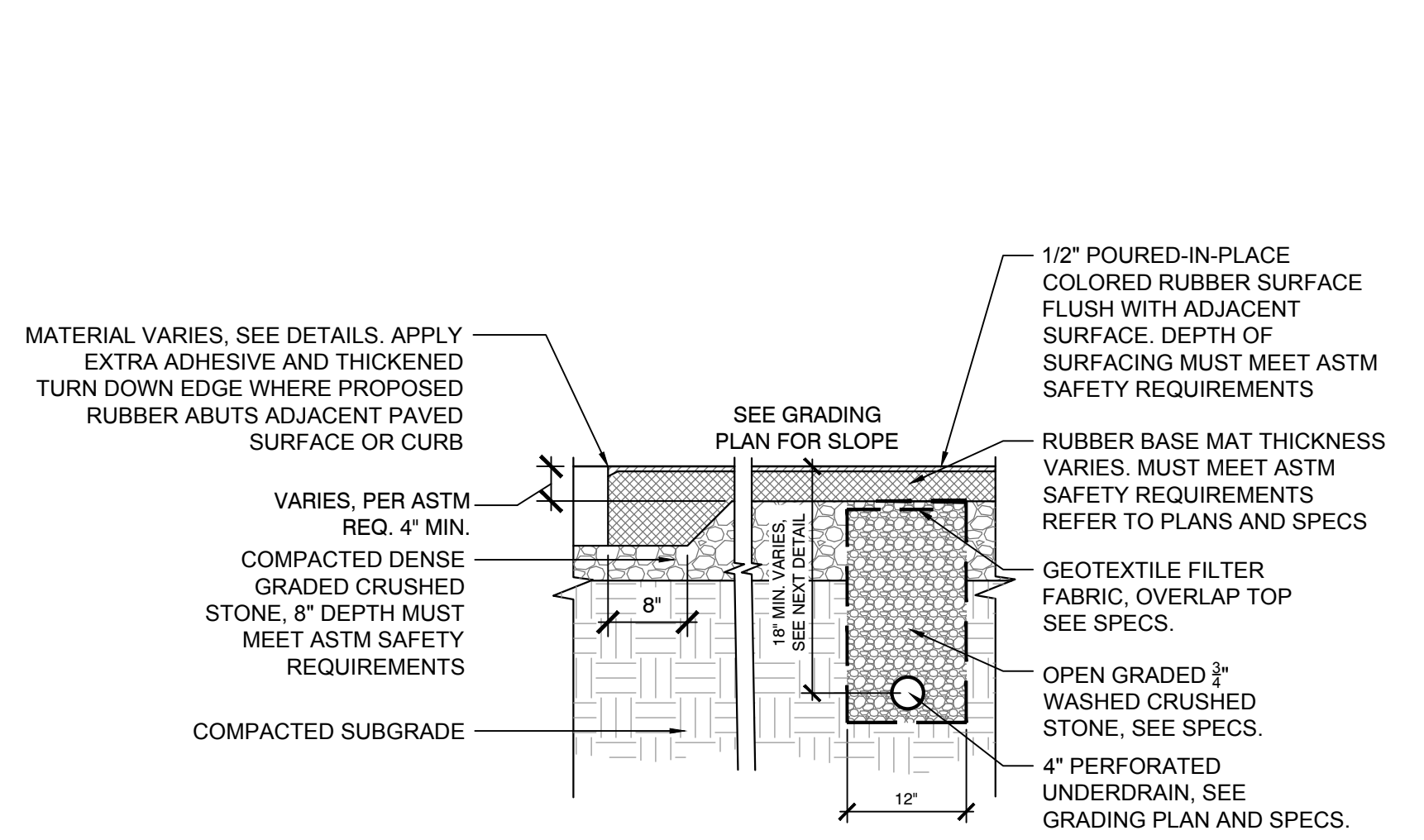

6 POURED-IN-PLACE RUBBER SAFETY SURFACING
SCALE: N.T.S.

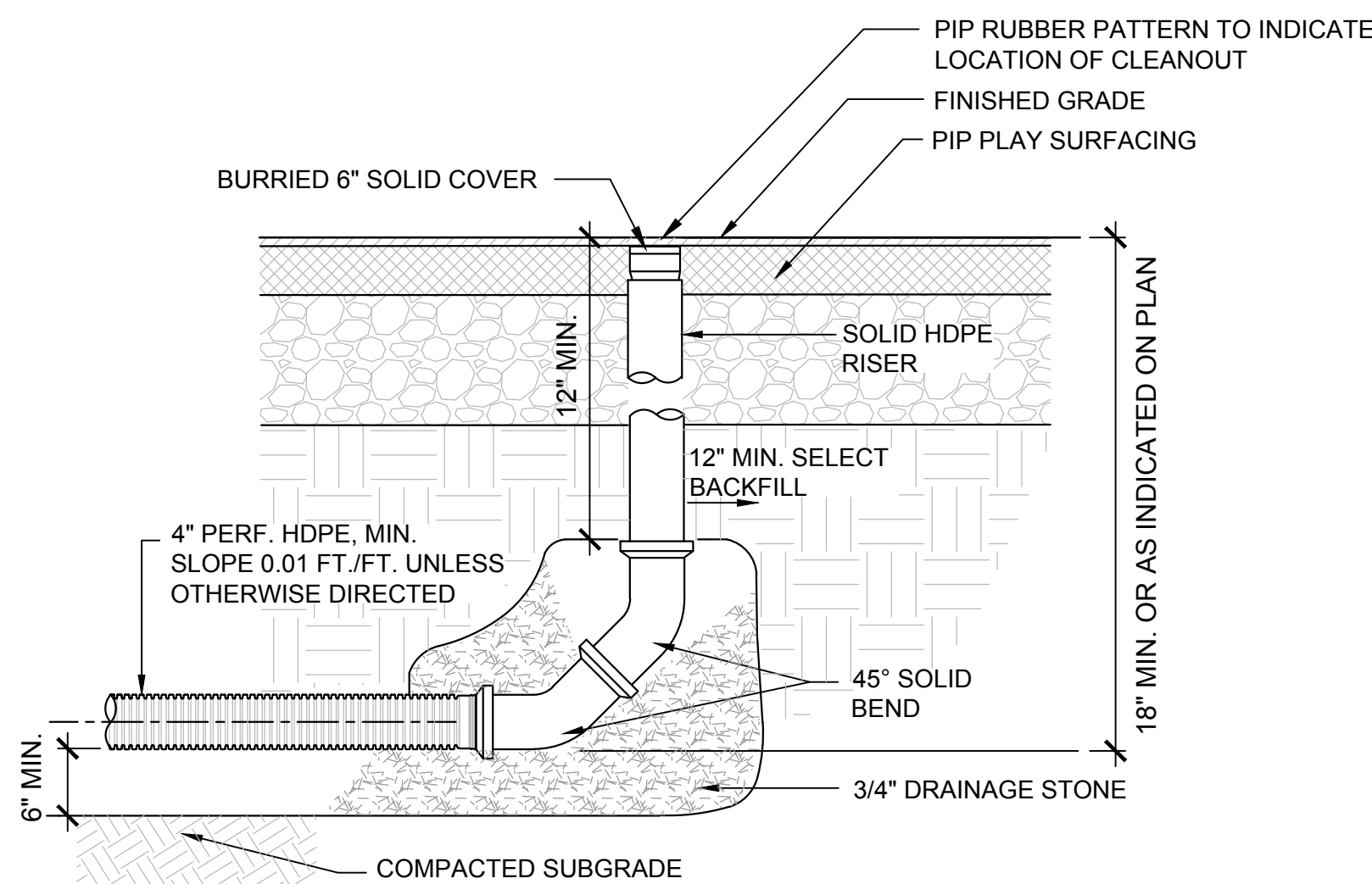

7 PVC CLEANOUT AT PLAYGROUND
SCALE: N.T.S.

5 ROADWAY AND PARKING LOT SIGNAGE
SCALE: N.T.S.

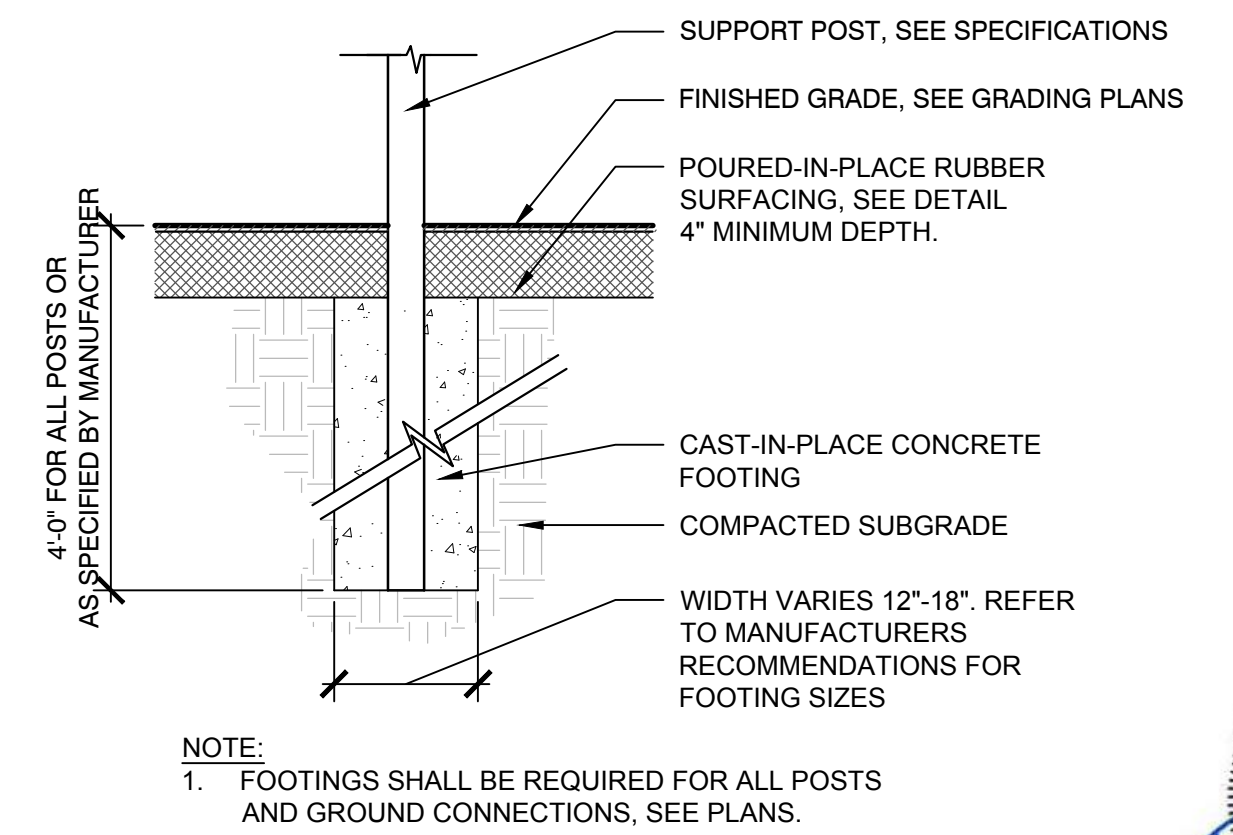

- NOTE:
- FOOTINGS SHALL BE REQUIRED FOR ALL POSTS AND GROUND CONNECTIONS, SEE PLANS.

8 PLAY EQUIPMENT FOOTING
SCALE: N.T.S.



Prepared By:

Weston & Sampson

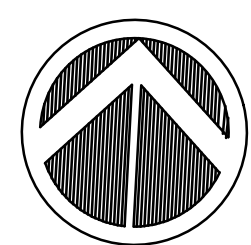

NORTH

No.	Date	Revision

Approved By: _____ Date: _____

Project Name.:

**IMPROVEMENTS TO
McCONNELL PARK**

BWSC SUBMISSION

Date	FEBRUARY 2021
Scale	
Drawn	ENB, LSR
Checked	CFR

Sheet Name.:

CONSTRUCTION
DETAILS

SHEET:

L7.06



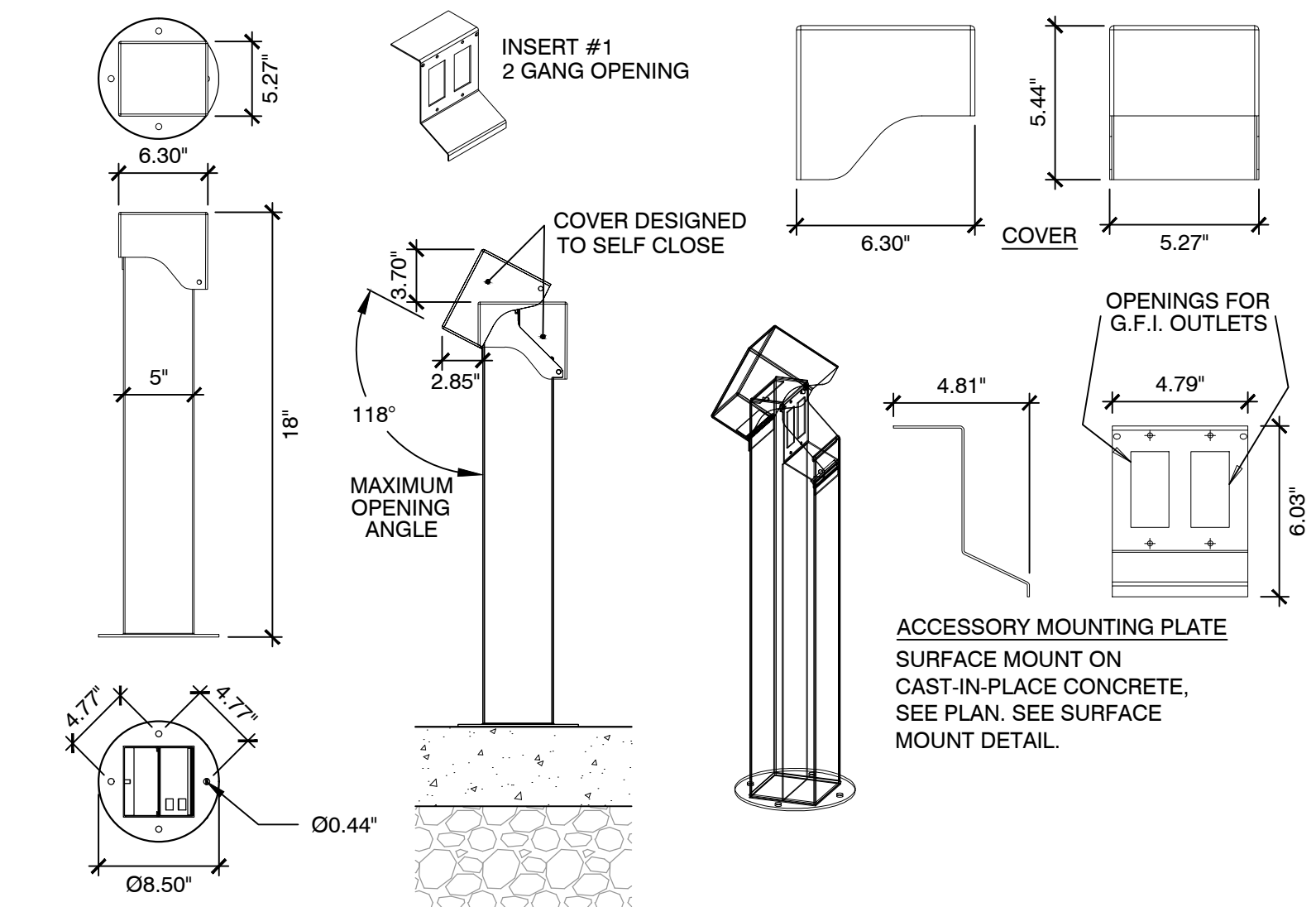
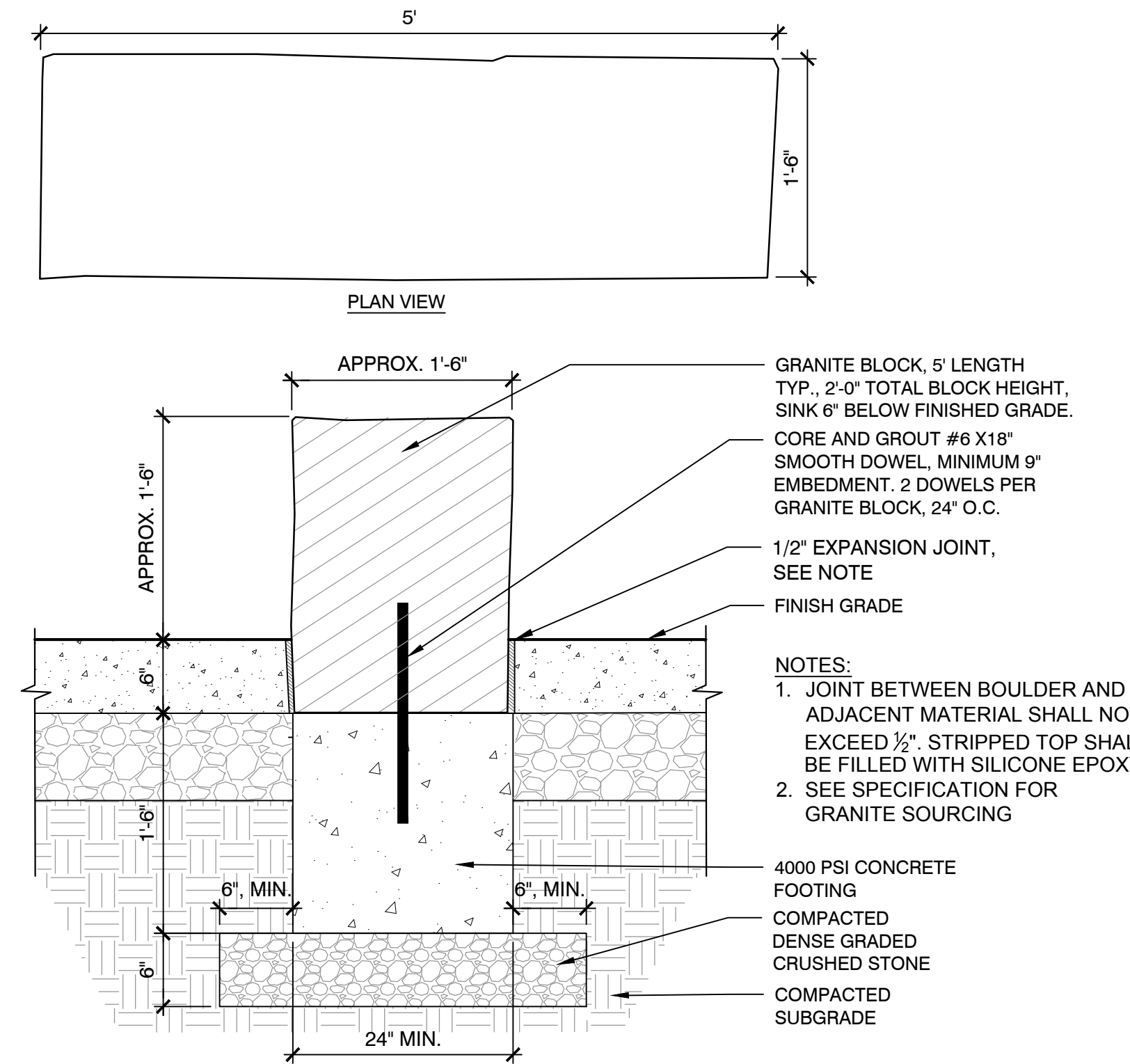
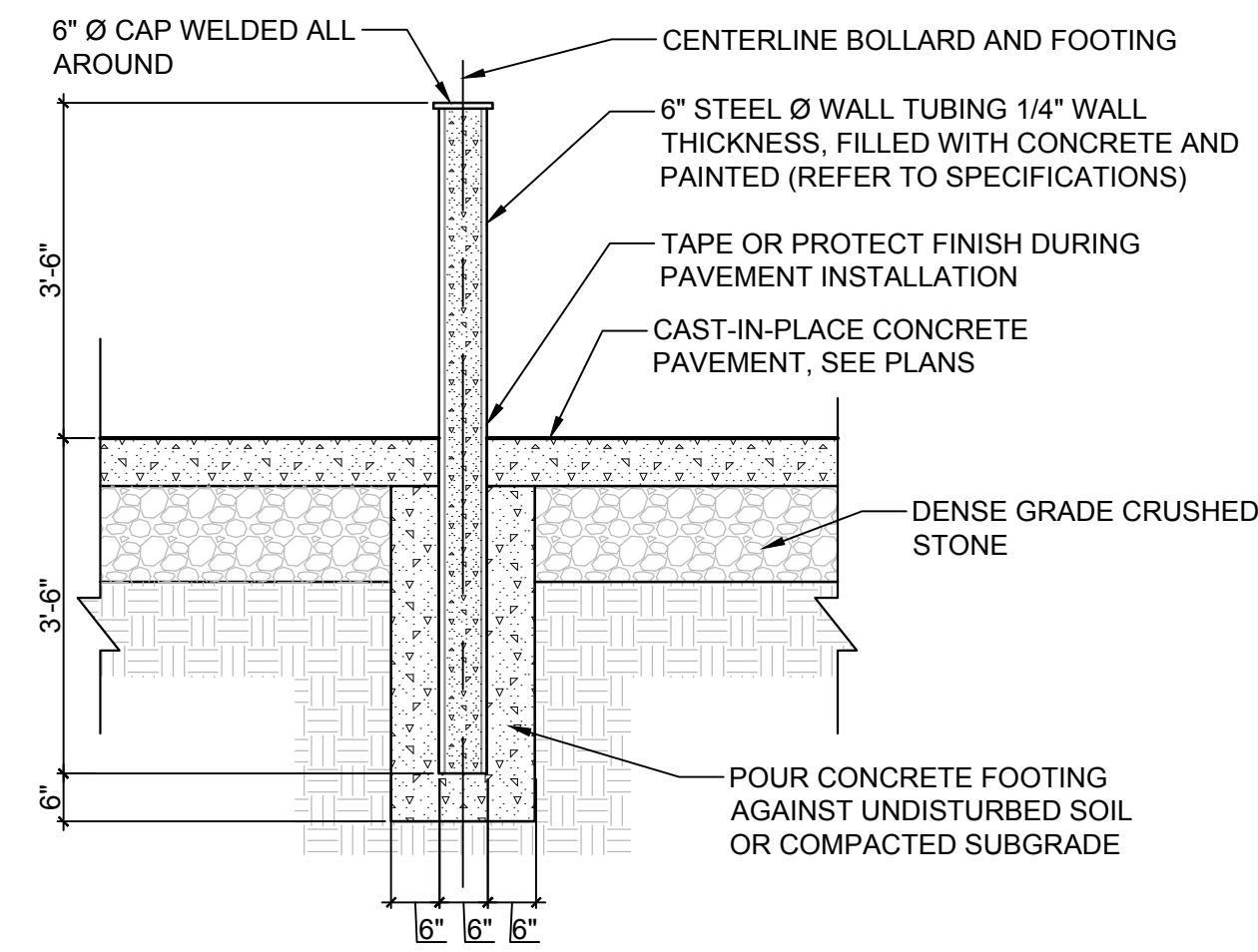

1 VEHICLE RATED BOLLARD
SCALE: N.T.S.

2 GRANITE BLOCK AT SPEED TABLE PLAZA
SCALE: N.T.S.

3 UTILITY BOLLARD
SCALE: N.T.S.

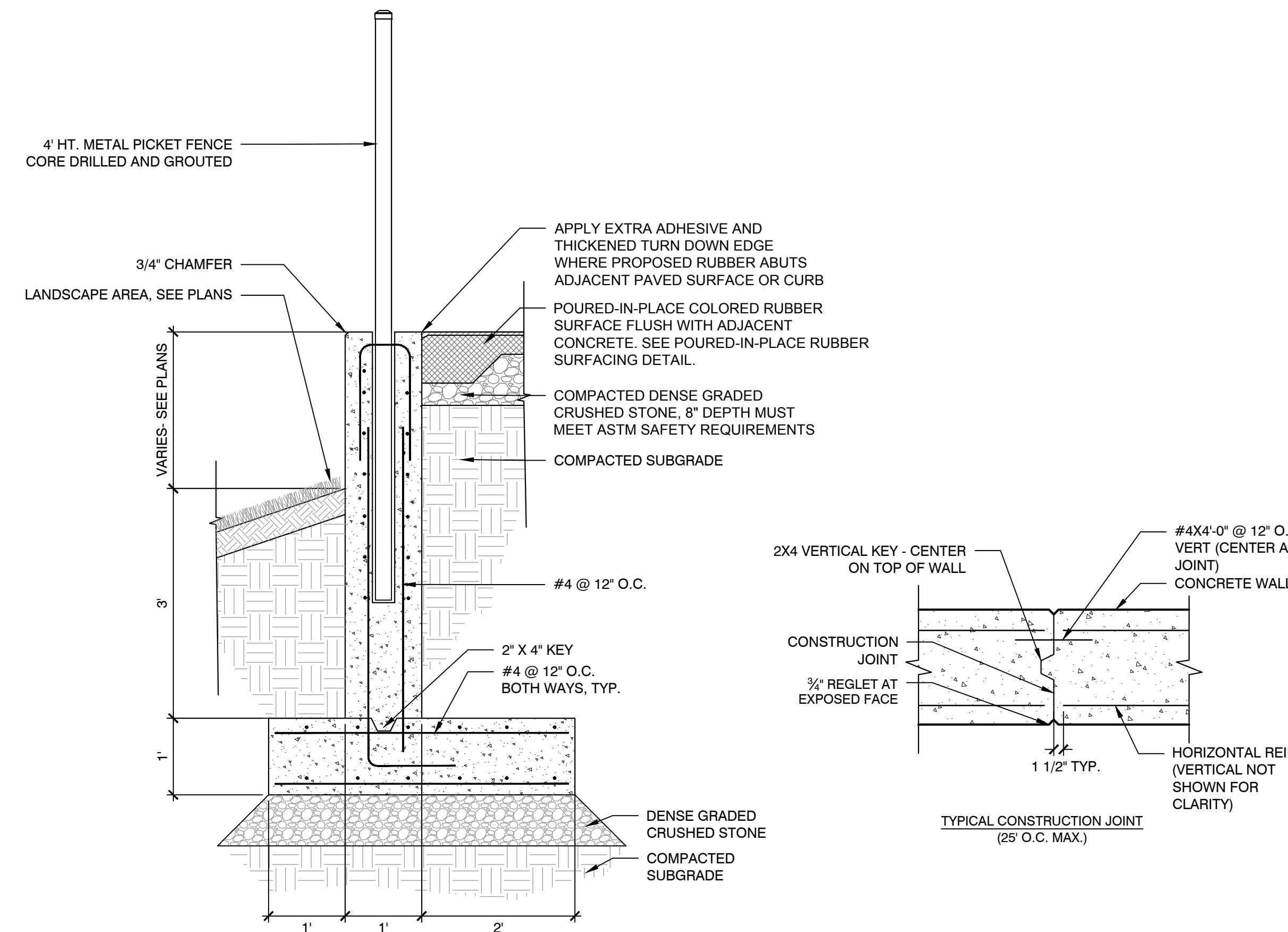
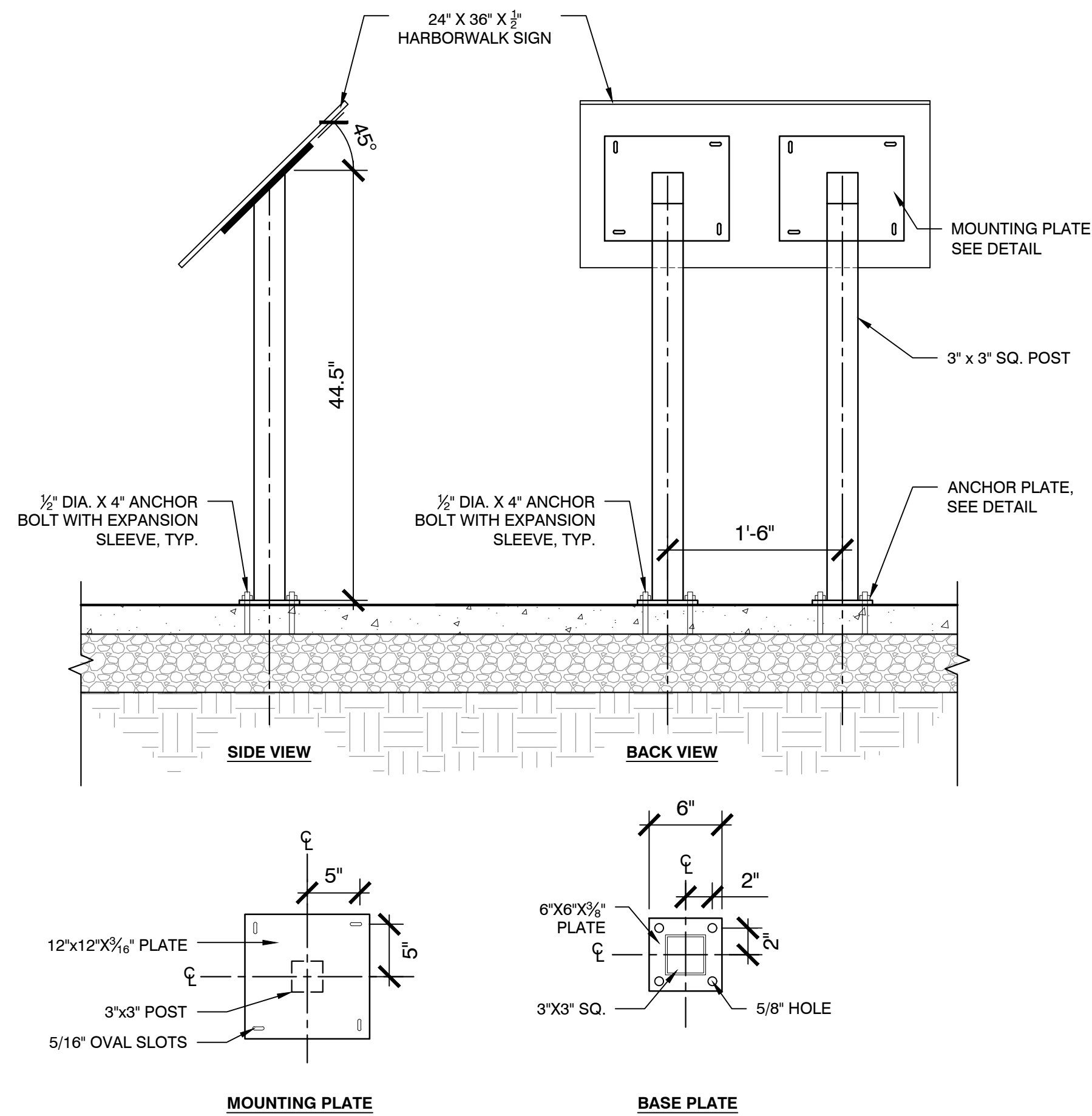

4 INTERPRETIVE SIGNAGE
SCALE: N.T.S.

5 RETAINING WALL
SCALE: N.T.S.



Prepared By:

Weston & Sampson

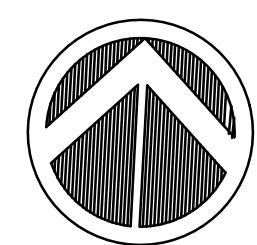

NORTH

No.	Date	Revision

Approved By:

Date:

Project Name.:

**IMPROVEMENTS TO
McCONNELL PARK**

BWSC SUBMISSION

Date FEBRUARY 2021

Scale

Drawn

Checked

ENB, LSR

CFR

Sheet Name.:

CONSTRUCTION
DETAILS

SHEET:

L7.07

Consultant Project No. 2160850

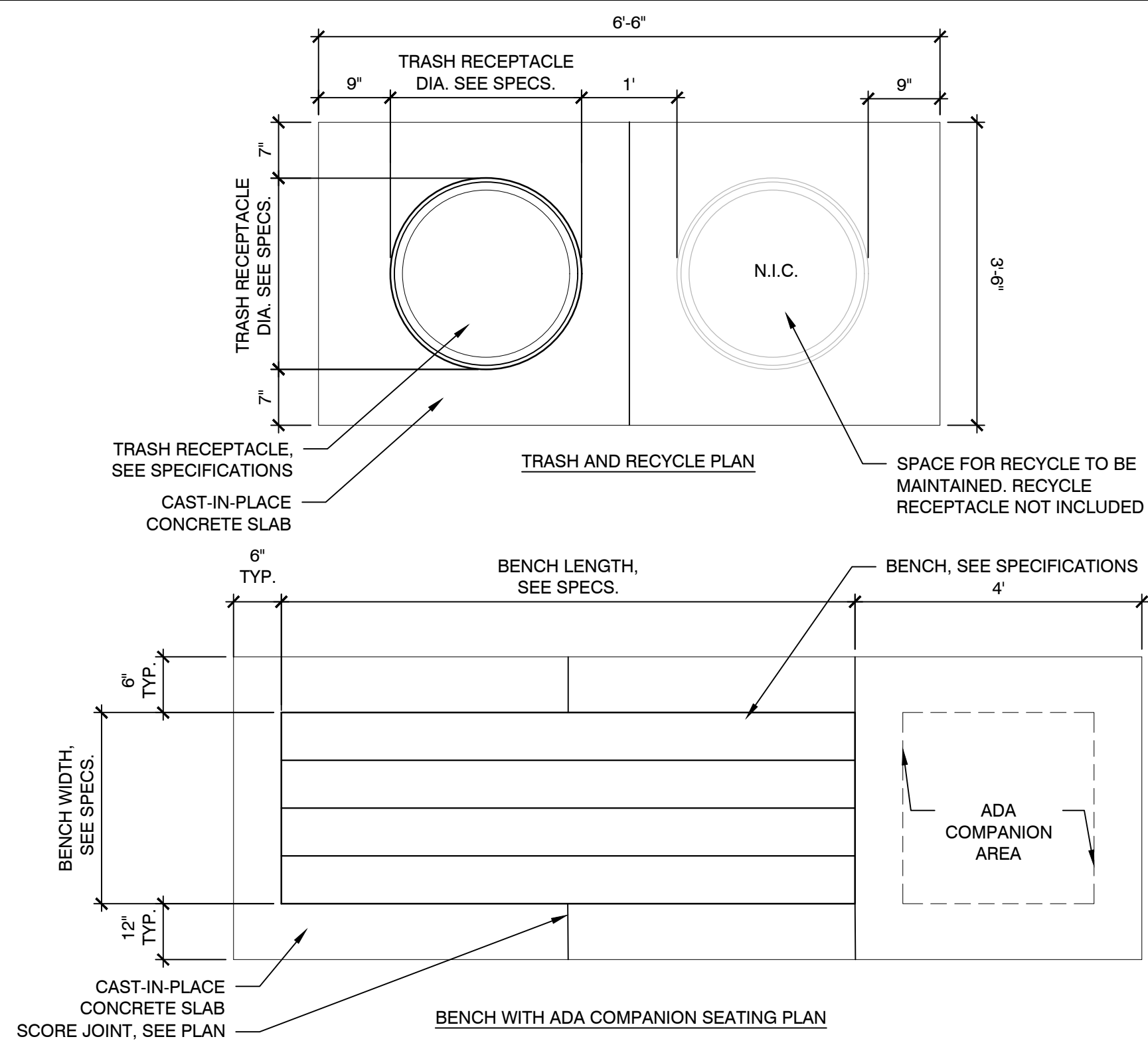

1 CONCRETE PAD FOR SITE FURNITURE MOUNT
SCALE: N.T.S.

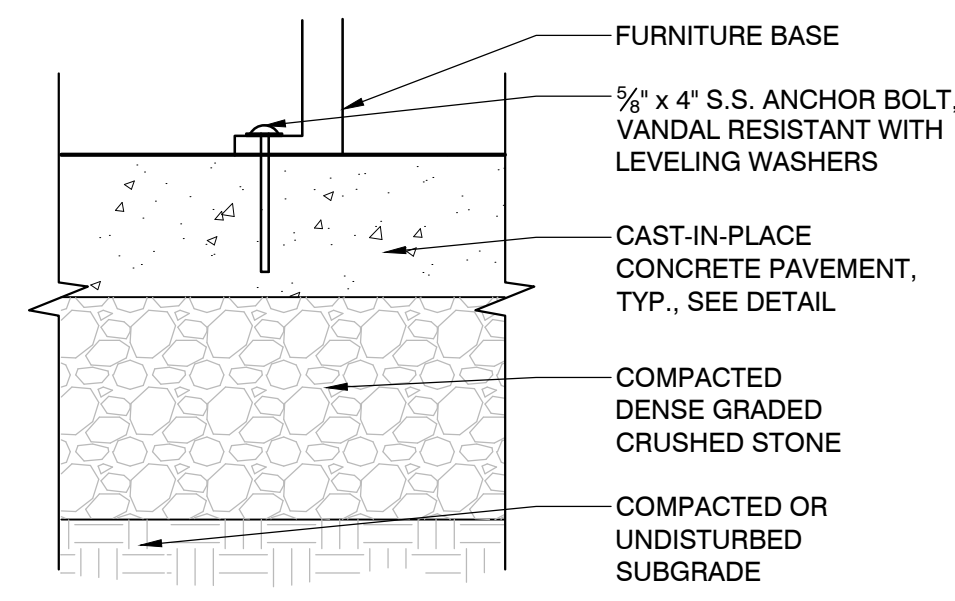

2 FURNITURE SURFACE MOUNT
SCALE: N.T.S.

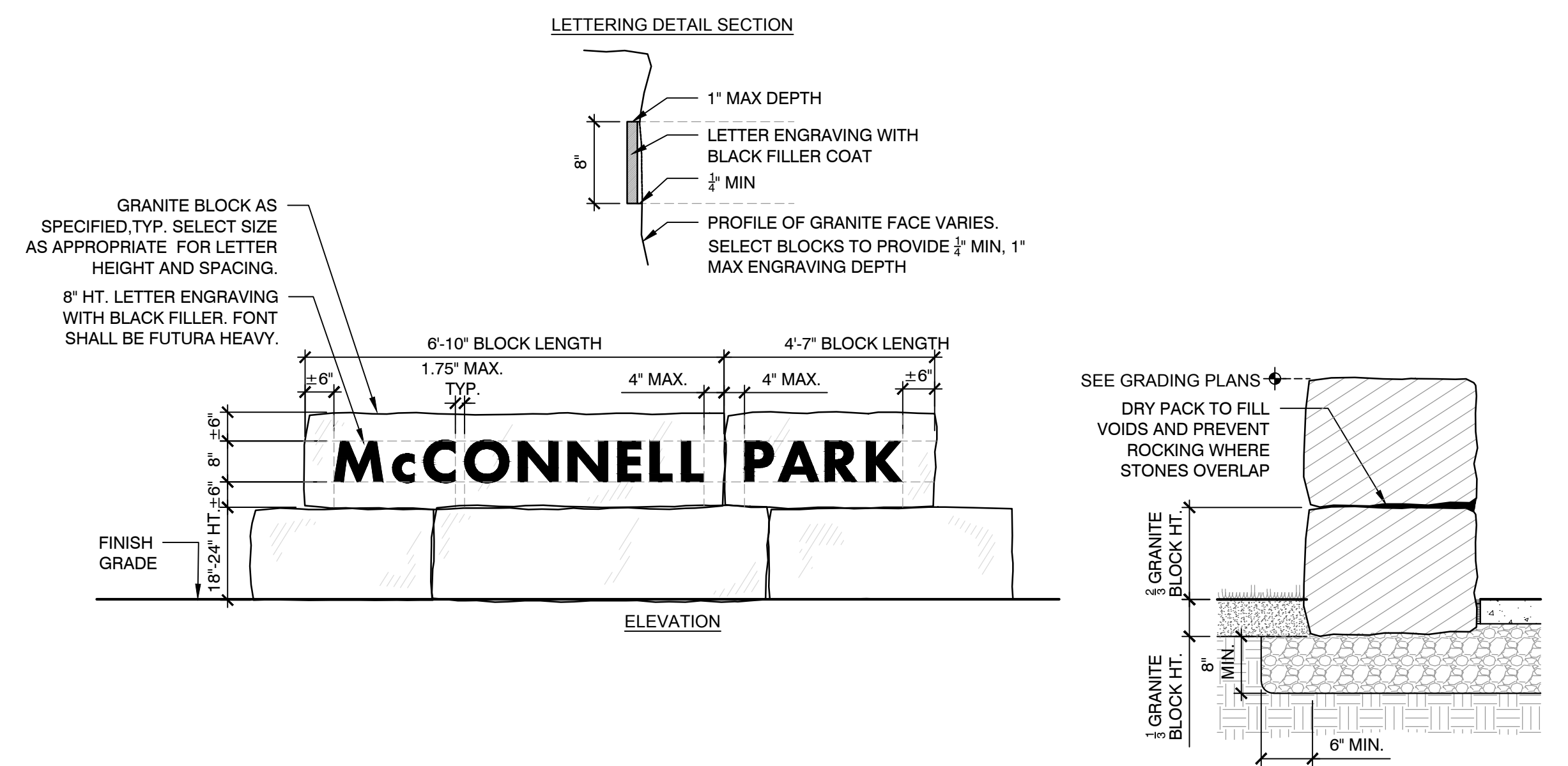

3 PARK SIGN ON GRANITE BLOCKS
SCALE: N.T.S.

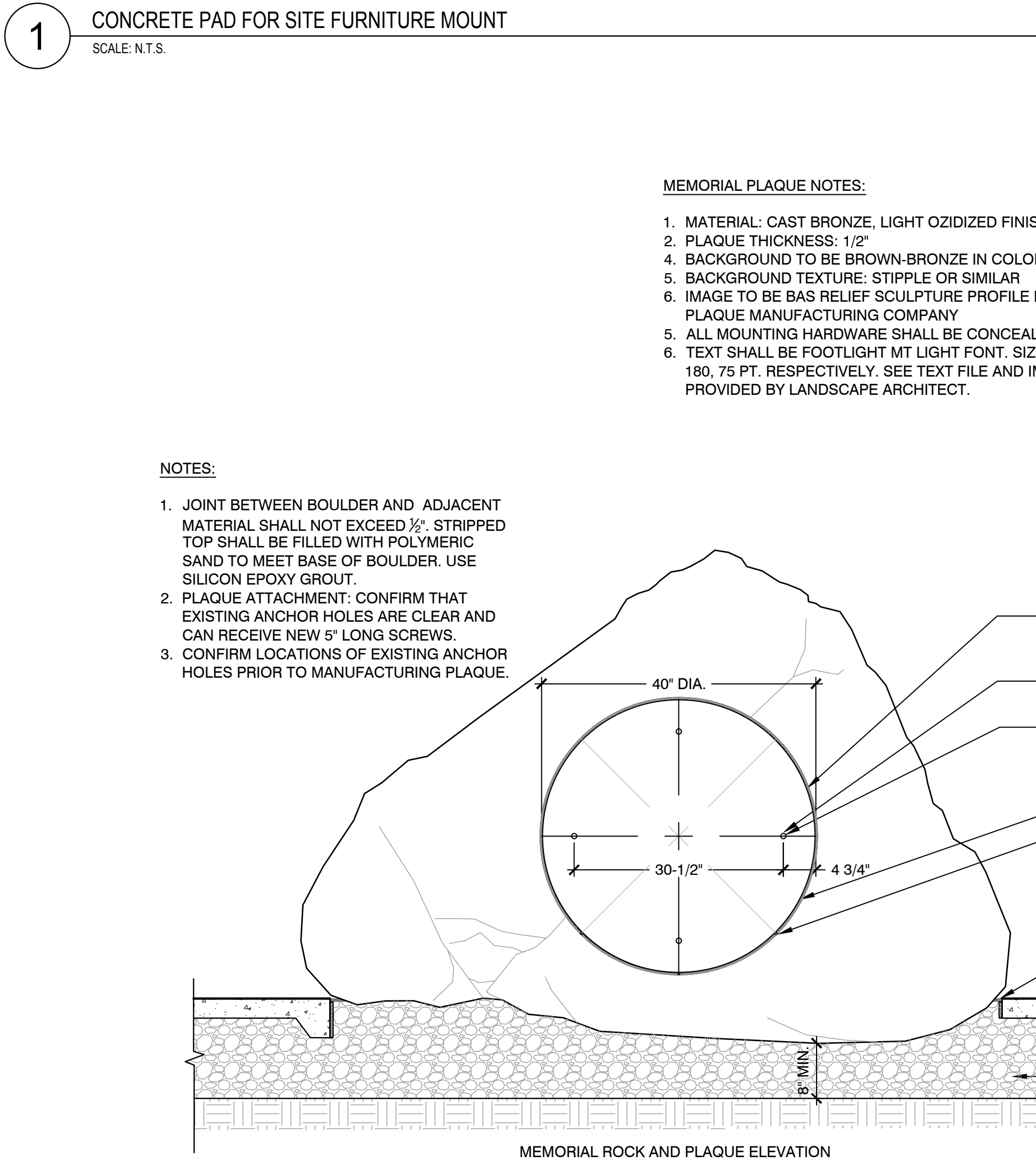

4 RESET MEMORIAL BOULDER W/ NEW BRONZE PLAQUE
SCALE: N.T.S.

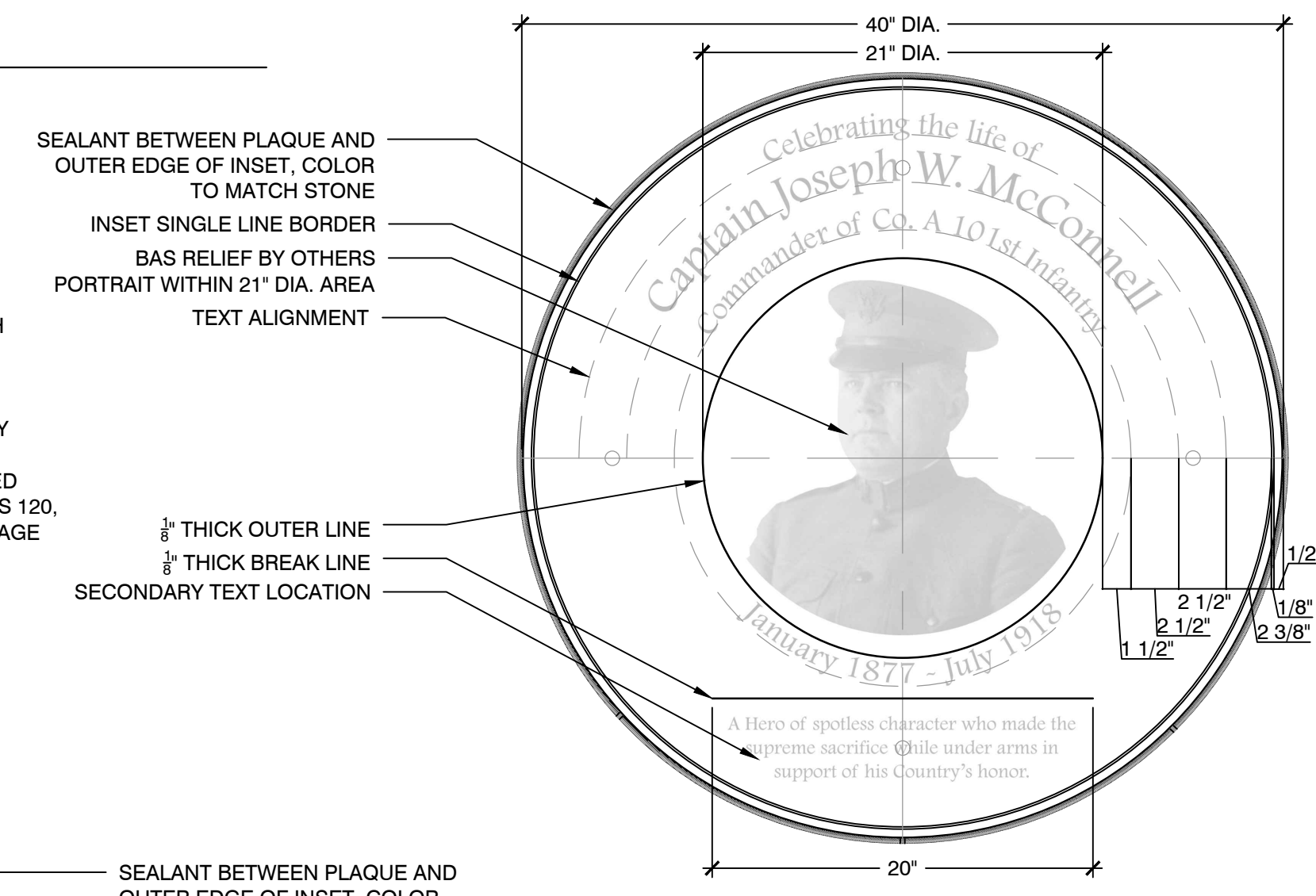

MEMORIAL PLAQUE ENLARGEMENT

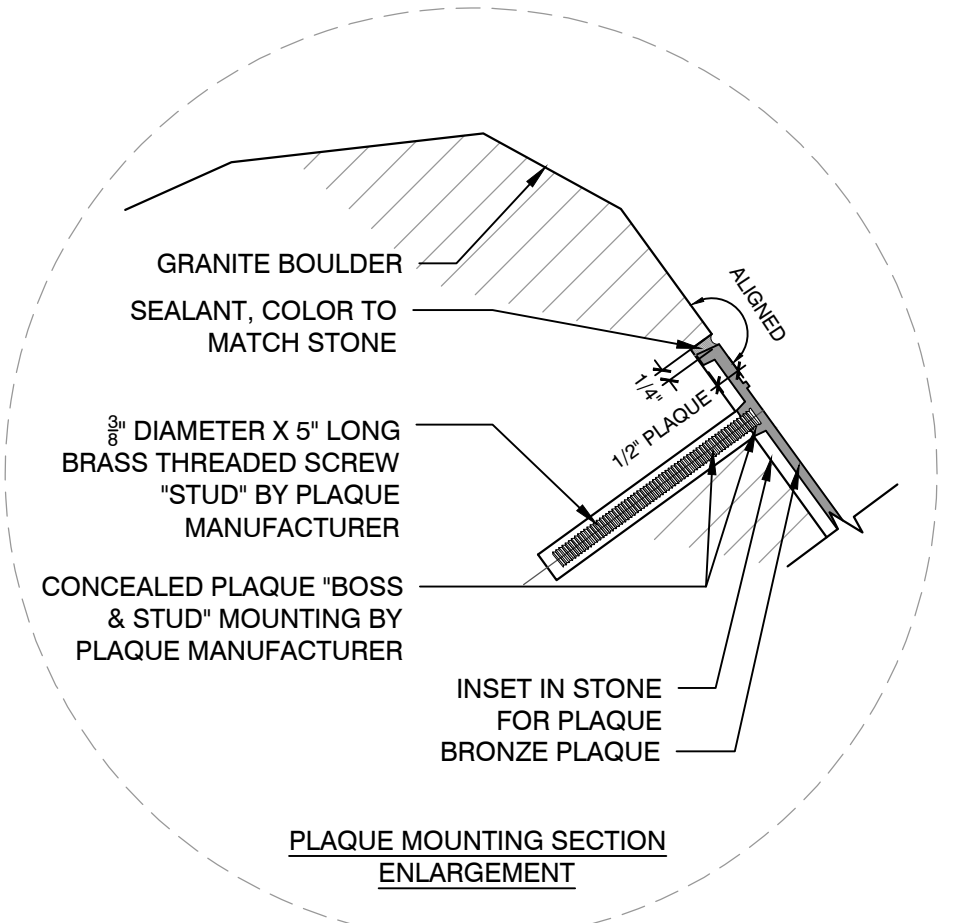

5 GRANITE BLOCK IN SLOPE
SCALE: N.T.S.

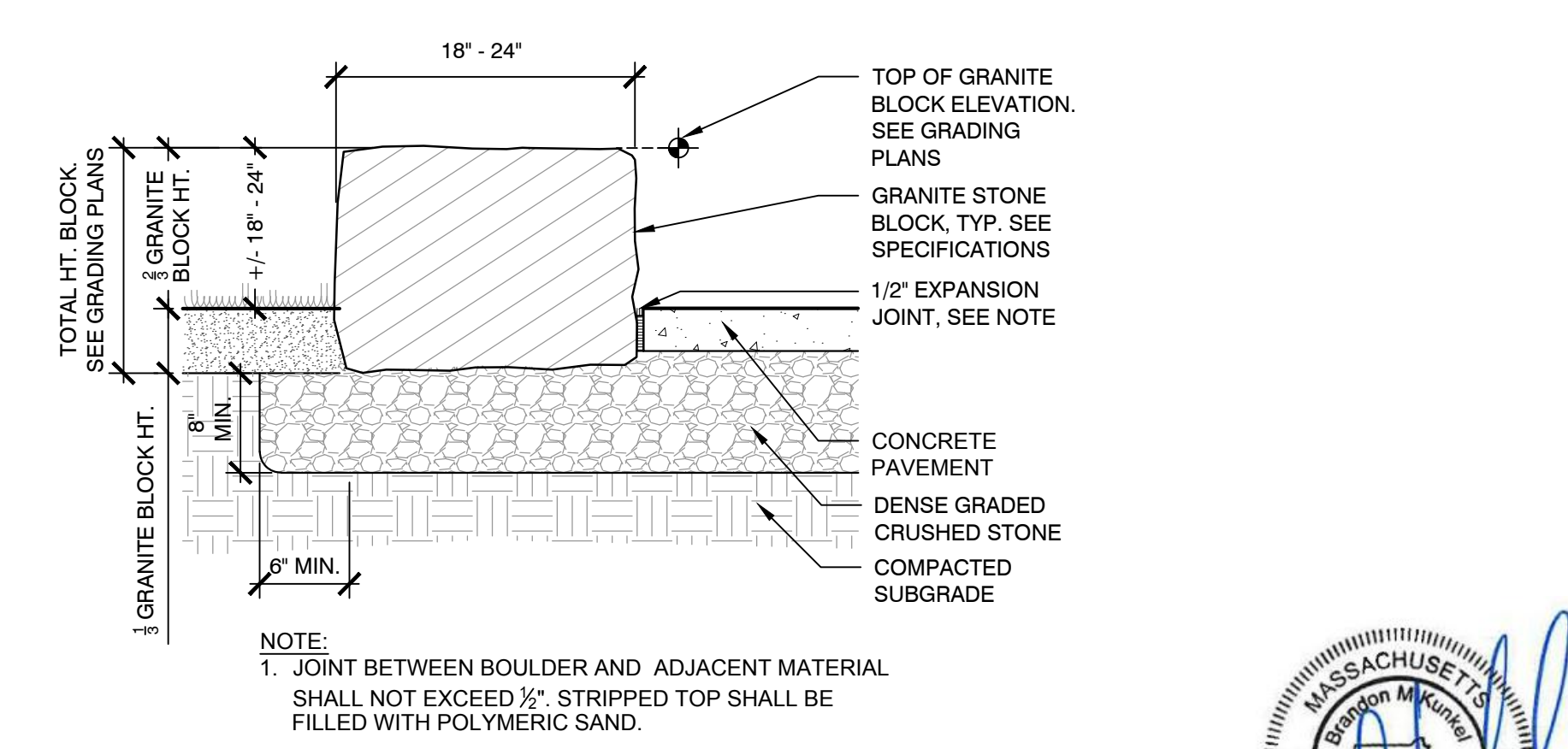

6 GRANITE BLOCK SEATWALL
SCALE: N.T.S.



Prepared By:
Weston & Sampson
Consultant Project No. 2160850



No.	Date	Revision

Approved By: _____ Date: _____

Project Name.: **IMPROVEMENTS TO McCONNELL PARK**

BWSC SUBMISSION
Date: FEBRUARY 2021
Scale: _____
Drawn: ENB, LSR
Checked: CFR

Sheet Name.: **CONSTRUCTION DETAILS**

SHEET: **L7.08**



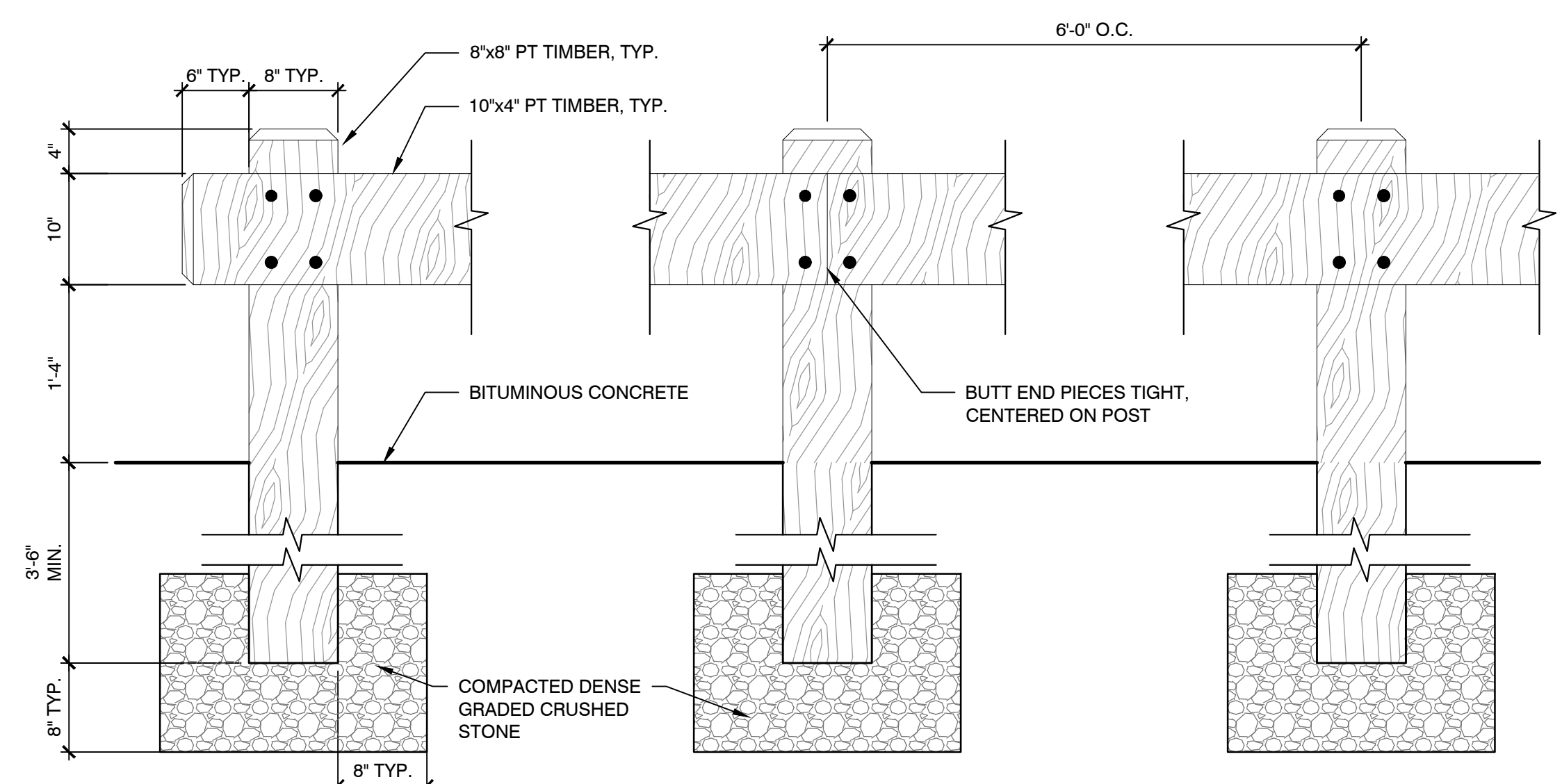
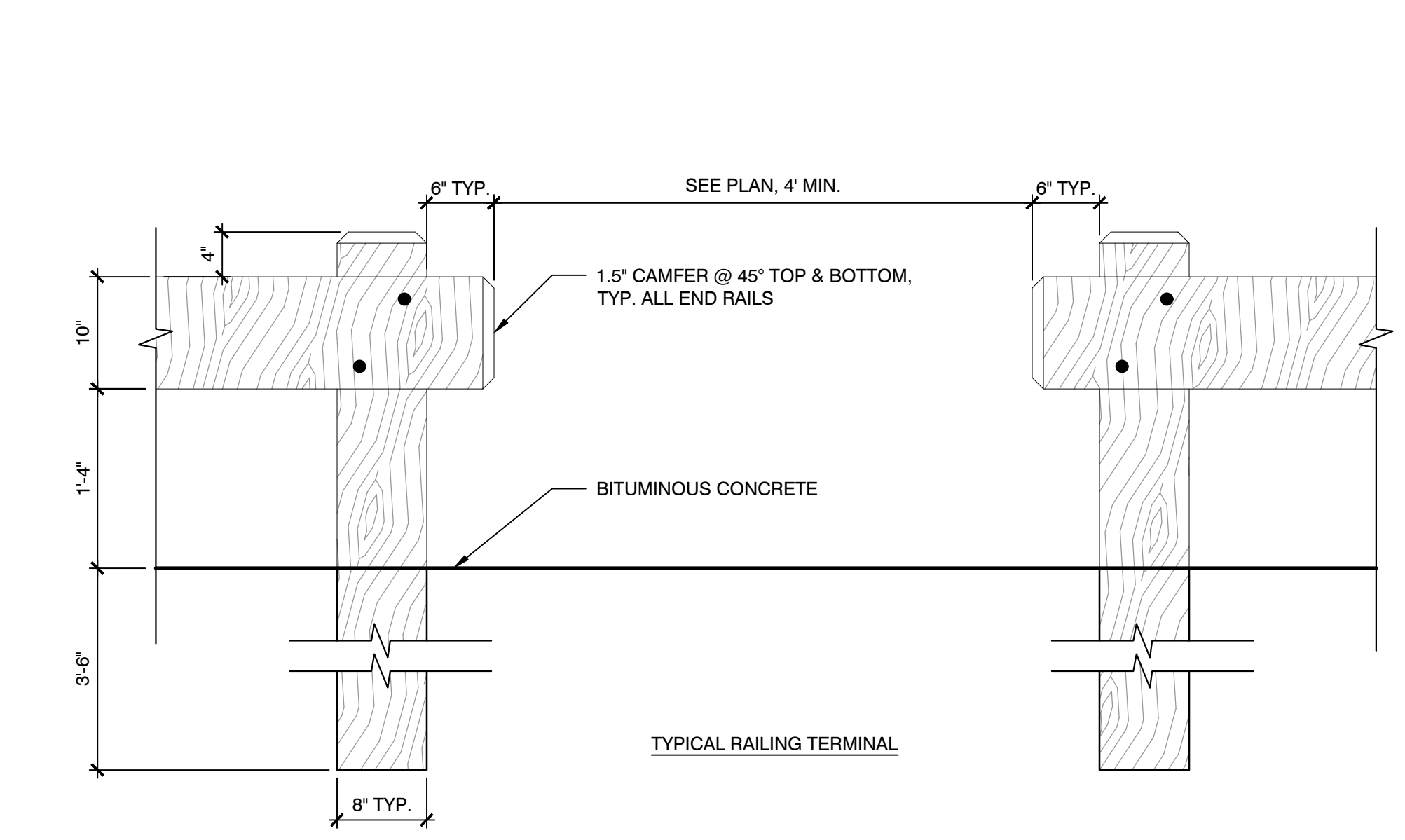

1 GUARD RAIL
SCALE: N.T.S.

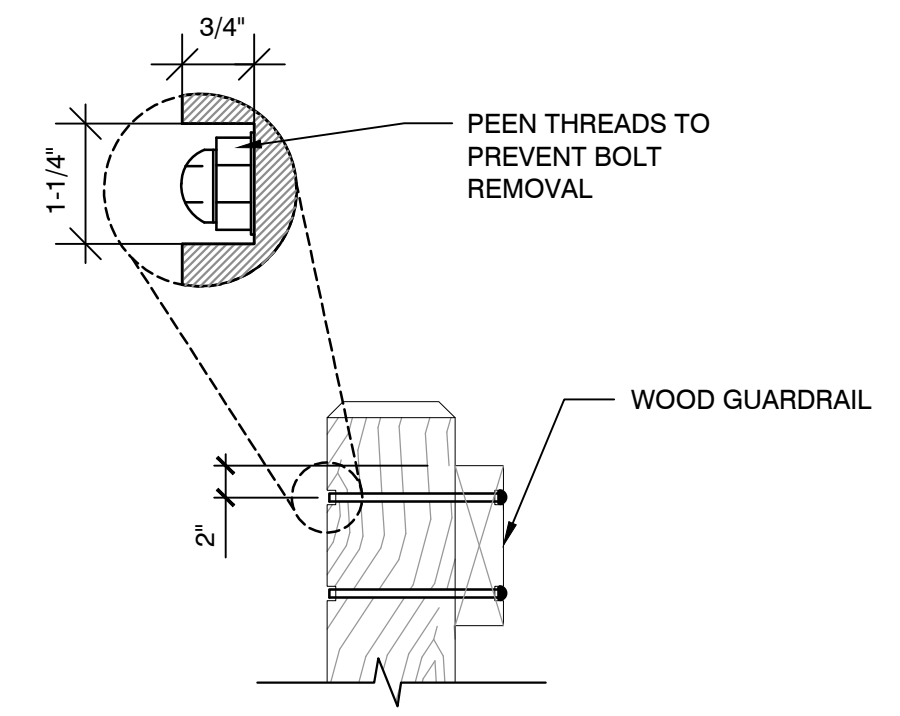
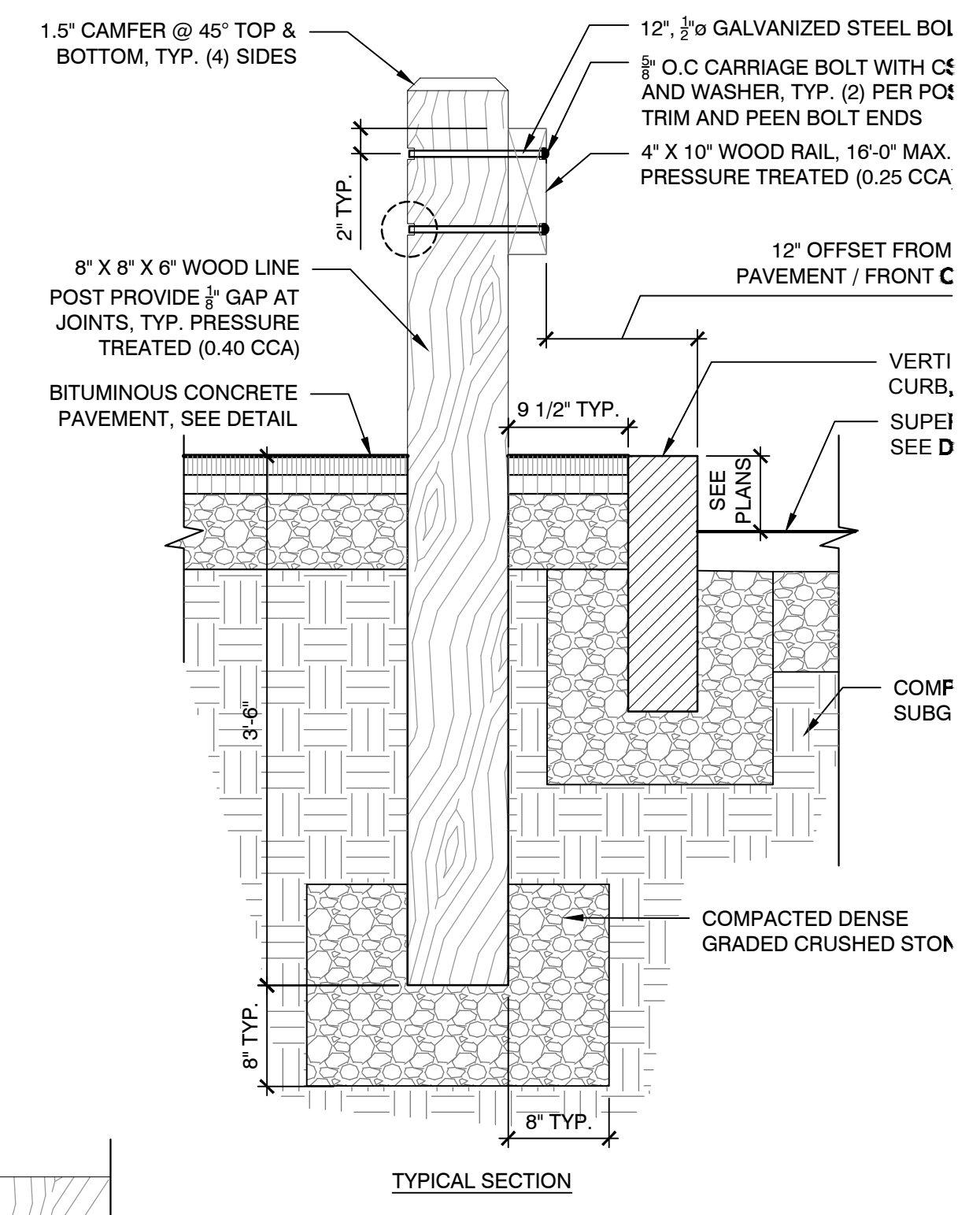

2 FENCE POST FOOTING IN CONCRETE
SCALE: N.T.S.

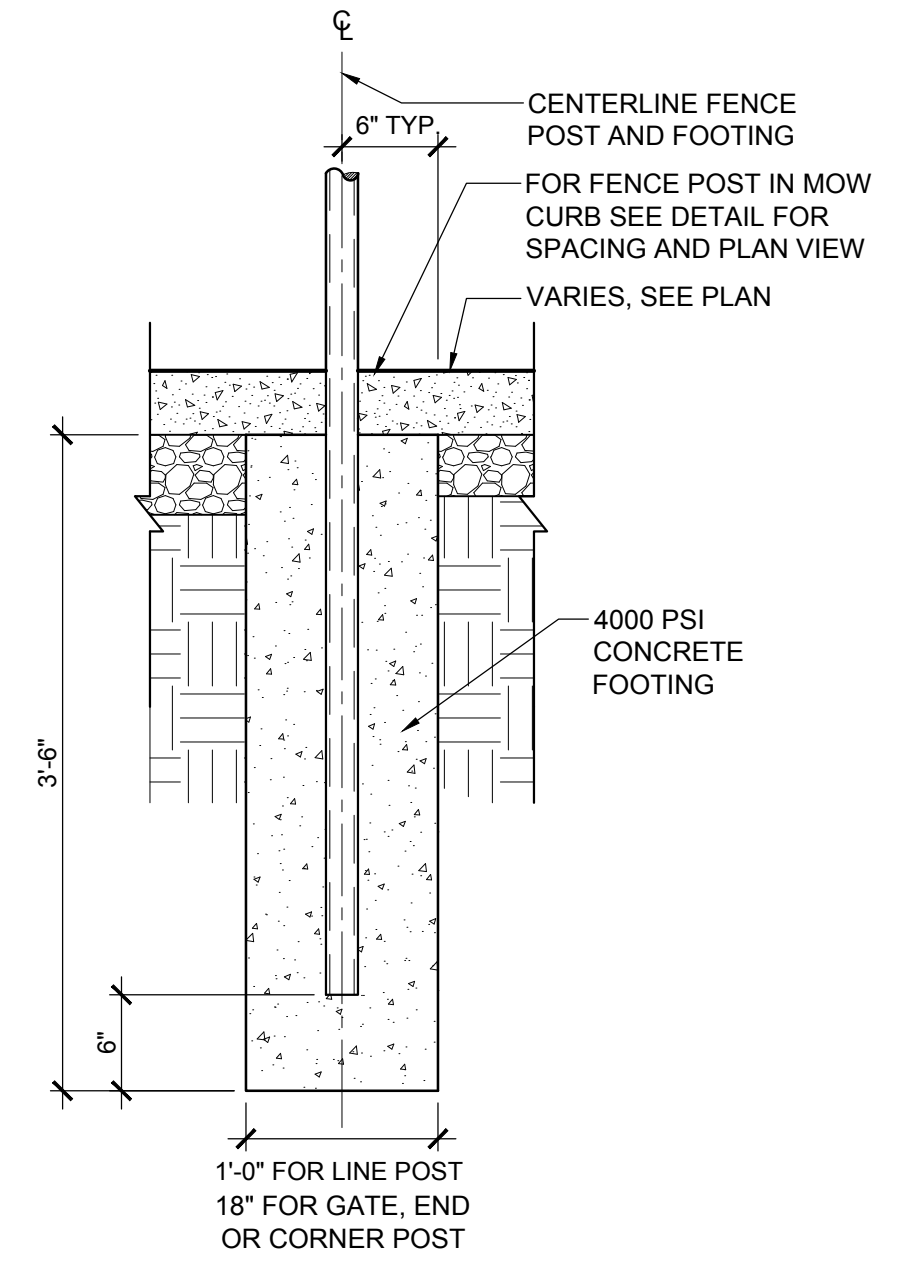

3 FENCE POST FOOTING IN LANDSCAPE
SCALE: N.T.S.

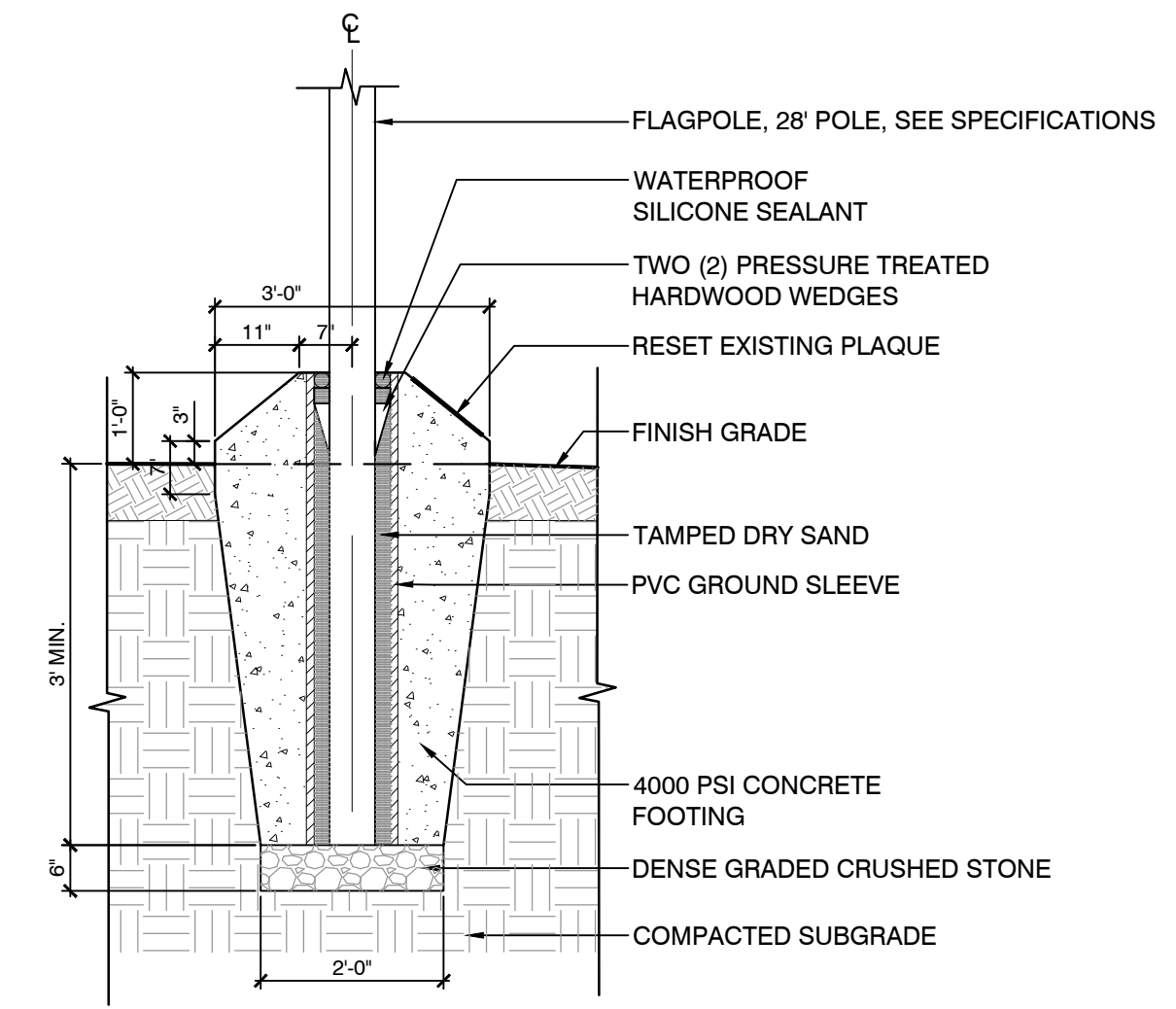
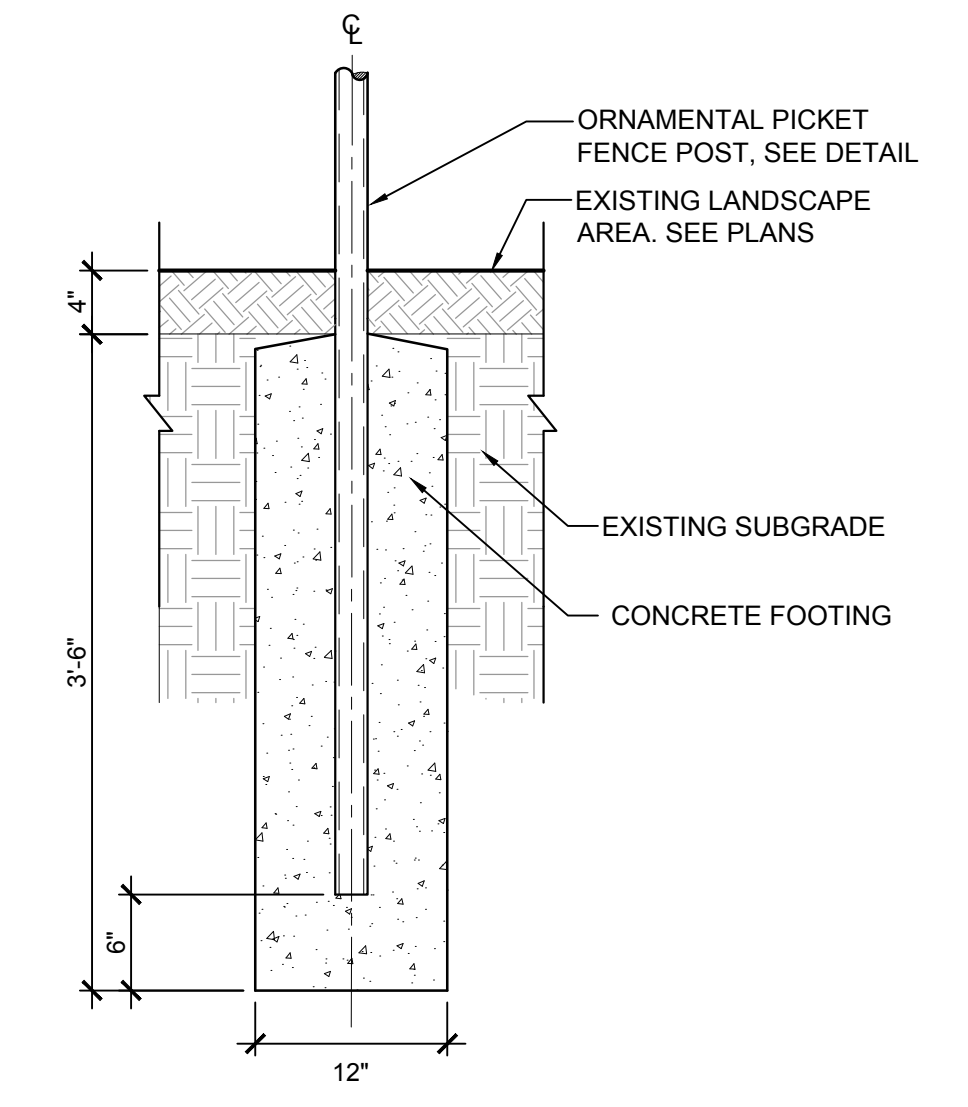

4 FLAG POLE FOOTING
SCALE: N.T.S.

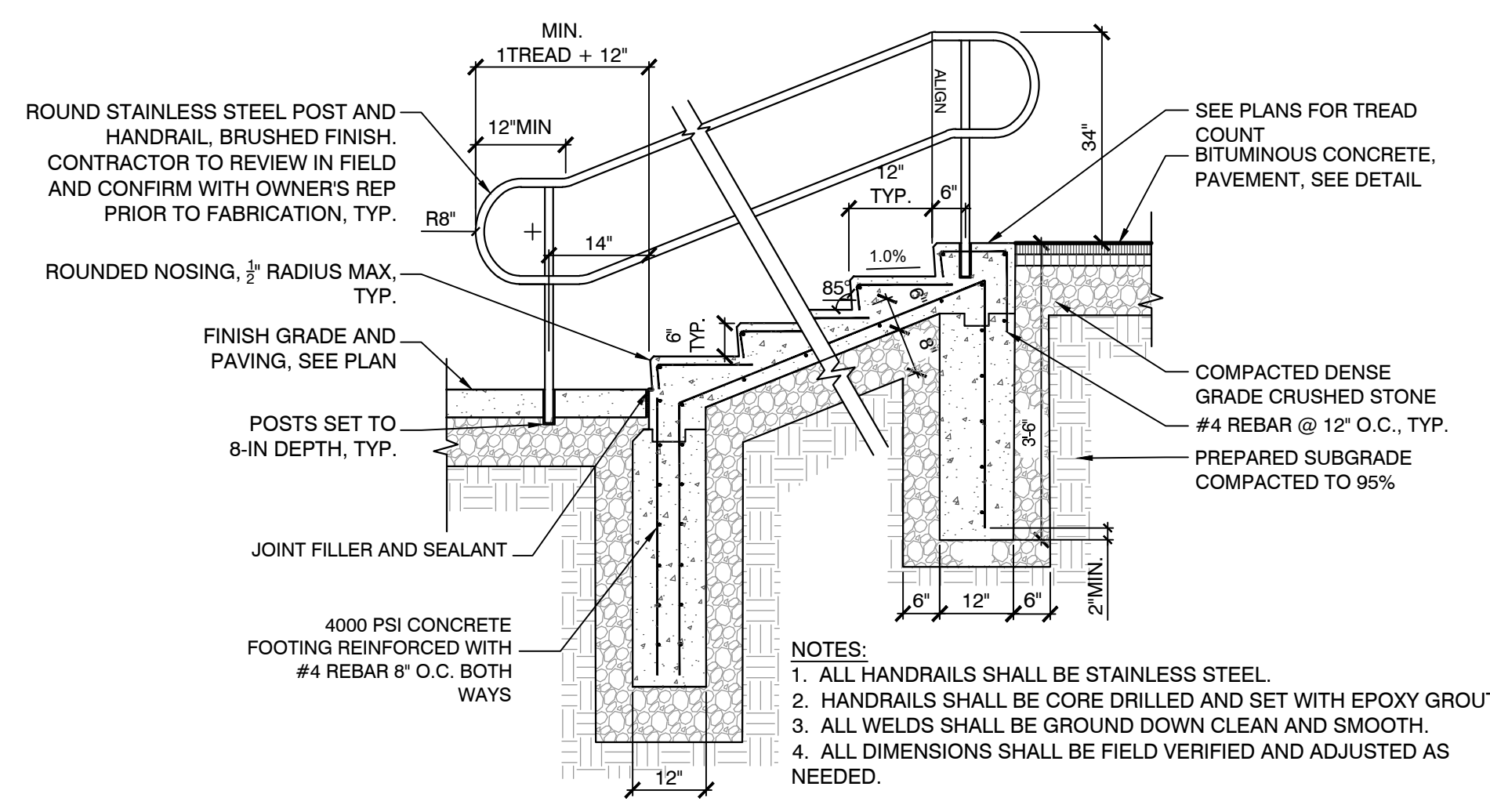

5 CONCRETE STAIR WITH STAINLESS STEEL HANDRAIL
SCALE: N.T.S.



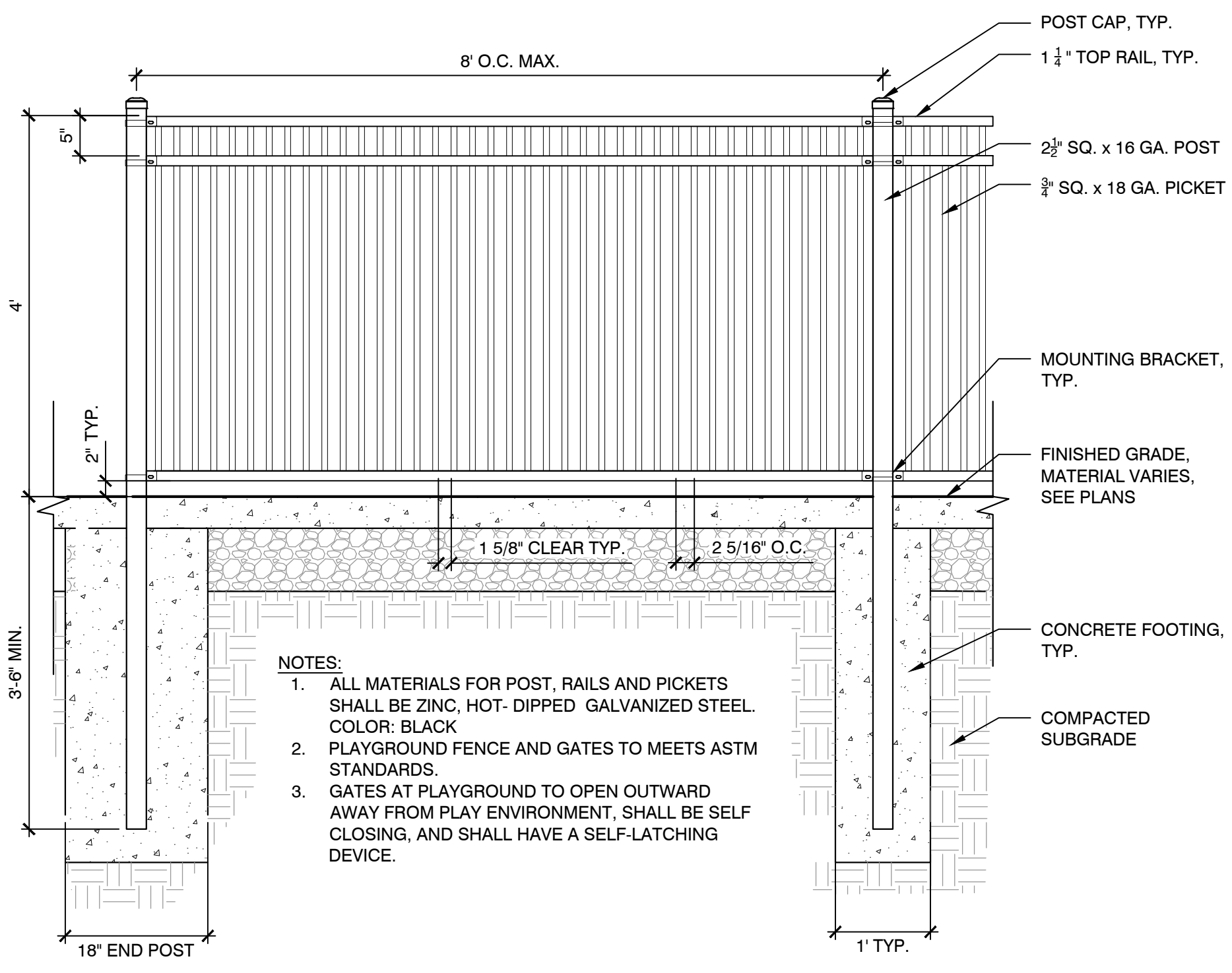

- NOTES:**
1. ALL MATERIALS FOR POST, RAILS AND PICKETS SHALL BE ZINC, HOT-DIPPED GALVANIZED STEEL. COLOR: BLACK
 2. PLAYGROUND FENCE AND GATES TO MEETS ASTM STANDARDS.
 3. GATES AT PLAYGROUND TO OPEN OUTWARD AWAY FROM PLAY ENVIRONMENT, SHALL BE SELF CLOSING, AND SHALL HAVE A SELF-LATCHING DEVICE.

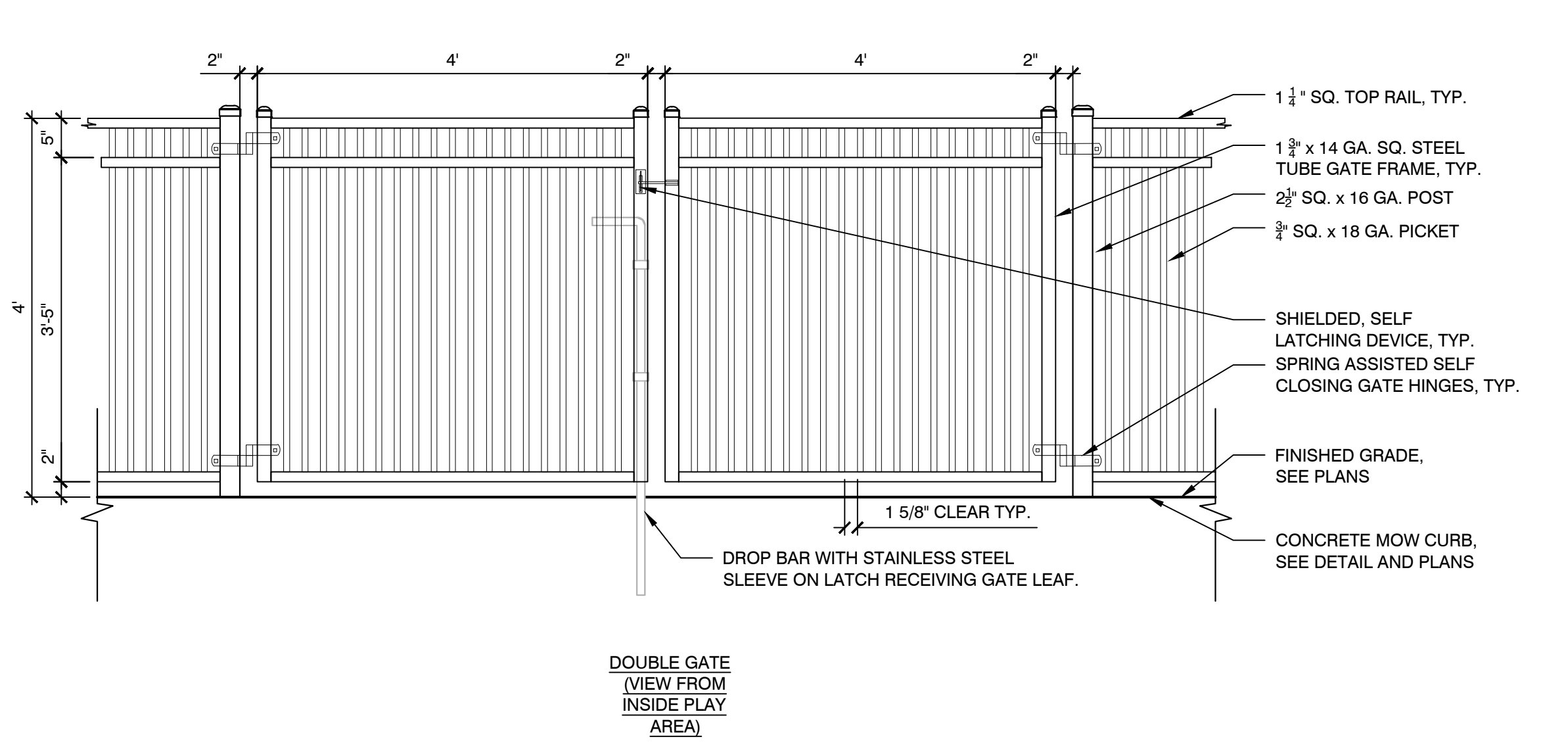
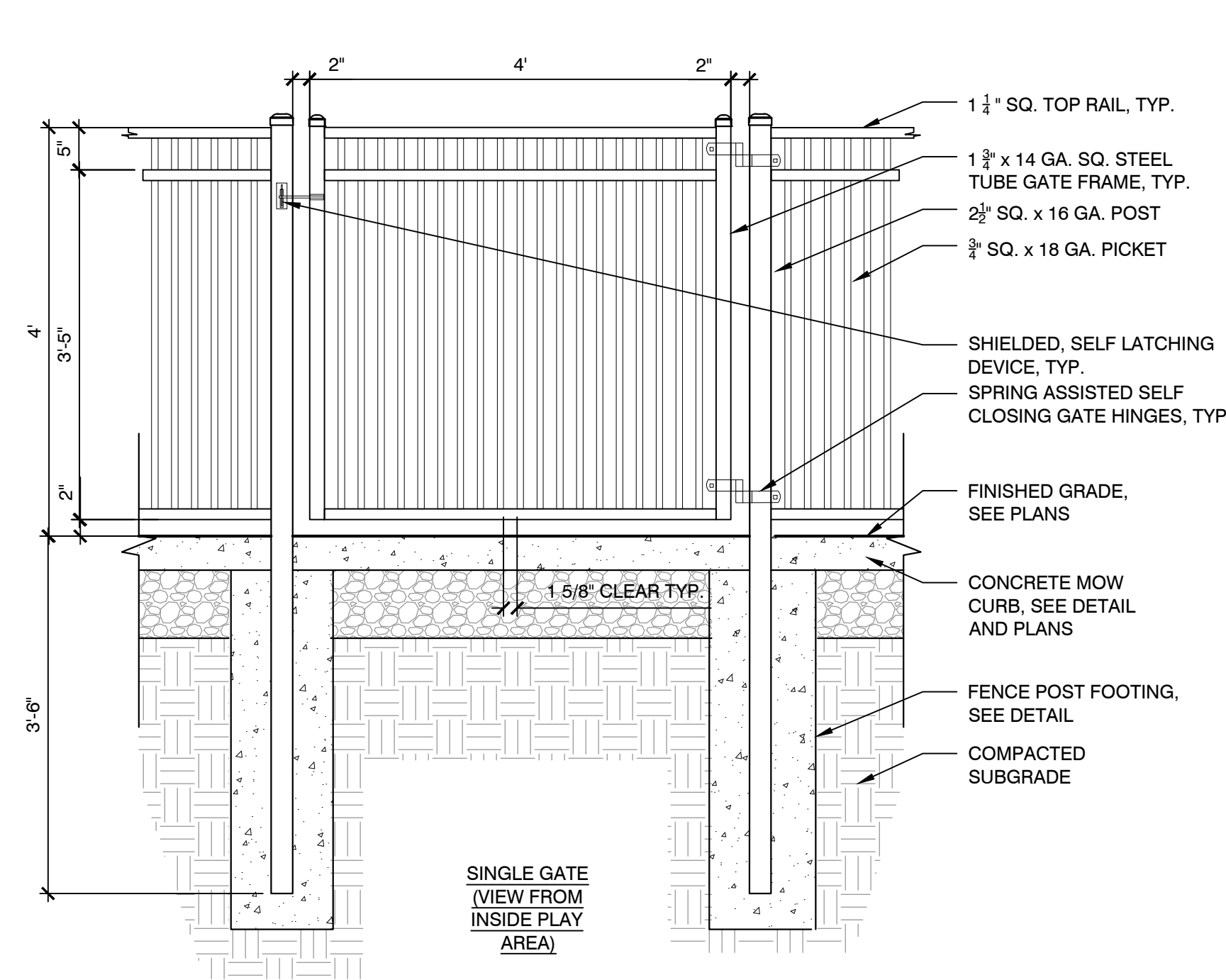

1 4' HT. METAL PICKET FENCE
SCALE: N.T.S.

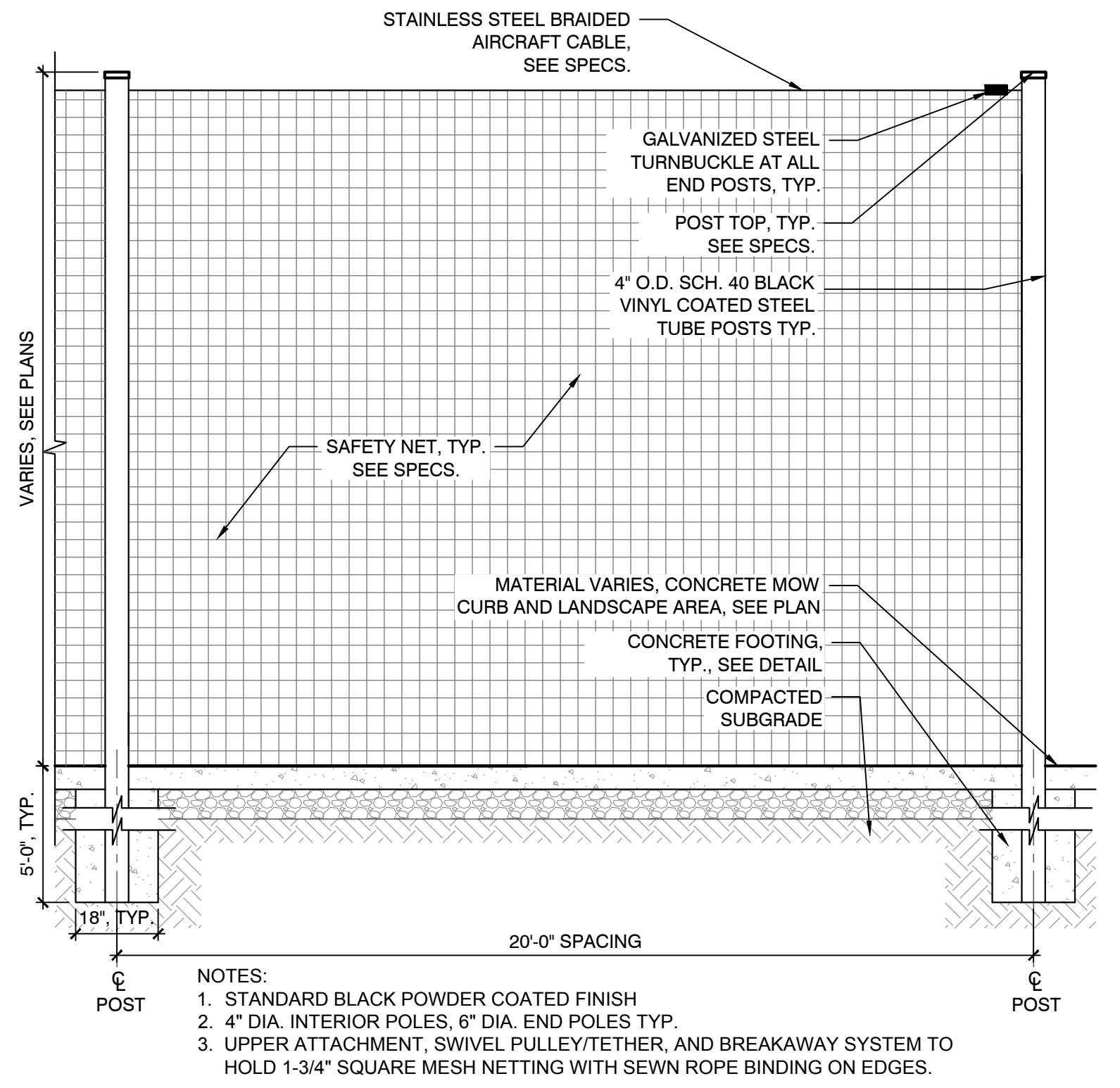

- NOTES:**
1. STANDARD BLACK POWDER COATED FINISH
 2. 4\"/>

2 SPORTS NETTING
SCALE: N.T.S.

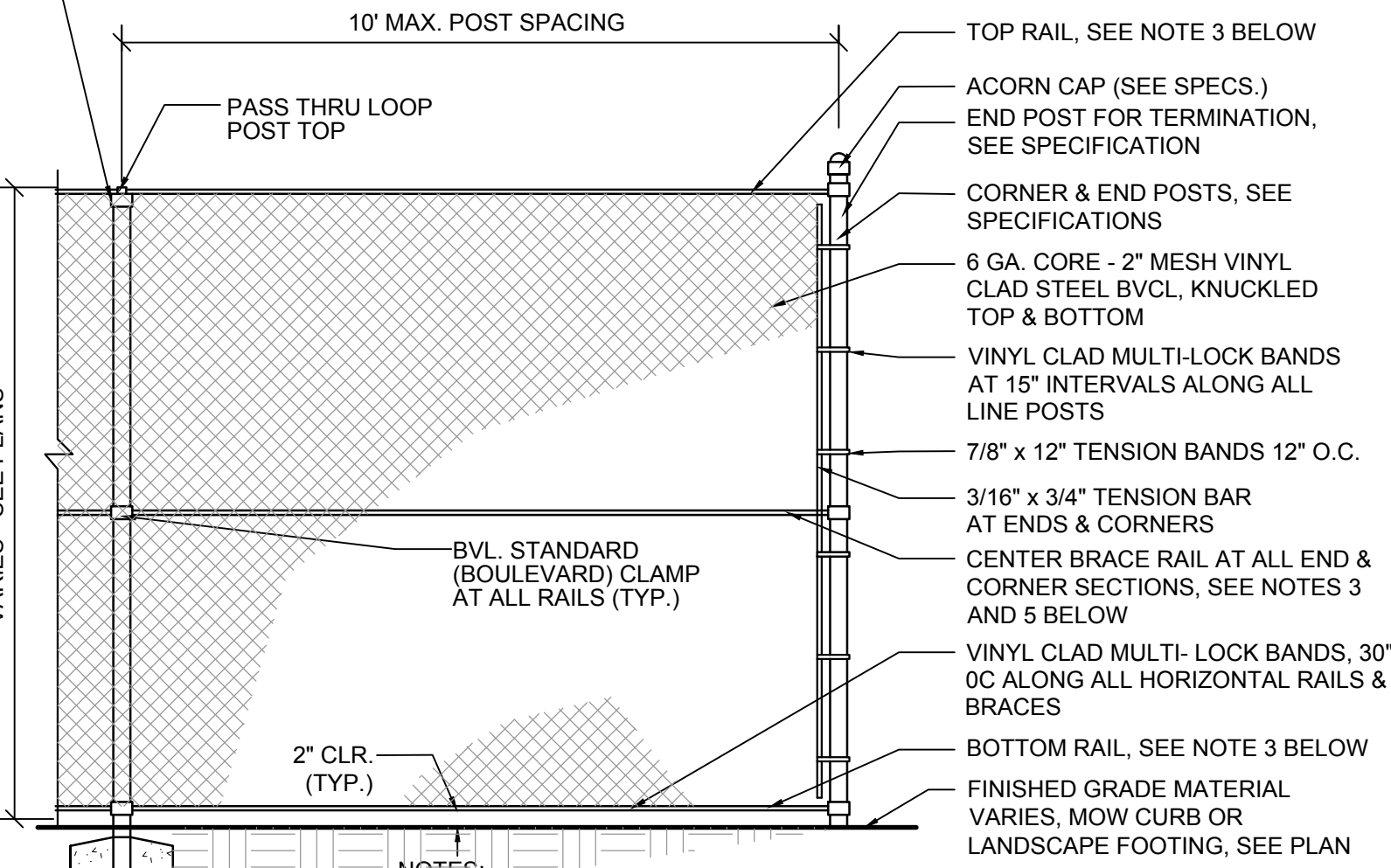
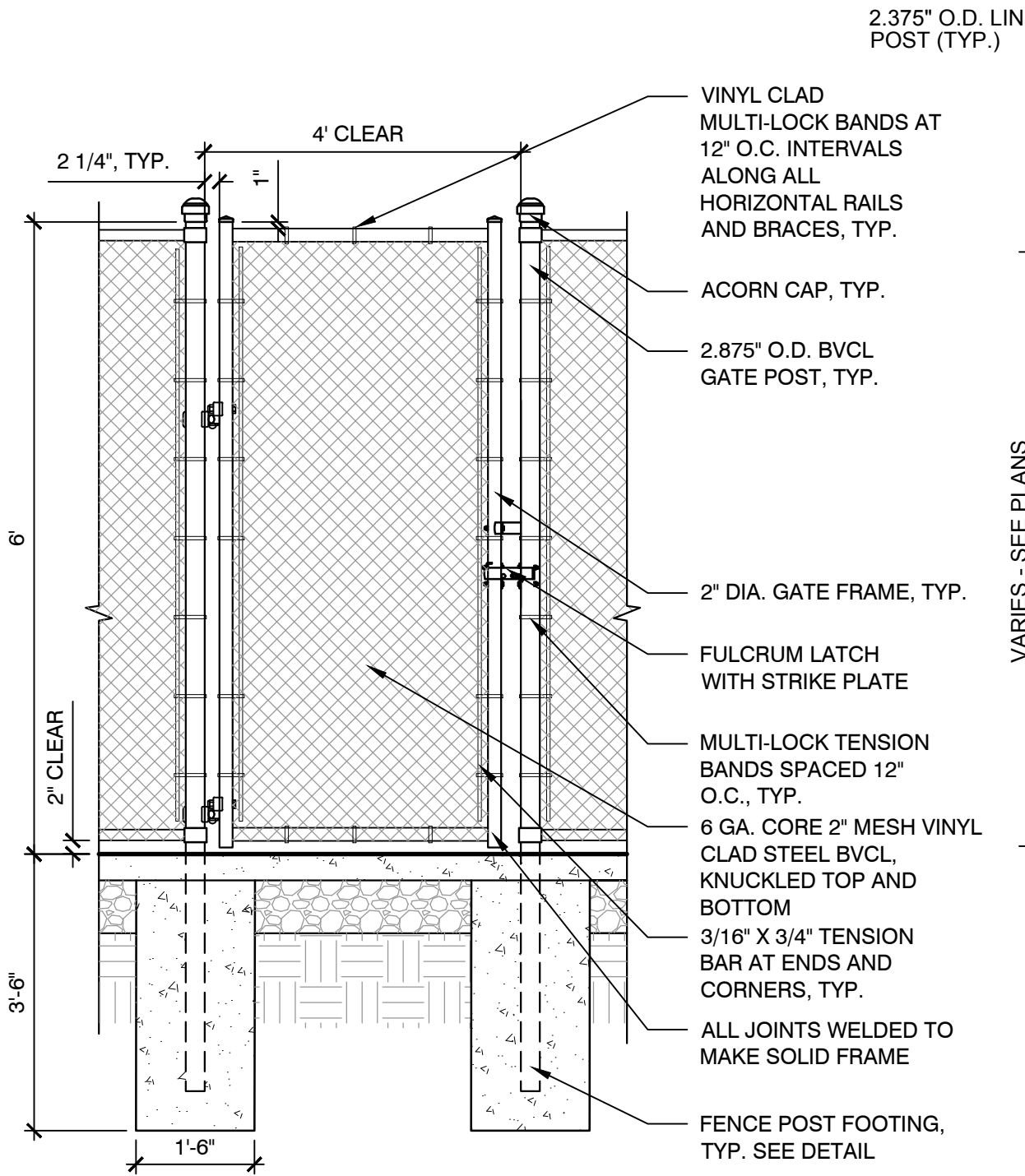

- NOTES:**
1. ALL FENCE PIPE SHALL BE SCH. 40, VINYL CLAD HOT DIP GALV. STEEL PIPE.
 2. ALL LINE POSTS SHALL BE INSTALLED EQUALLY SPACED BETWEEN END & CORNER POSTS.
 3. ALL RAILS SHALL BE 1.66\"/>

3 BVCL FENCE
SCALE: N.T.S.

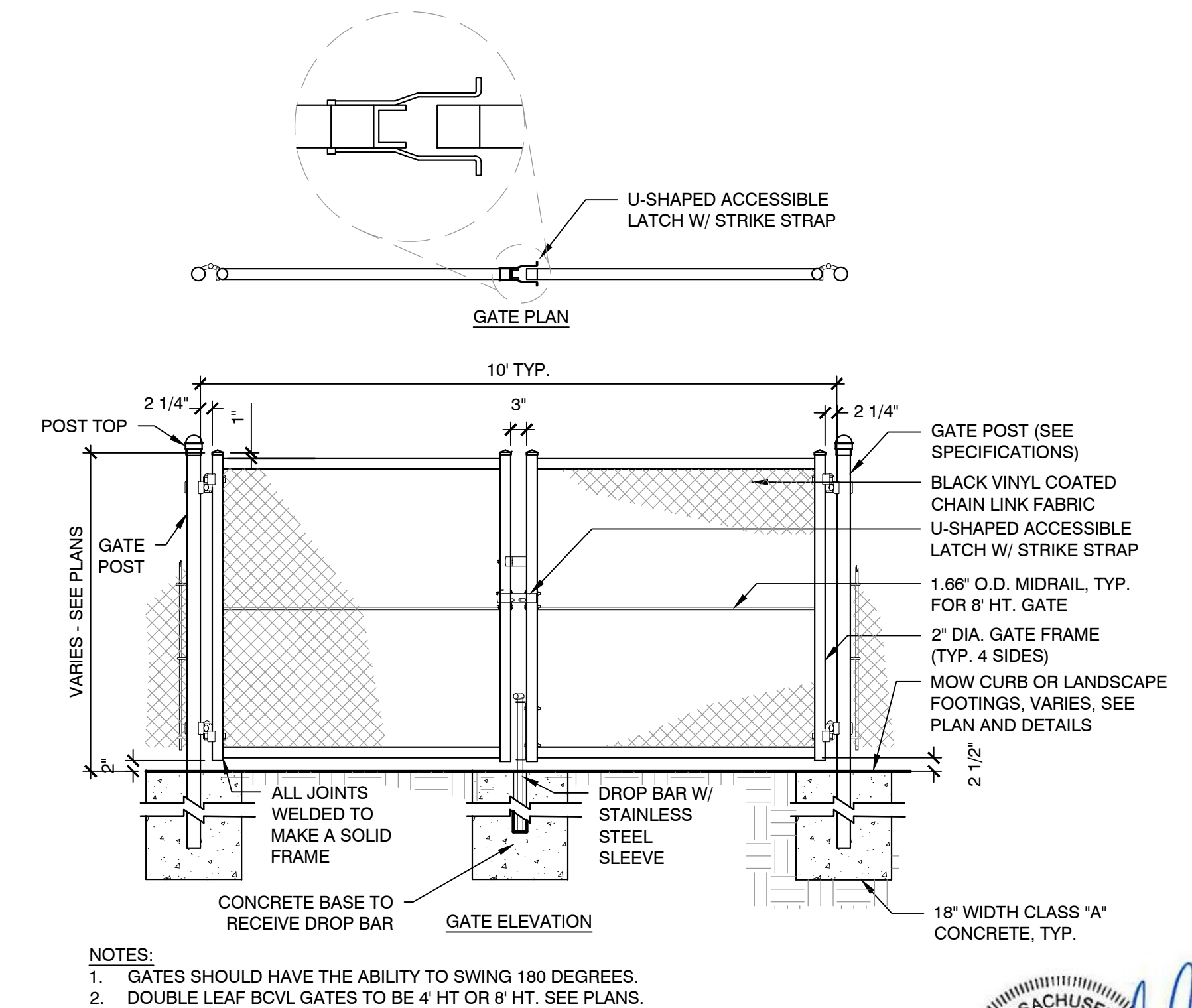

- NOTES:**
1. GATES SHOULD HAVE THE ABILITY TO SWING 180 DEGREES.
 2. DOUBLE LEAF BVCL GATES TO BE 4' HT OR 8' HT. SEE PLANS.

4 BVCL DOUBLE SWING GATE
SCALE: N.T.S.



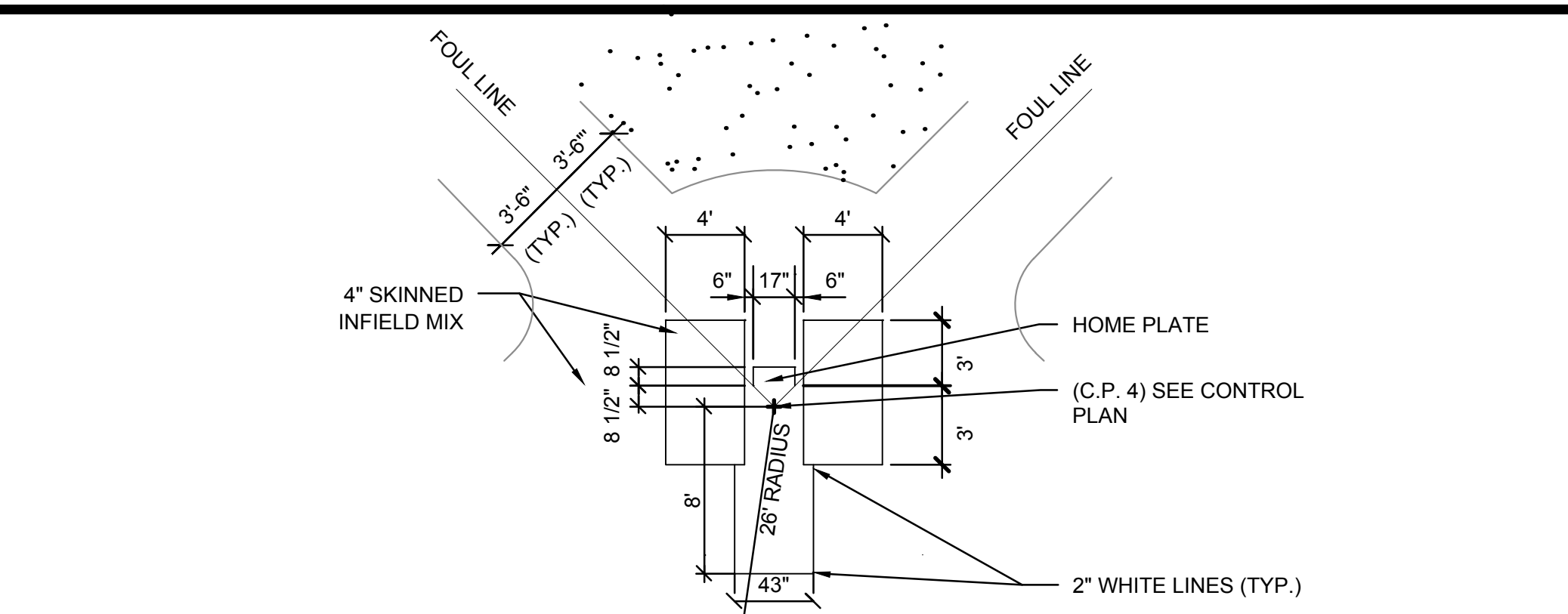
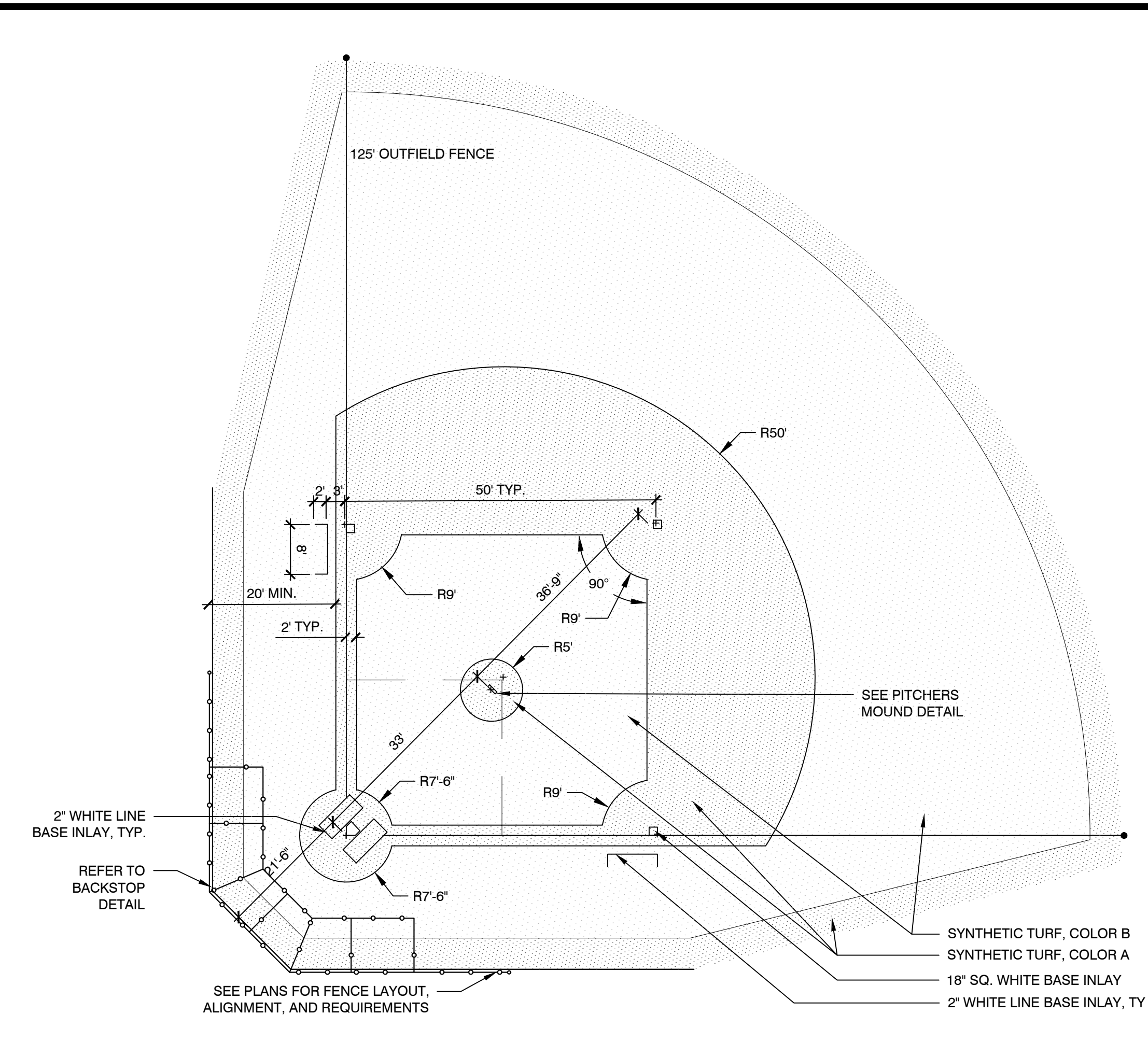
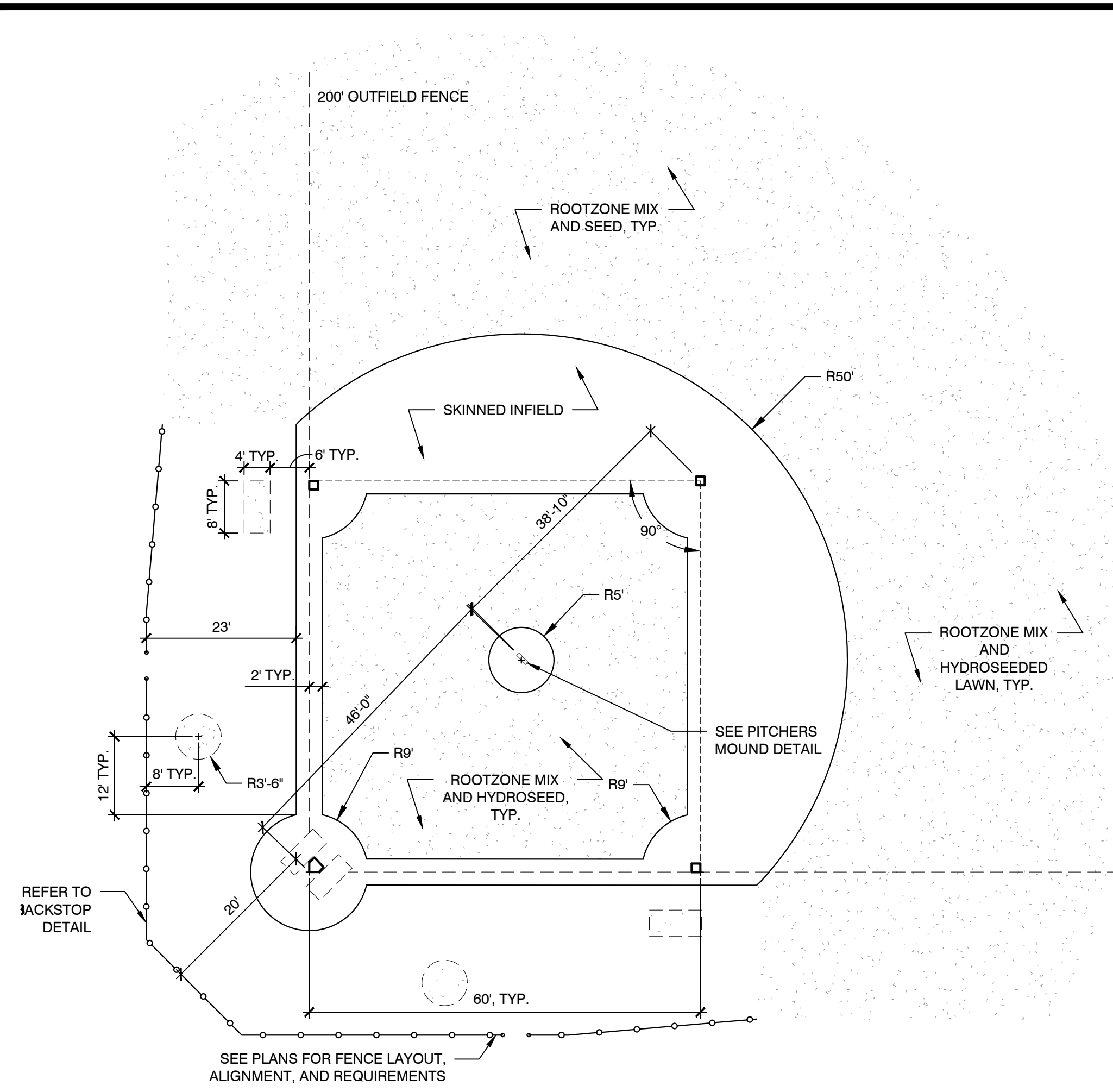

NOTES:
1. ALL DIMENSIONS ARE GIVEN TO OUTSIDE OF WHITE LINES

3 LITTLE LEAGUE HOME PLATE
SCALE: N.T.S.

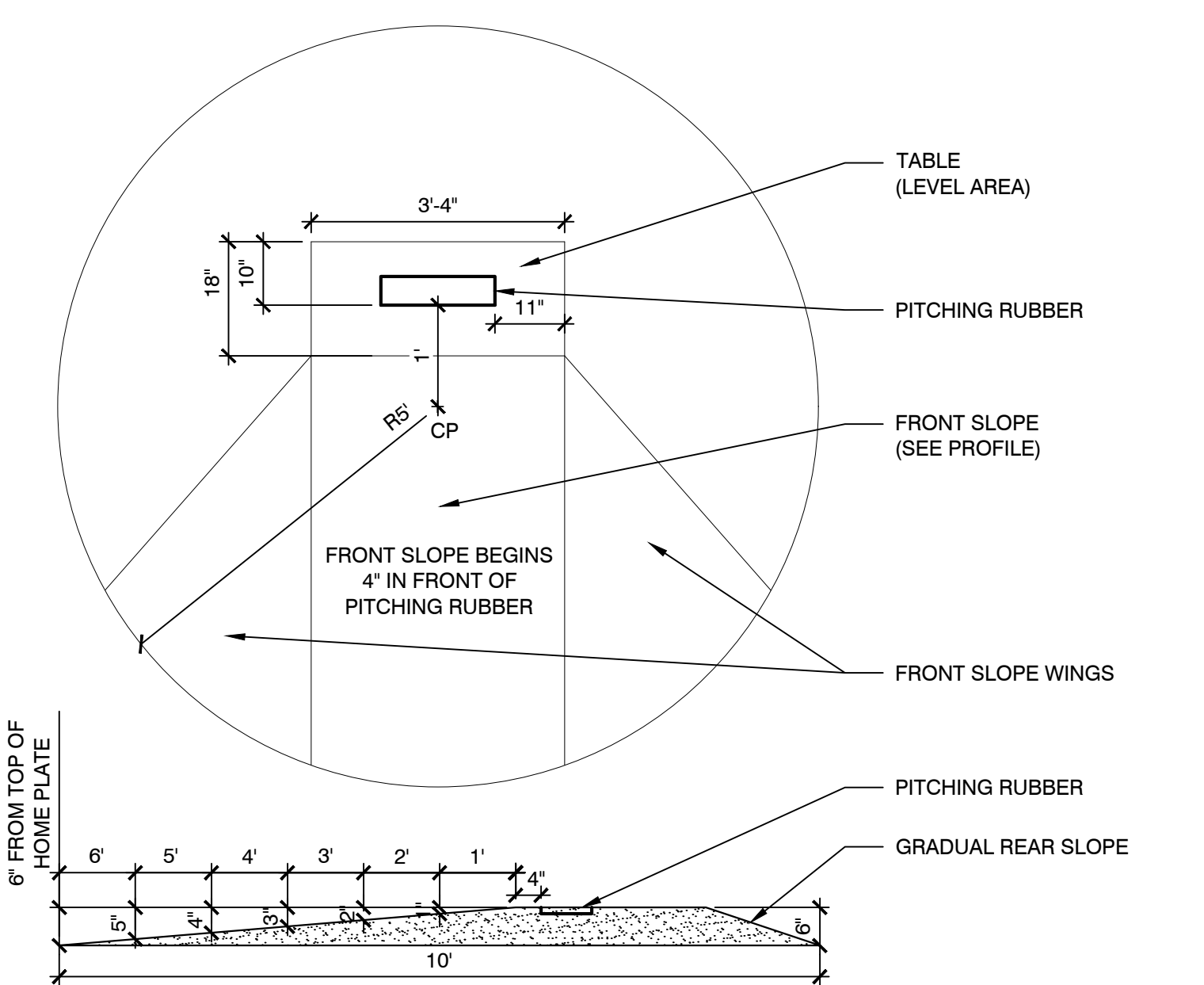

4 LITTLE LEAGUE PITCHERS MOUND
SCALE: N.T.S.

1 LITTLE LEAGUE FIELD LAYOUT
SCALE: N.T.S.

2 CHALLENGER FIELD LAYOUT
SCALE: N.T.S.

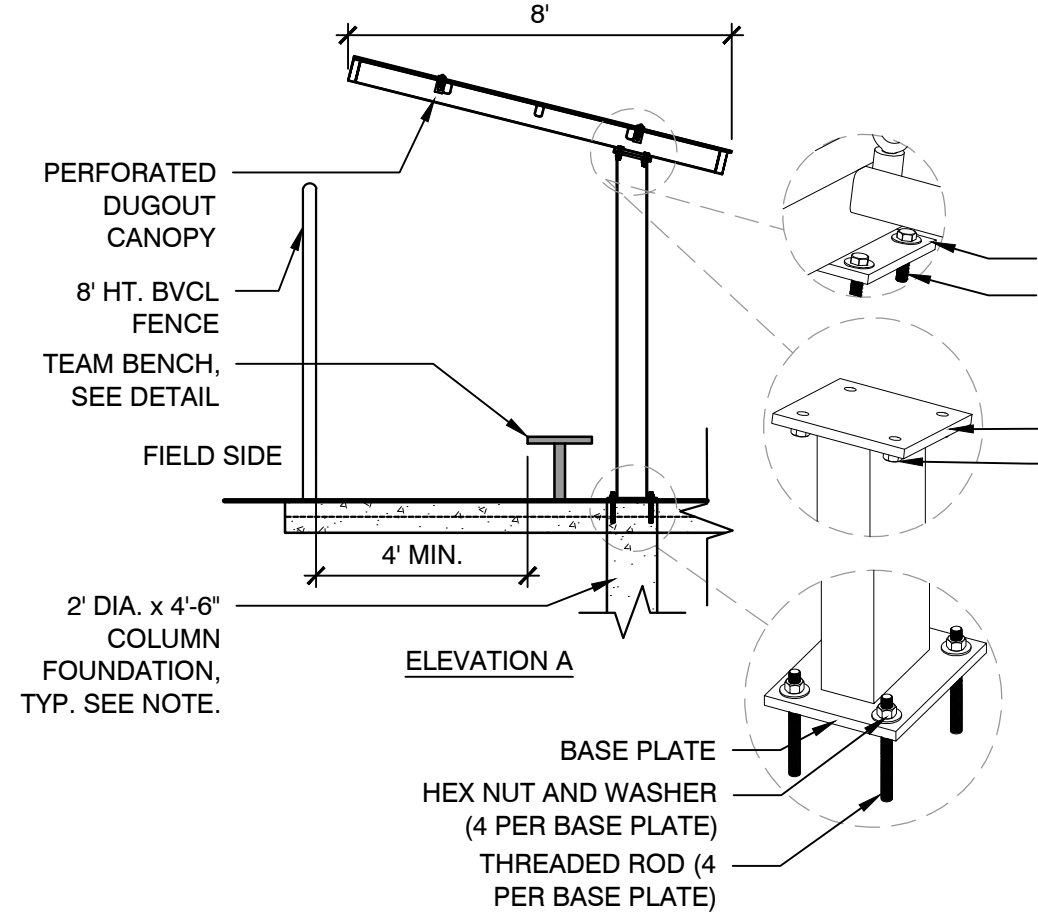
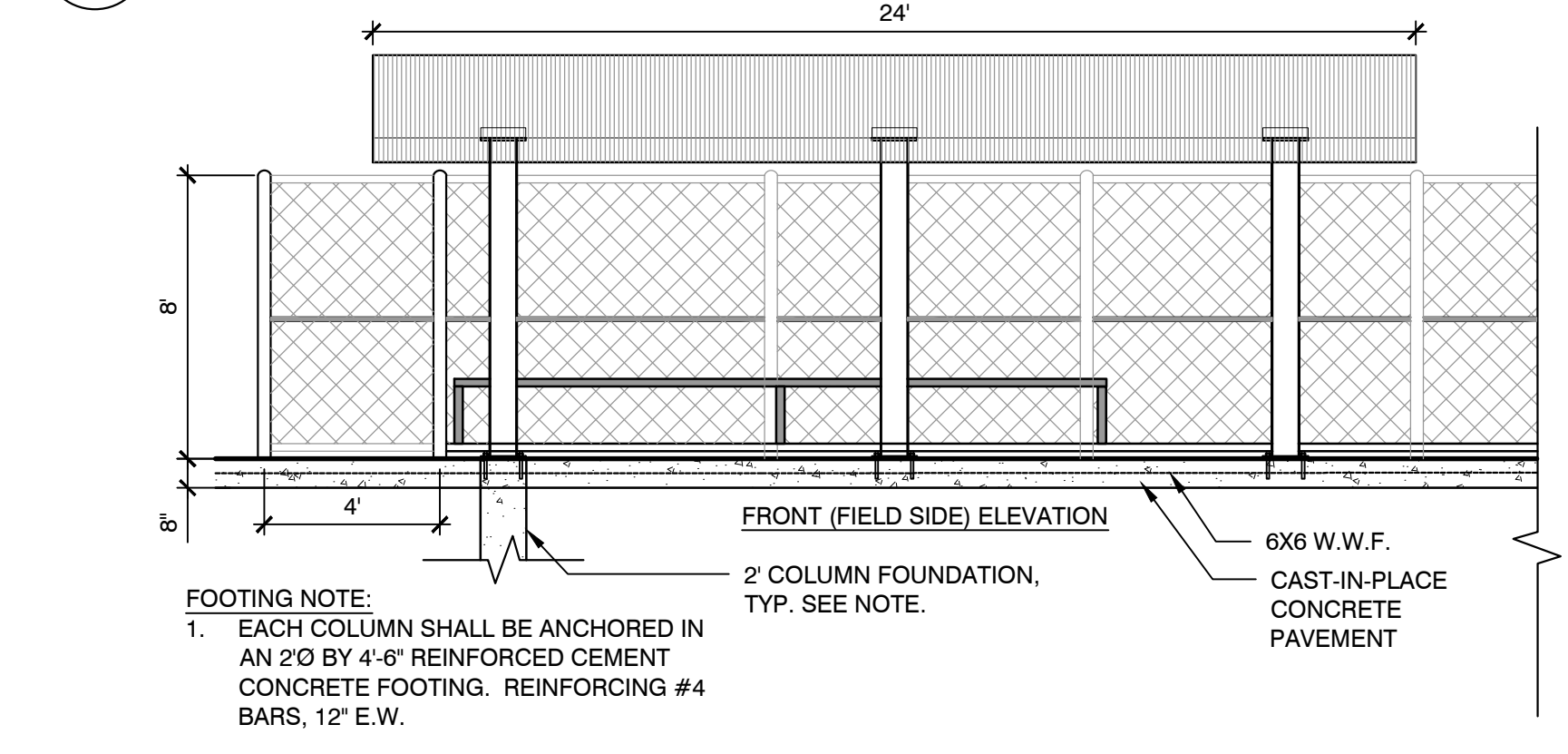
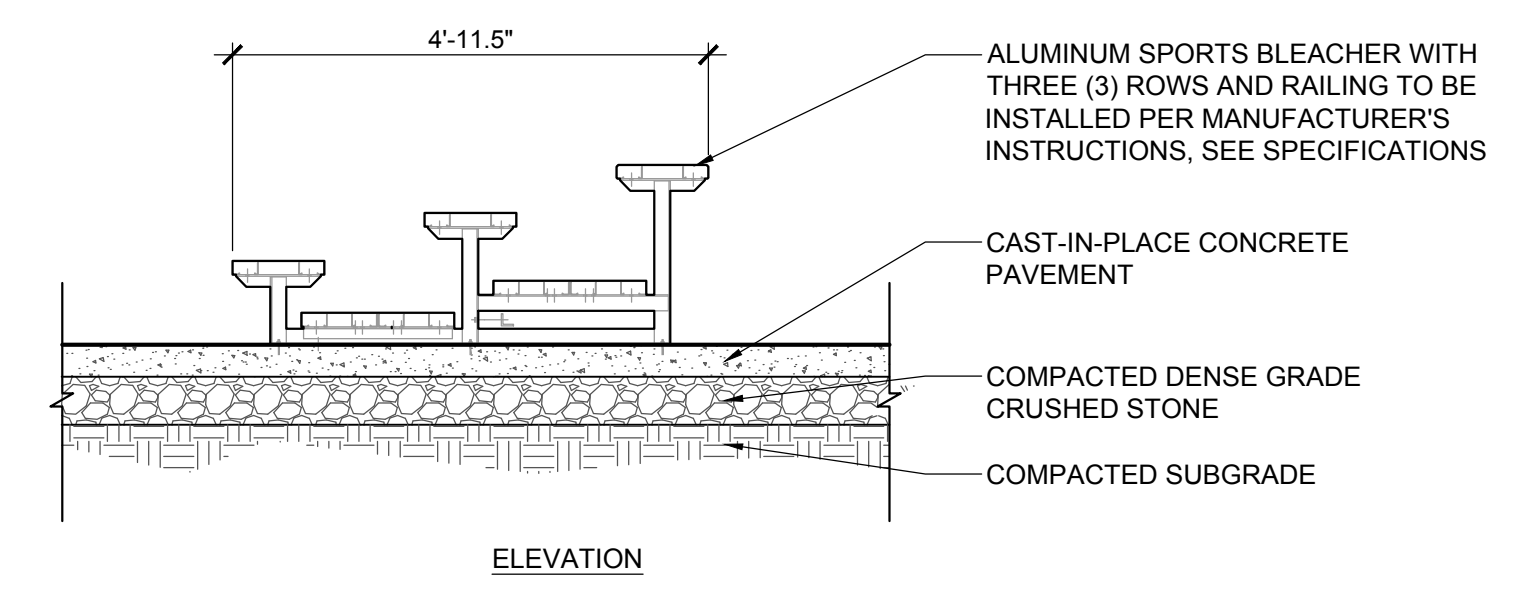

NOTES:
2. CANTILEVER DUGOUT TO BE 8' x 24' - SEE SPECIFICATIONS FOR MORE DETAIL
3. EACH COLUMN SHALL BE ANCHORED IN AN 2'0 BY 4'-6" REINFORCED CEMENT CONCRETE FOOTING. REINFORCING #4 BARS, 12" E.W.
4. CANOPY TO BE PERFORATED MATERIAL - COORDINATE WITH MANUFACTURER

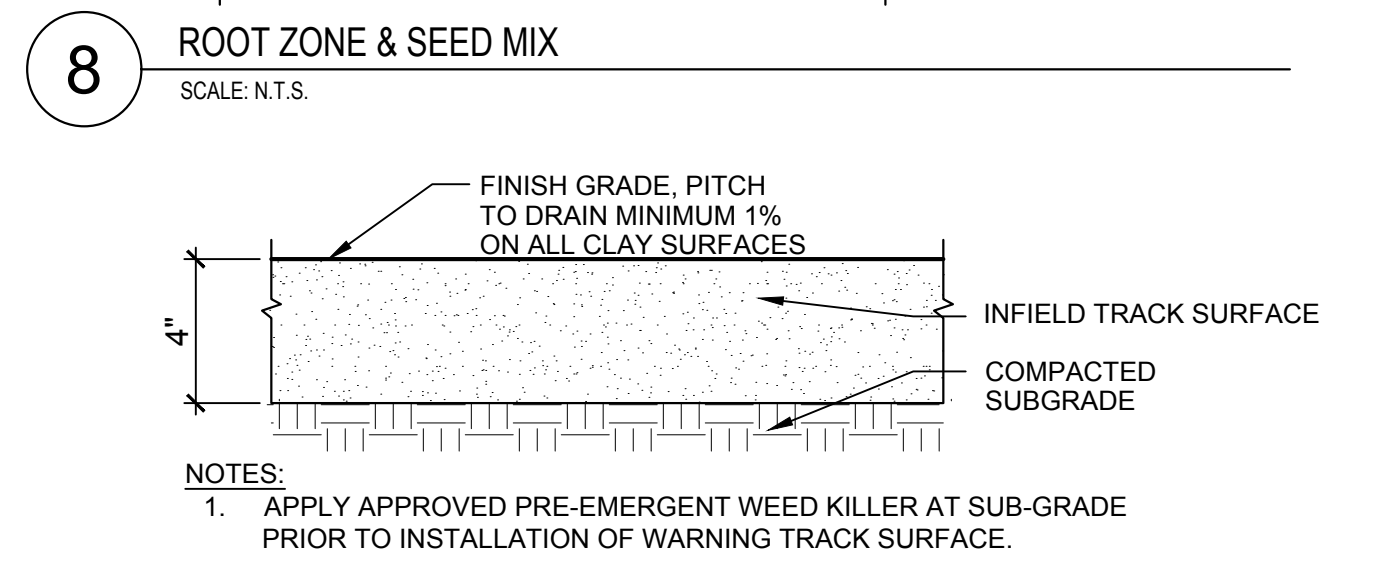
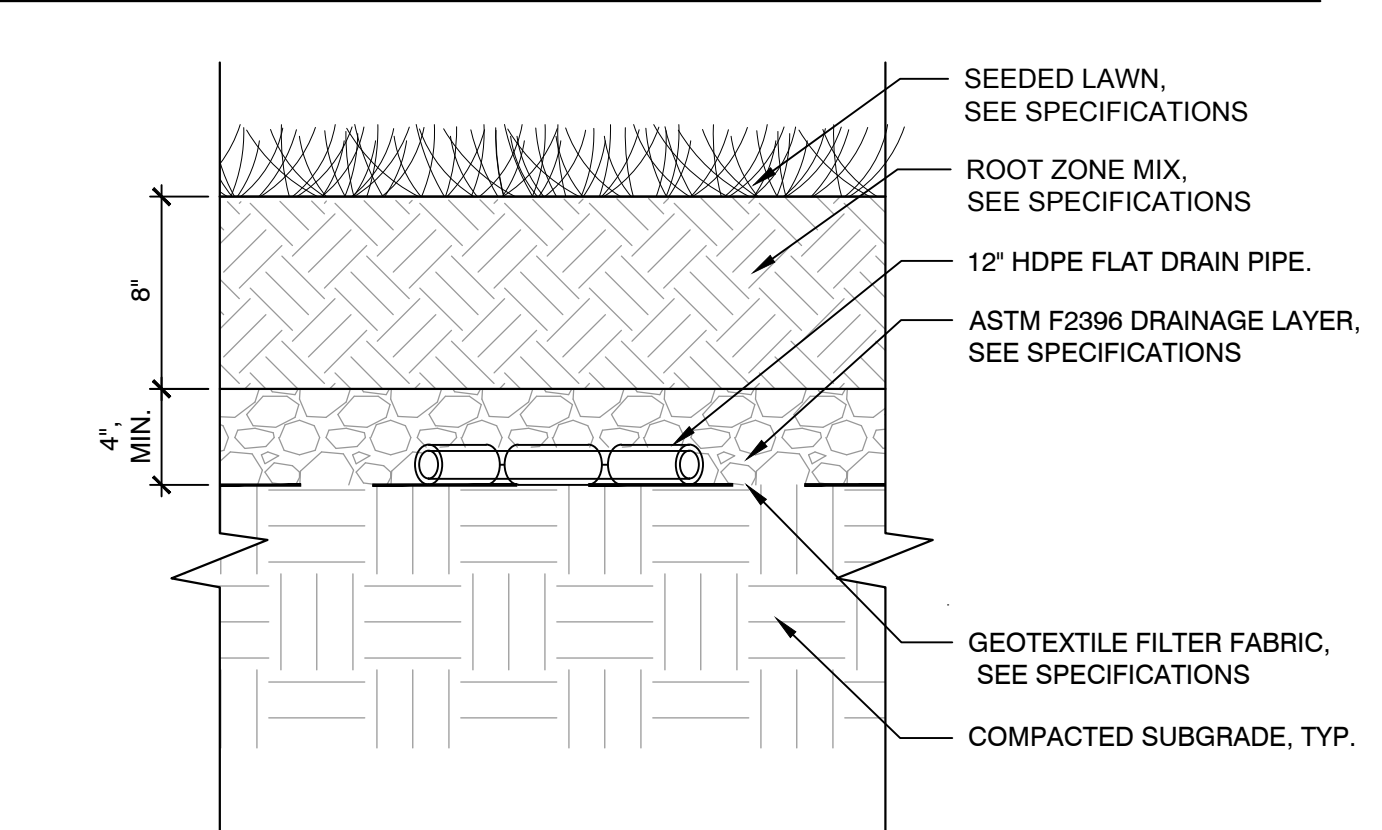

NOTES:
1. APPLY APPROVED PRE-EMERGENT WEED KILLER AT SUB-GRADE PRIOR TO INSTALLATION OF WARNING TRACK SURFACE.

5 SPECTATOR BLEACHER
SCALE: N.T.S.

6 TEAM BENCH
SCALE: N.T.S.

8 ROOT ZONE & SEED MIX
SCALE: N.T.S.

9 INFIELD AND WARNING TRACK MIX
SCALE: N.T.S.

6 TEAM BENCH
SCALE: N.T.S.

7 DUGOUT STRUCTURE
SCALE: N.T.S.



Prepared By:
Weston & Sampson
Consultant Project No. 2160850

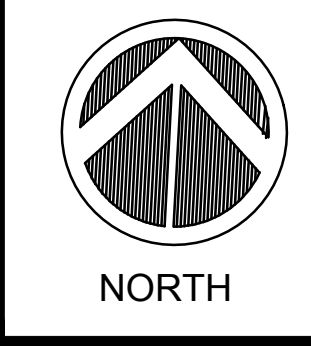

No.	Date	Revision

Approved By: _____ Date: _____

Project Name: **IMPROVEMENTS TO McCONNELL PARK**

BWSC SUBMISSION
Date: FEBRUARY 2021
Scale: _____
Drawn: ENB, LSR
Checked: CFR

Sheet Name: **CONSTRUCTION DETAILS**

SHEET: **L7.11**

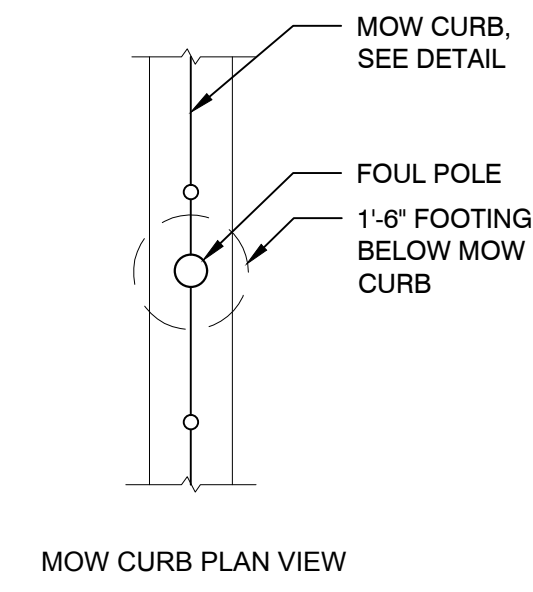
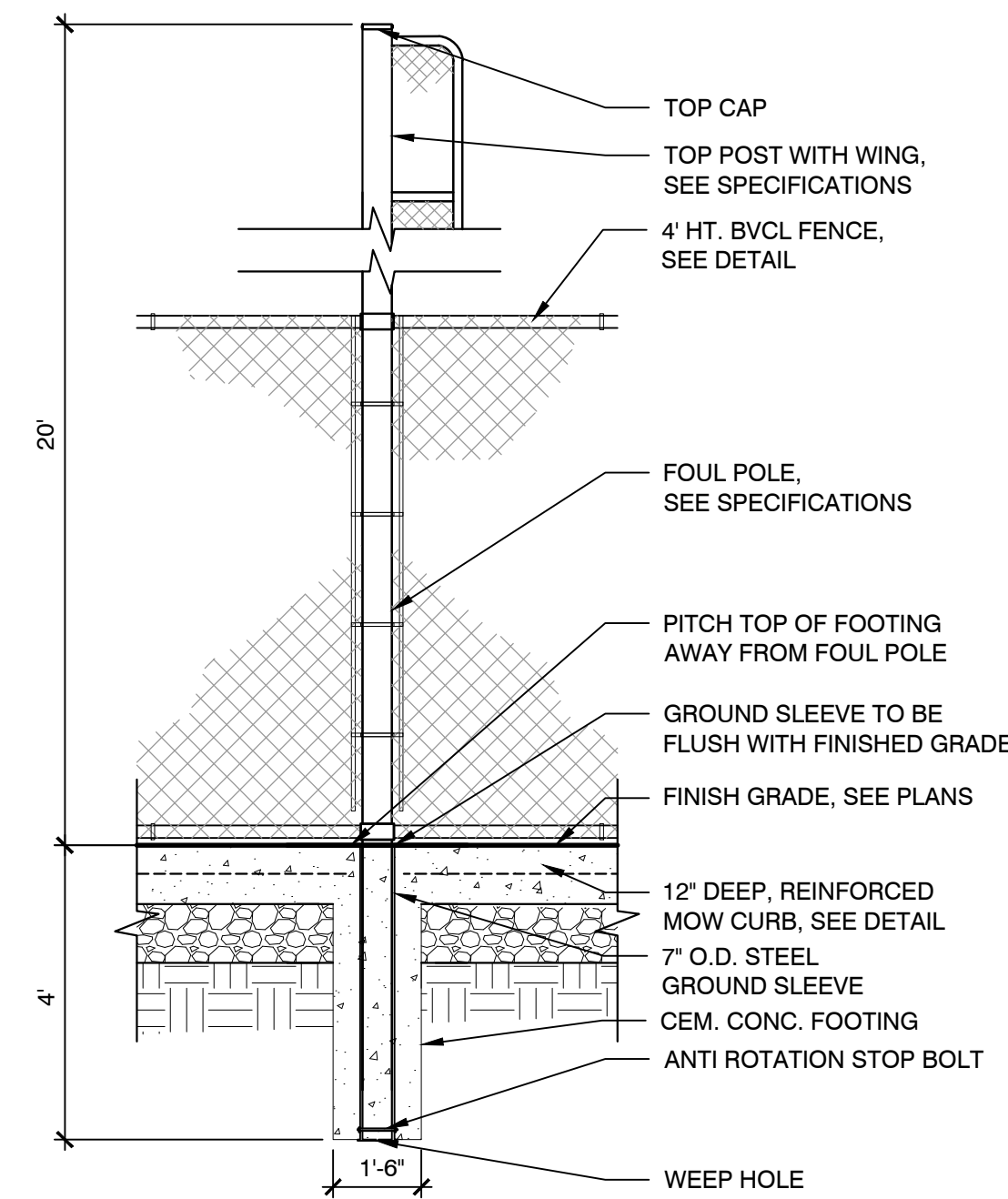

NOTES:
 1. CONTRACTOR SHALL PROVIDE GROUND SLEEVE CAP BY MANUFACTURER.
 2. ANTI-ROTATION STOP BOLT SHALL BE 1.2" X 8" LONG HEX BOLT AND ANTI-ROTATION STOP MUST BE PARALLEL WITH SLOT AT BOTTOM OF FOUL POLE.

1 FOUL POLE AT FENCE
 SCALE: N.T.S.

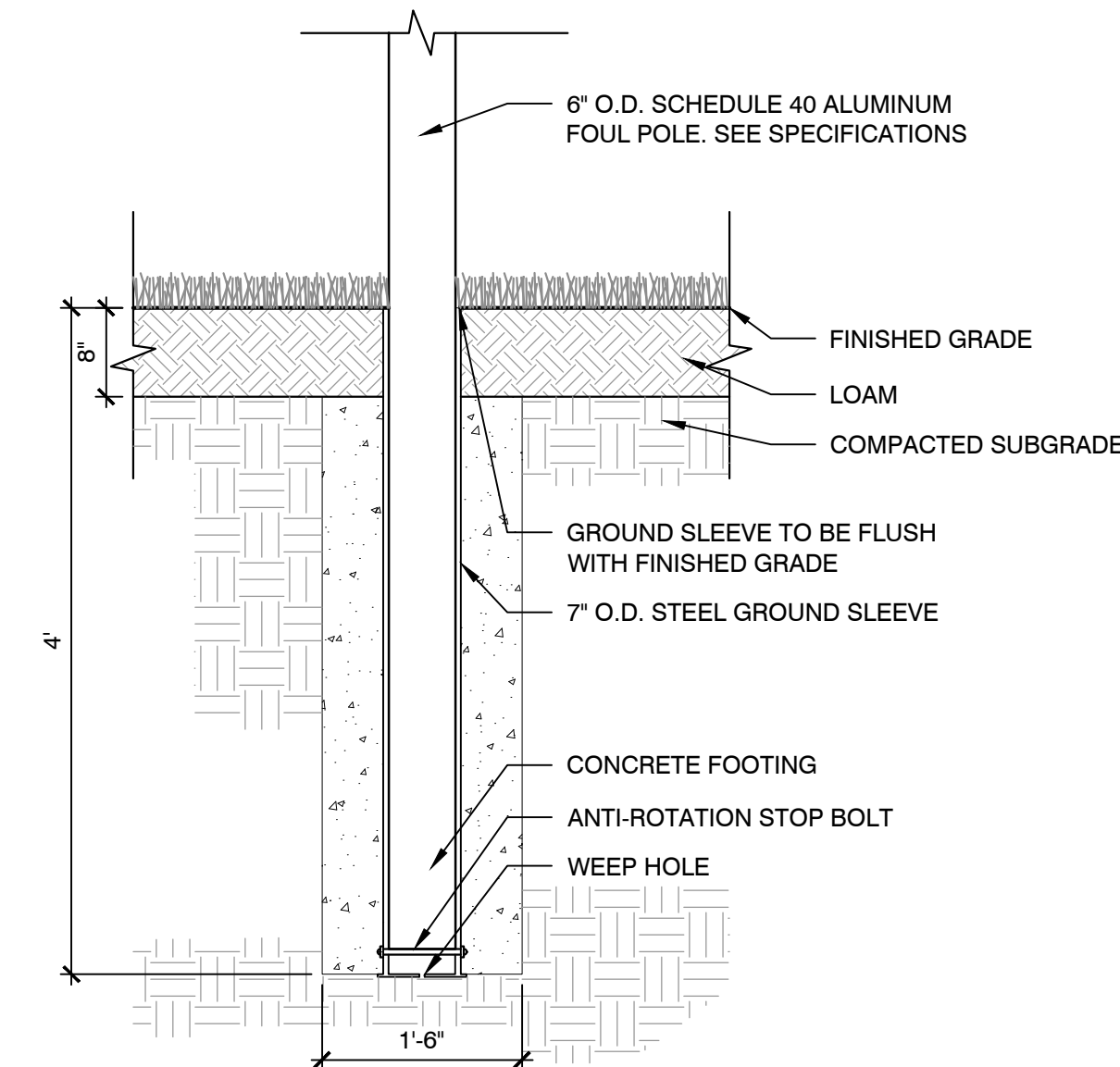

NOTES:
 1. CONTRACTOR SHALL PROVIDE GROUND SLEEVE CAP BY MANUFACTURER.
 2. ANTI-ROTATION STOP BOLT SHALL BE 1.2" X 8" LONG HEX BOLT AND ANTI-ROTATION STOP MUST BE PARALLEL WITH SLOT AT BOTTOM OF FOUL POLE.

2 FOUL POLE IN LANDSCAPE FOOTING
 SCALE: N.T.S.

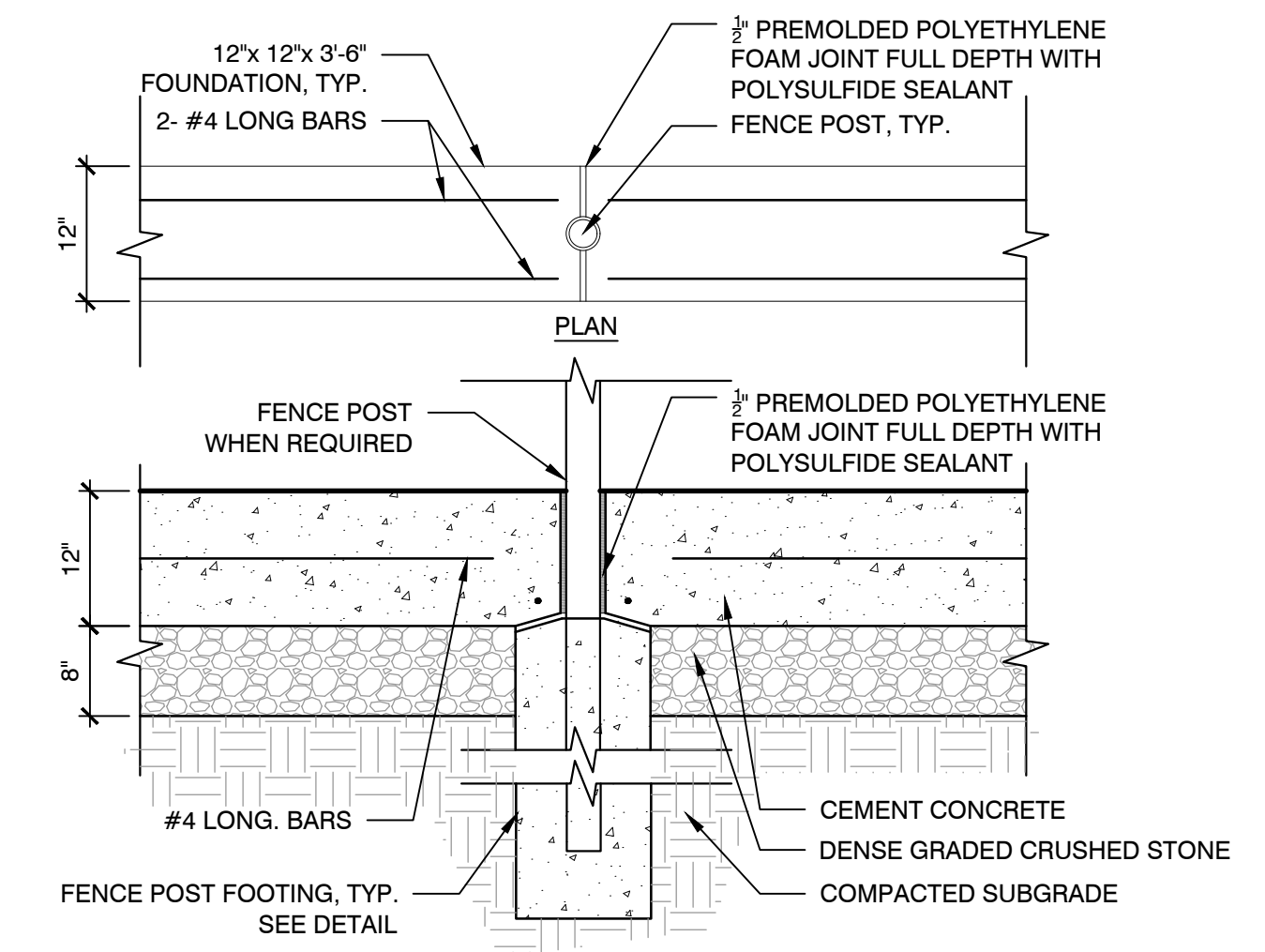

NOTES:
 1. MOW STRIP CORNERS ADJACENT TO RESILIENT SURFACING SHALL BE SQUARE TO ENSURE SMOOTH INTERFACE BETWEEN MATERIALS.
 2. MOW STRIP CORNERS ADJACENT TO PLANTING BED OR LAWN AREAS WILL HAVE 3/8" CHAMFER.
 3. CONTRACTOR SHALL PROVIDE 3/8" PREMOLDED POLYETHYLENE FOAM EXPANSION JOINT, FULL DEPTH WITH SILICONE SEALANT EVERY 30' O.C. UNLESS OTHERWISE NOTED.
 4. CONTRACTOR SHALL USE EXTREME CAUTION AT ROOT ZONE OF EXISTING TREES TO REMAIN. CONTRACTOR SHALL CLEAN CUT ANY ROOTS OVER 2" DIA. THAT ARE EFFECTED BY THE SCOPE OF WORK. CONTRACTOR SHALL CONSULT ARBORIST PRIOR TO ANY ROOT REMOVAL.

3 CONCRETE MOW CURB AT FENCE
 SCALE: N.T.S.

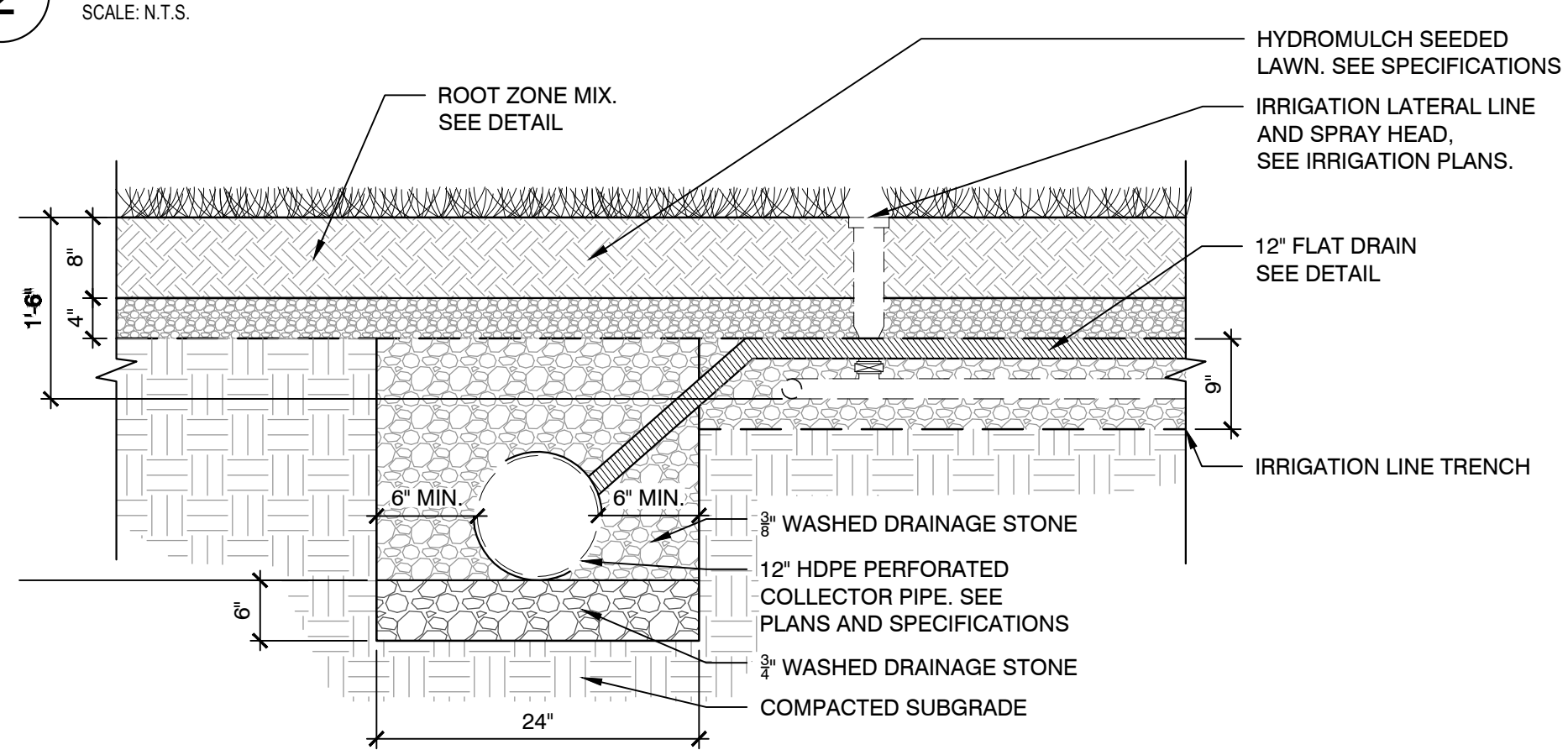

4 LATERAL COLLECTOR DRAIN AT NATURAL TURF FIELD
 SCALE: N.T.S.

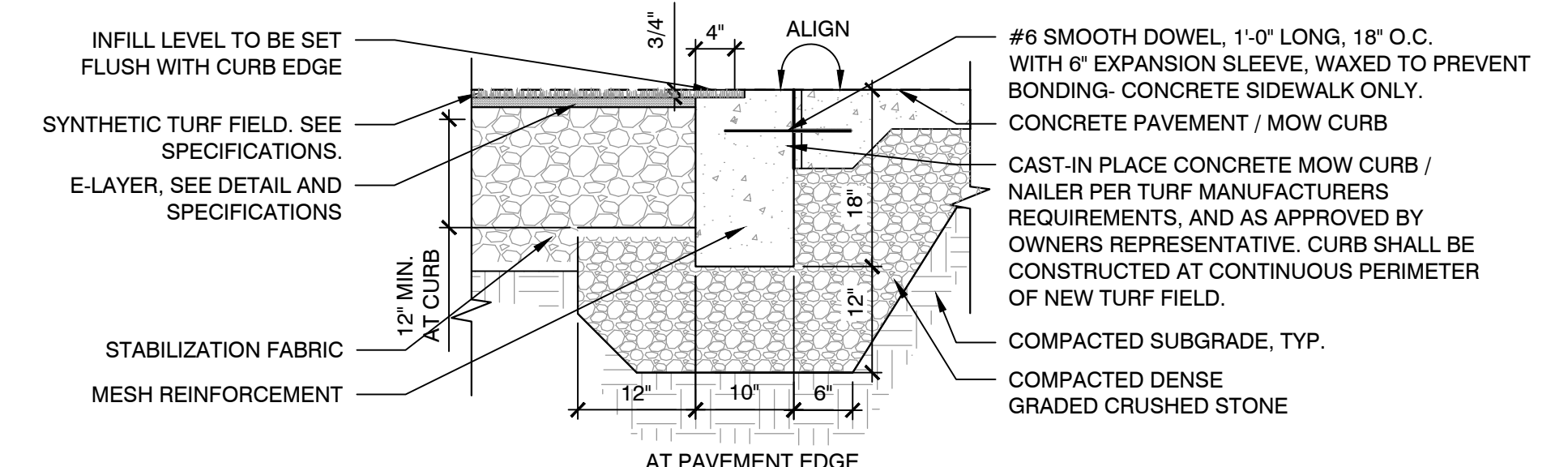

NOTES:
 1. CONTRACTOR TO PROVIDE CONTROL JOINTS (PREFORMED OR SAWCUT) 10' O.C. MIN. 1/2" DEEP.
 2. CONTRACTOR TO PROVIDE EXPANSION JOINTS EVERY 40' O.C.
 3. CONCRETE CURB TO BE 4,500 PSI AT 28 DAYS (AIR CONTENT 6% +/- 1%) (COARSE AGGREGATE ASTM C-33 SIZE #57)

5 SYNTHETIC TURF MOW CURB AND NAILER
 SCALE: N.T.S.

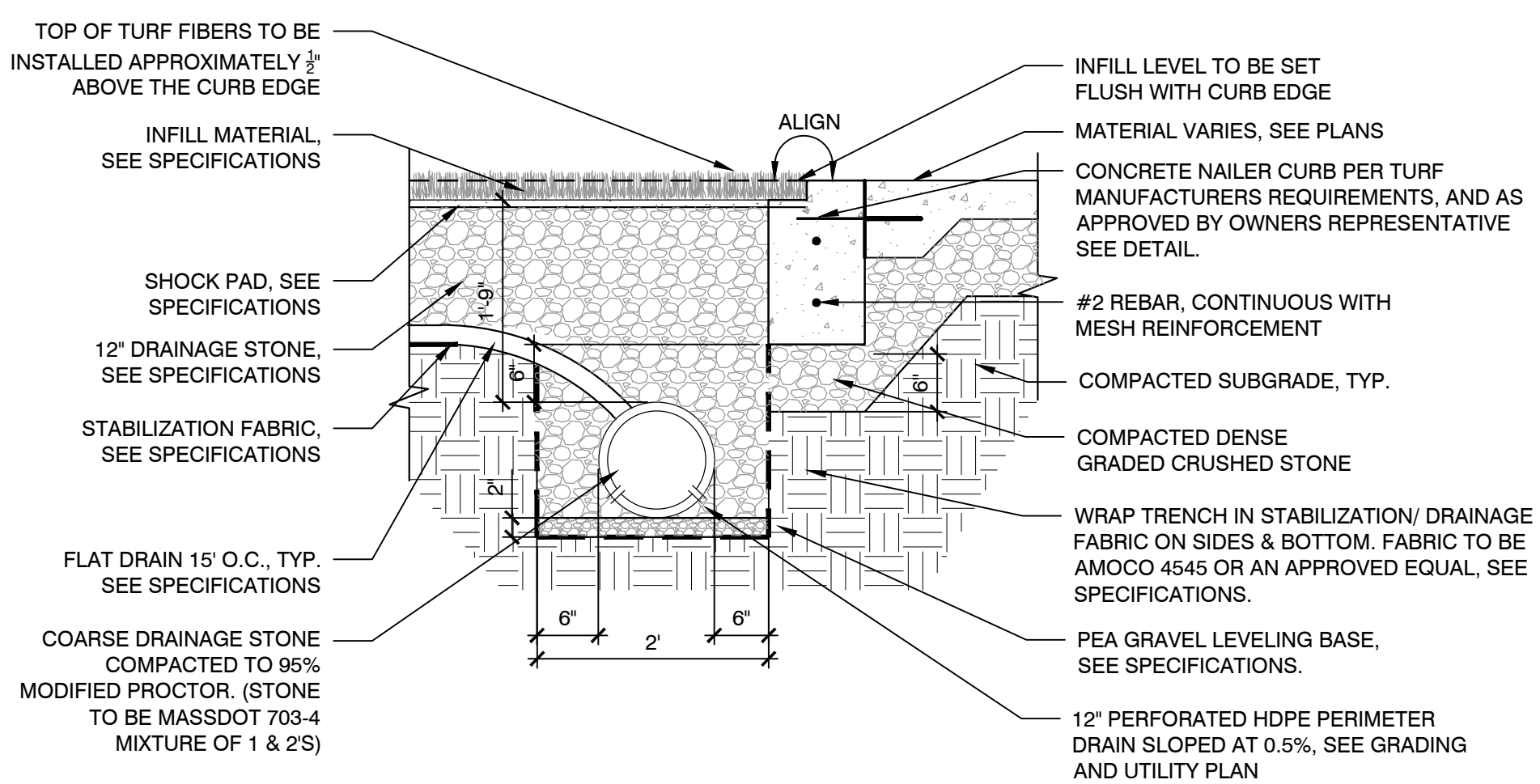

NOTES:
 1. FLAT DRAIN TO BE DIRECTLY CONNECTED TO PERIMETER DRAIN. PROVIDE MANUFACTURED FITTINGS TO MAKE THE CONNECTION AS REQUIRED AND APPROVED BY THE OWNER'S REPRESENTATIVE.
 2. CONCRETE NAILER CURB TO BE 4,500 PSI AT 28 DAYS (AIR CONTENT 6% +/- 1%) (COARSE AGGREGATE ASTM C-33 SIZE #57)

6 COLLECTOR DRAIN AT SYNTHETIC TURF FIELD
 SCALE: N.T.S.

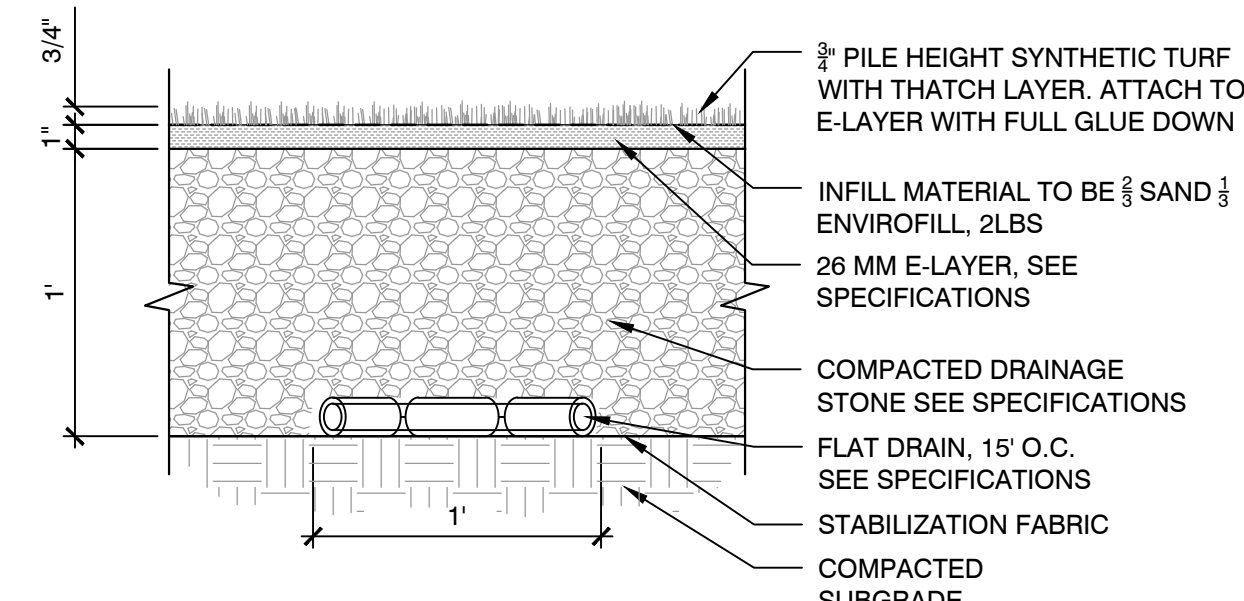

NOTES:
 1. SUBGRADE ELEVATIONS TO FOLLOW SAME SLOPE AS FINISHED SURFACE ELEVATIONS WITHIN TURF LIMITS.
 2. ABSOLUTELY NO SUBSTITUTIONS SHALL BE ALLOWED FOR BOTH THE STONE LEVELING COURSE AND DRAINAGE STONE WITHOUT A WRITTEN AND SIGNED DOCUMENT DIRECTLY FROM THE TURF MANUFACTURER. DOCUMENT SHALL STATE: THE MATERIAL IS AN ACCEPTABLE MATERIAL TO BE USED DIRECTLY UNDER THEIR TURF FIELD FABRIC AND THAT THE SUBSTITUTION MATERIAL PROVIDES THE SAME CHARACTERISTICS (DRAINAGE, STRUCTURAL INTEGRITY, PLAYABILITY, ETC.) AS THE MATERIALS SPECIFIED. FAILURE TO PROVIDE SUCH A DOCUMENT SHALL BE AT THE RISK AND COST OF THE CONTRACTOR.

7 SYNTHETIC TURF SURFACING
 SCALE: N.T.S.

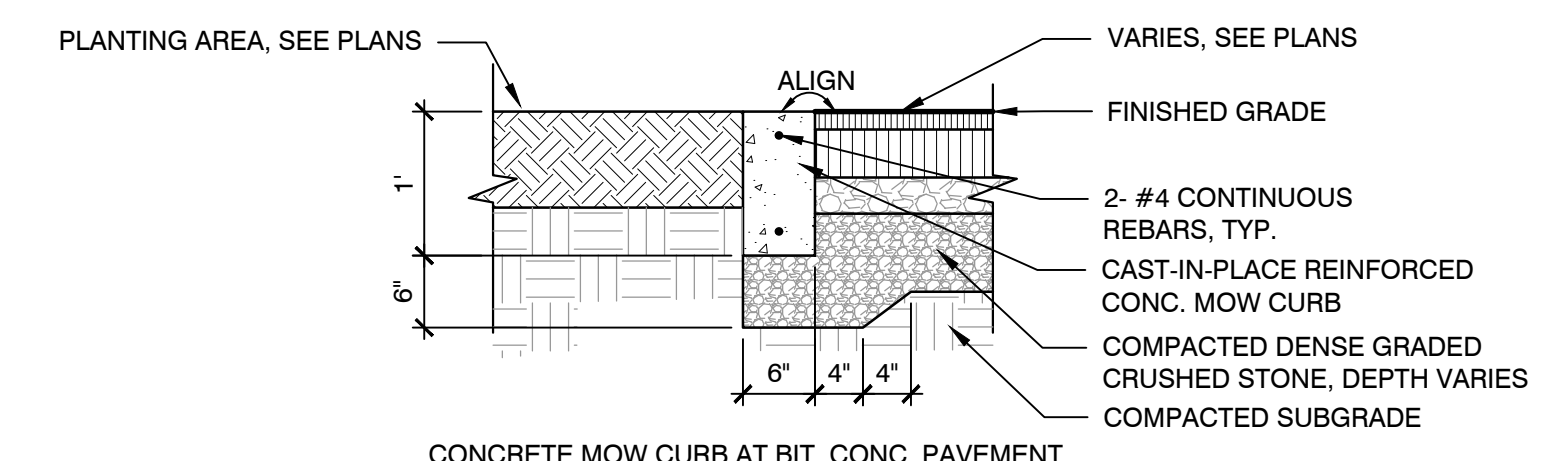
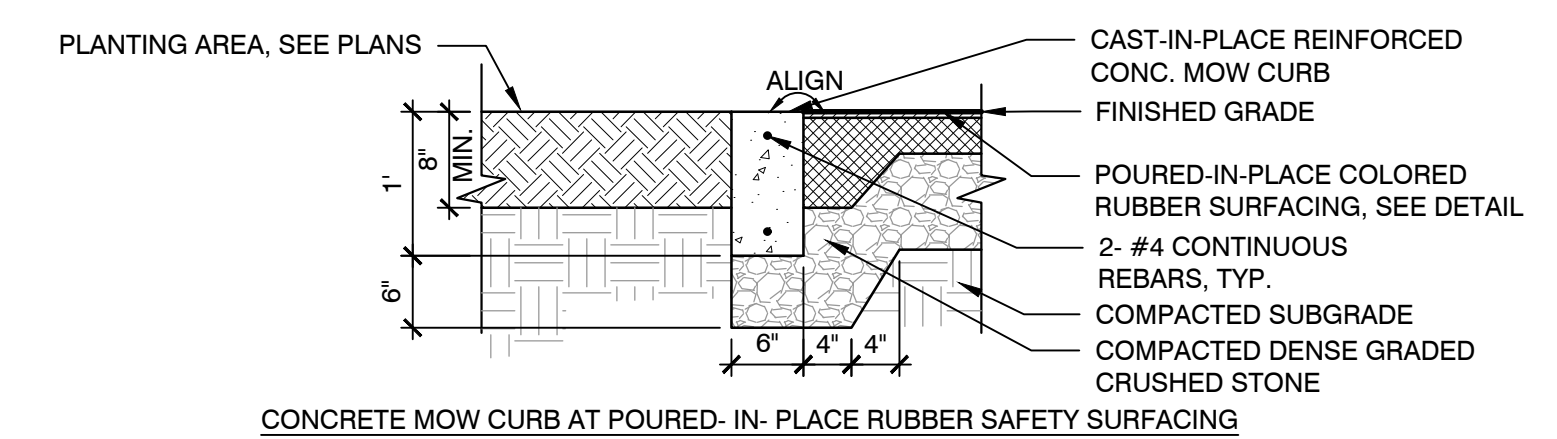

8 CONCRETE MOW STRIP
 SCALE: N.T.S.



- NOTES:
1. BOTTOM 2 RAILS TO BE CROSS WELDED.
 2. FENCE MESH FABRIC TO BE FIRST QUALITY BLACK VINYL. SEE SPECIFICATIONS.
 3. BAND-IT BUCKLES SHALL BE USED TO FASTEN FENCE MESH TO ALL POSTS AND RAILS.

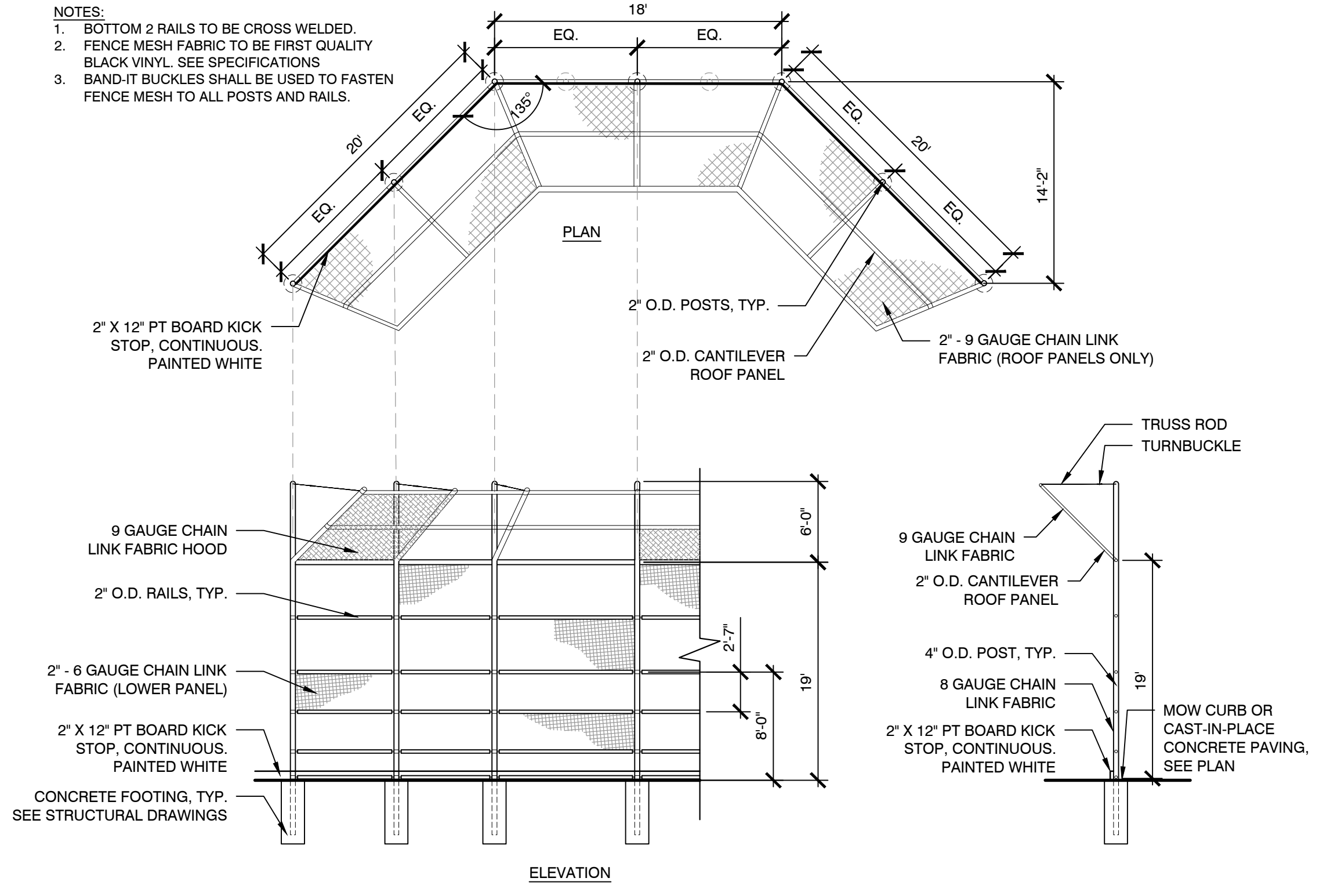

1 25' HT. BACKSTOP
SCALE: N.T.S.

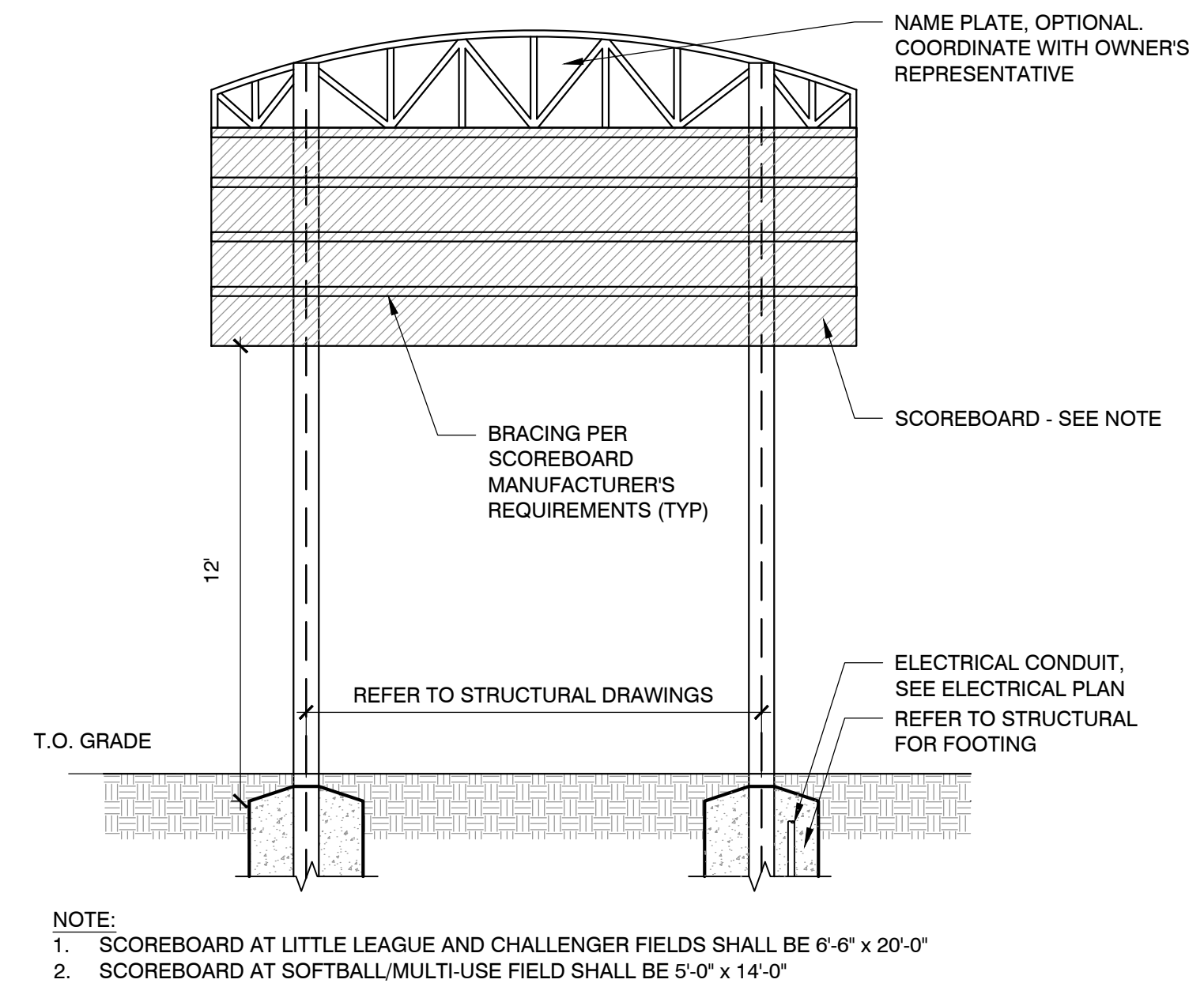

2 SCOREBOARD
SCALE: N.T.S.

- NOTE:
1. SCOREBOARD AT LITTLE LEAGUE AND CHALLENGER FIELDS SHALL BE 6'-6" x 20'-0"
 2. SCOREBOARD AT SOFTBALL/MULTI-USE FIELD SHALL BE 5'-0" x 14'-0"

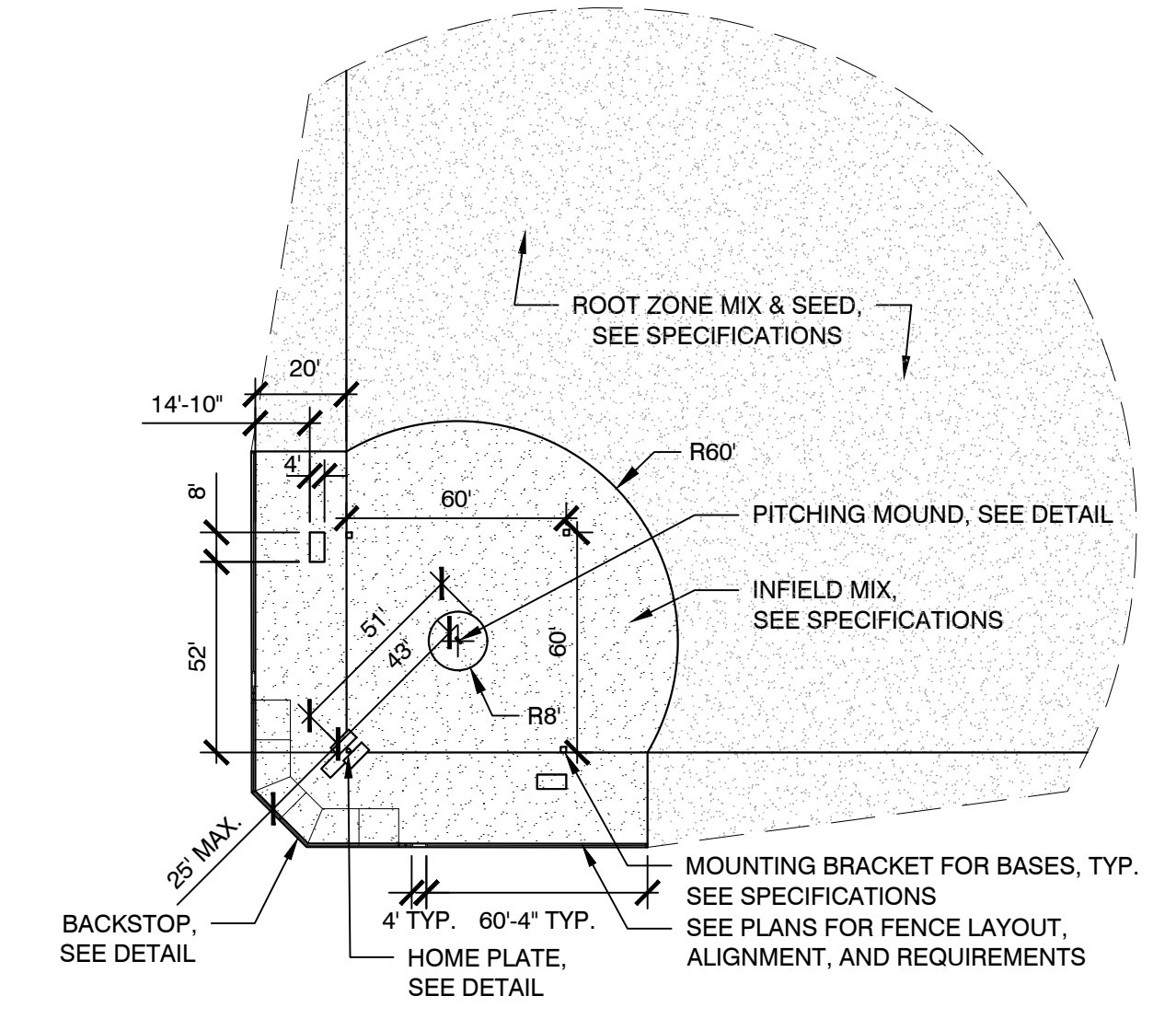

3 SOFTBALL FIELD
SCALE: N.T.S.

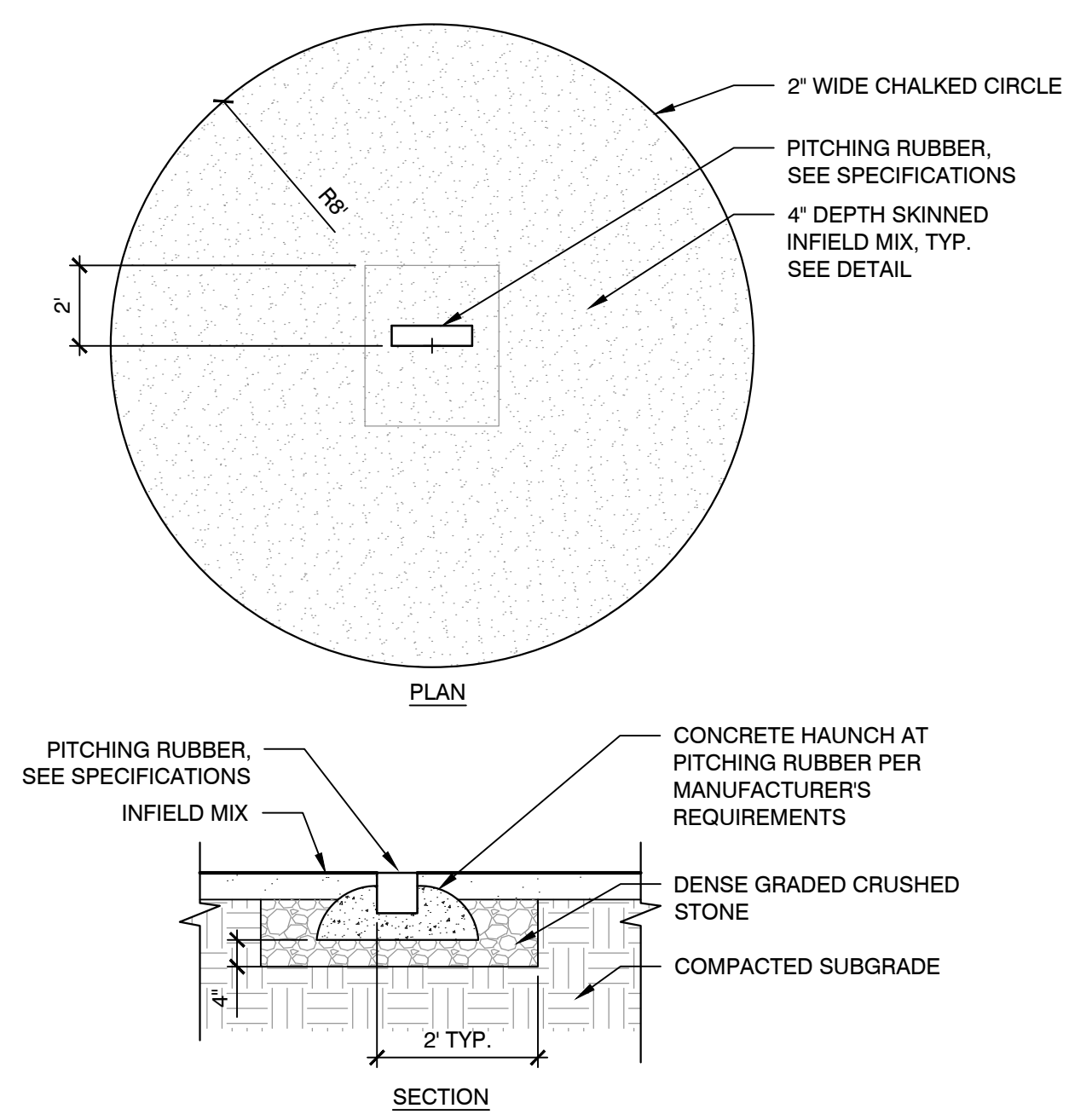

4 SOFTBALL PITCHERS MOUND
SCALE: N.T.S.

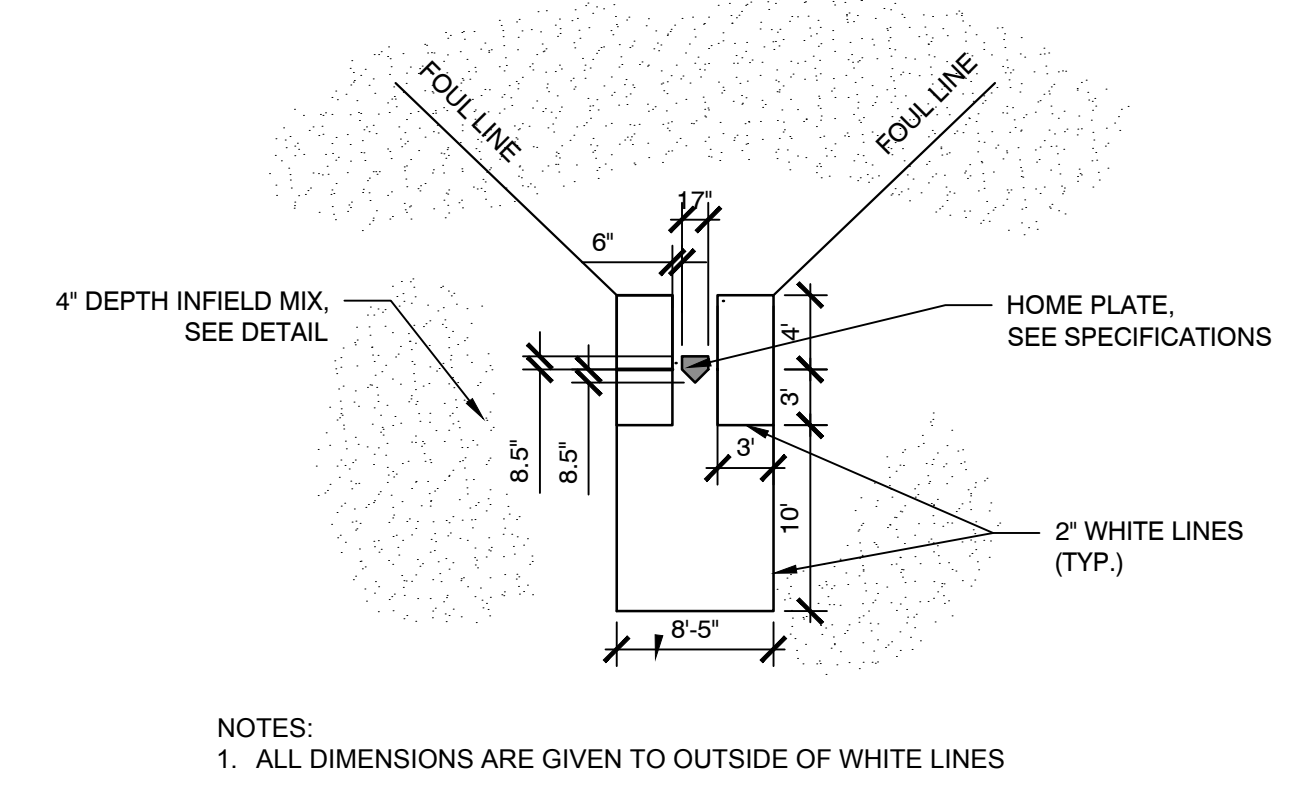

5 SOFTBALL HOMEPLATE
SCALE: N.T.S.

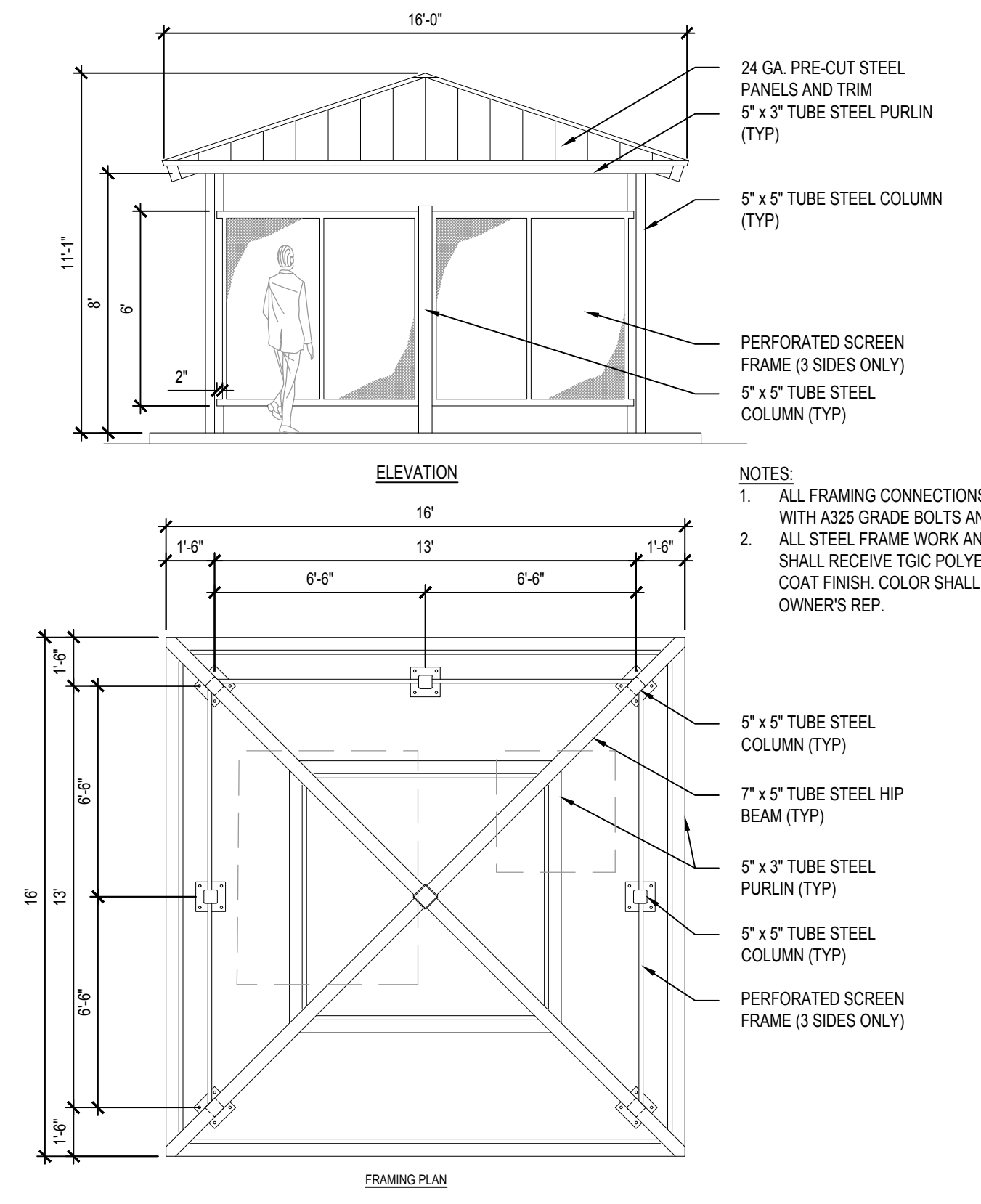

6 PORTABLE RESTROOM SHELTER
SCALE: N.T.S.



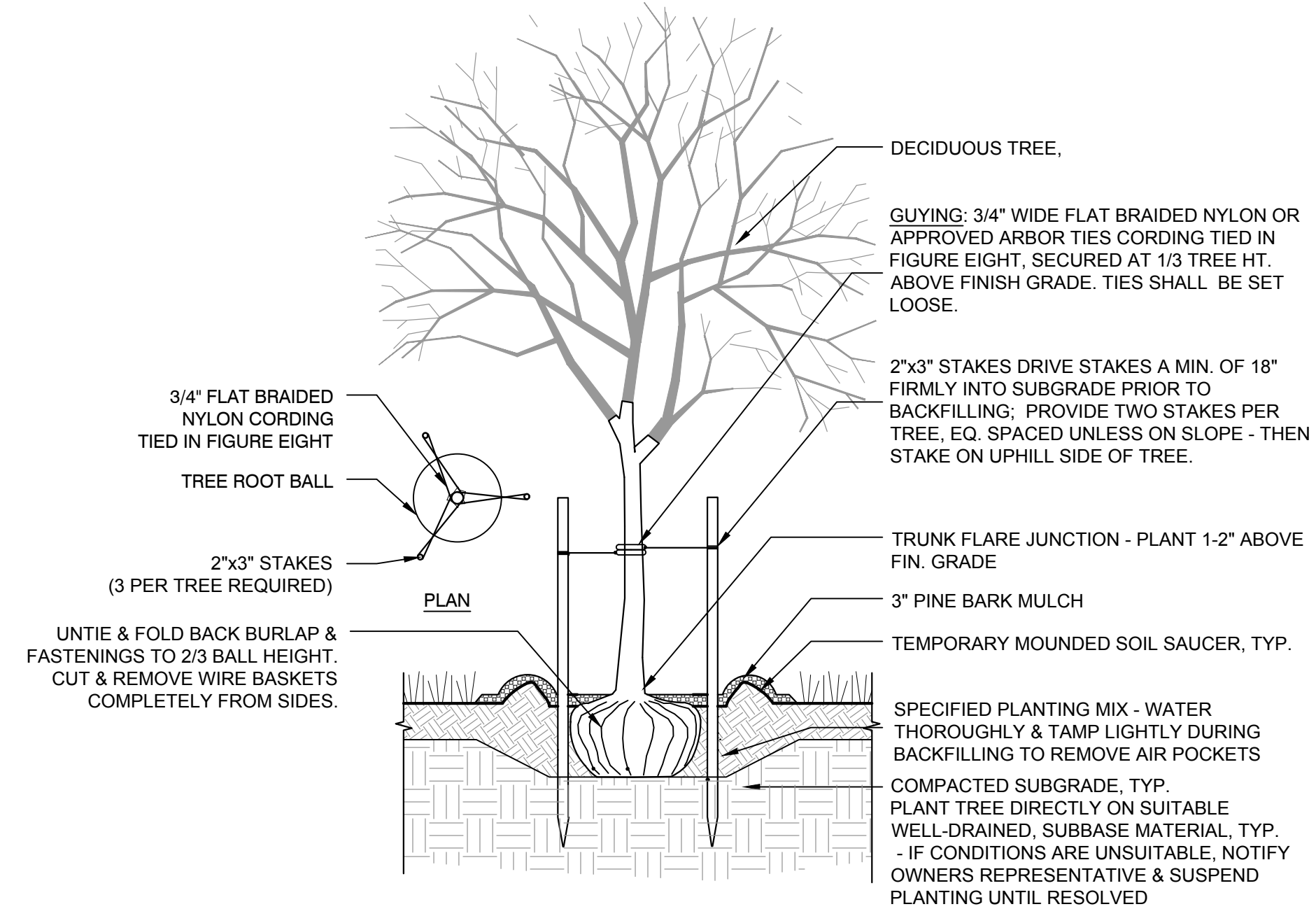

1 TREE PLANTING AT LANDSCAPE
SCALE: N.T.S.

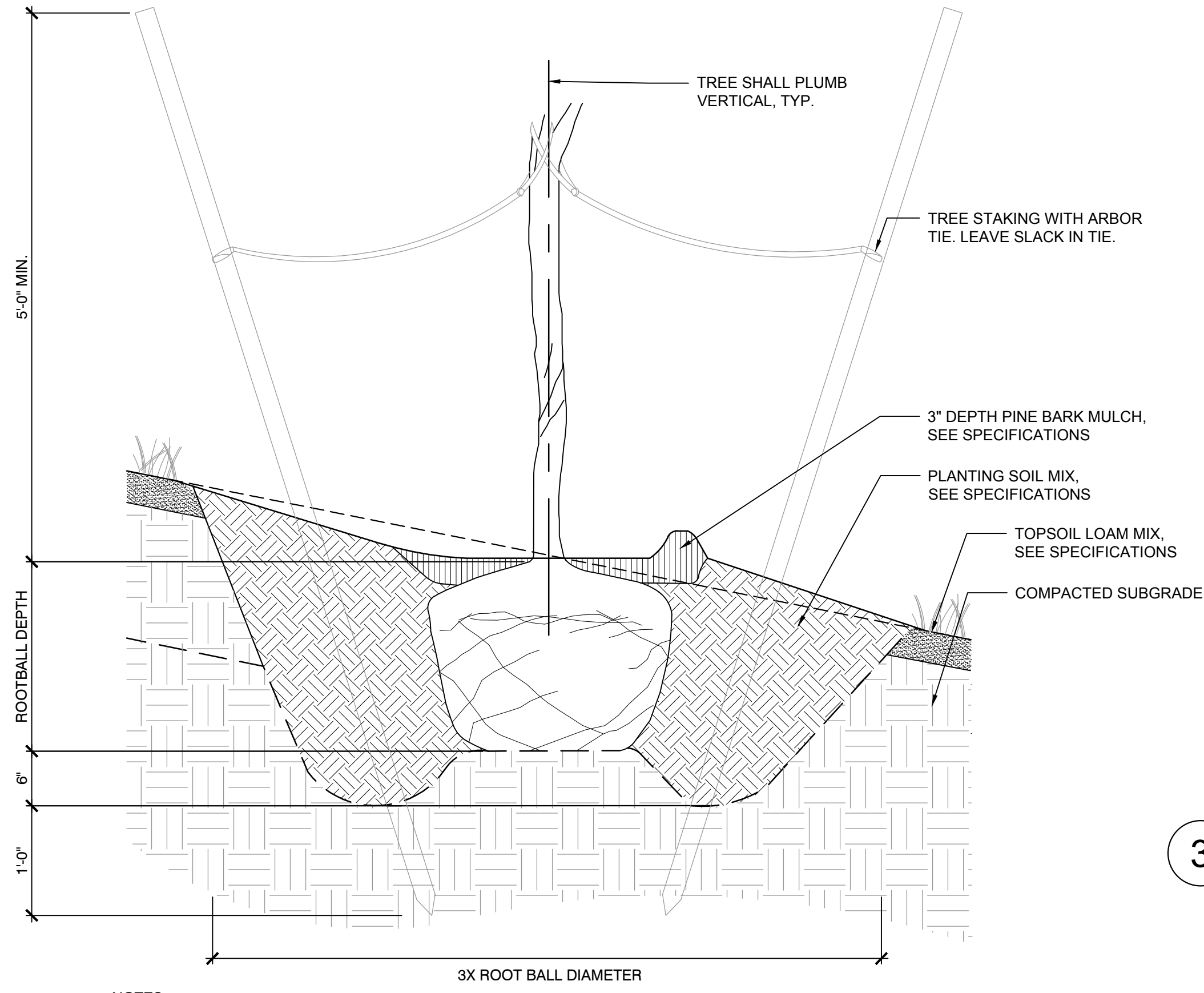

2 TREE PLANTING ON SLOPE
SCALE: N.T.S.

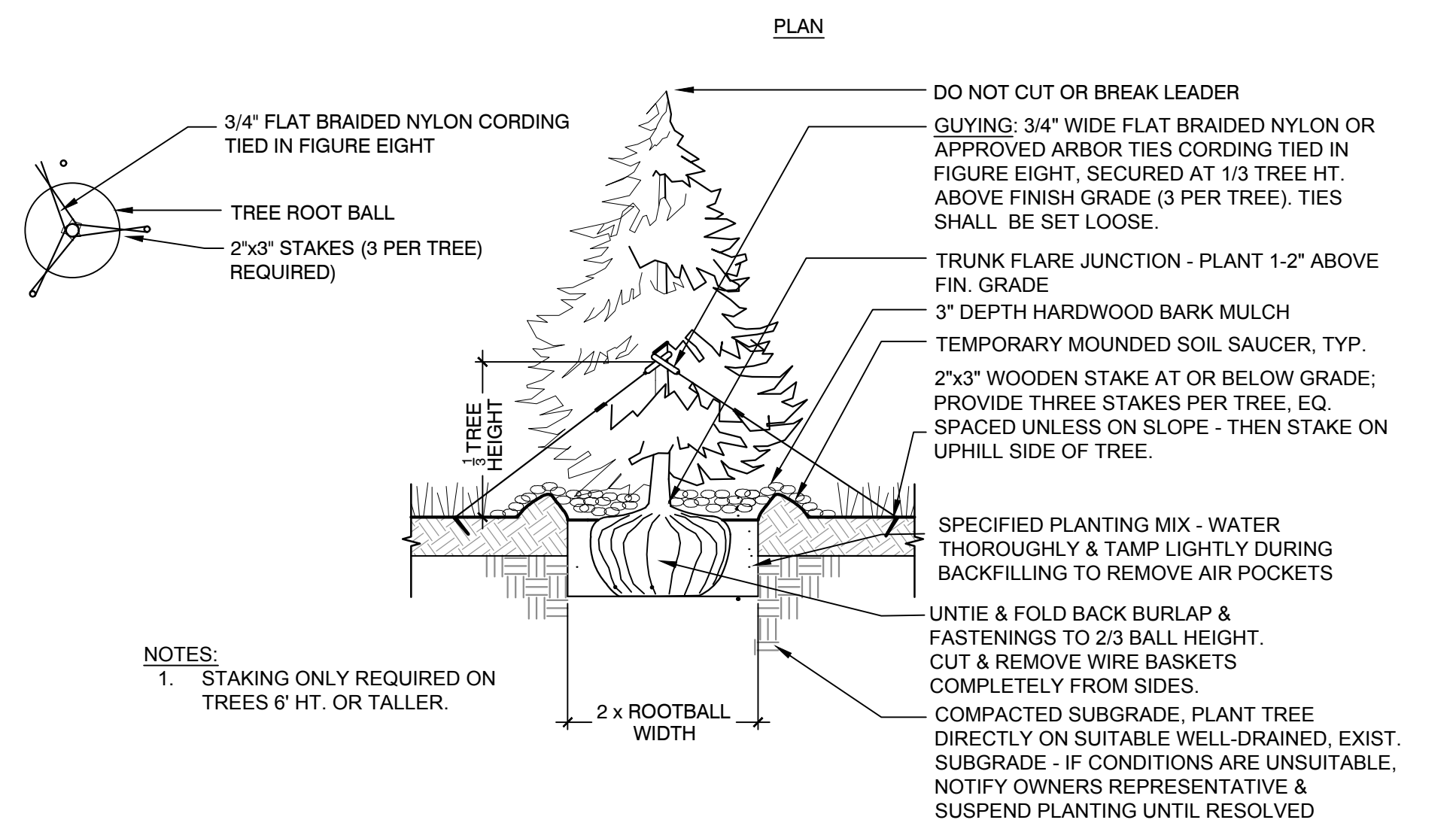

3 EVERGREEN TREE PLANTING
SCALE: N.T.S.

NOTES:
 1. SCOPE VARIES. SEE GRADING PLANS 3:1 MAX. SLOPE PLANTING. CONTRACTOR SHALL NOTIFY OWNER'S REPRESENTATIVE IF SLOPES ARE GREATER THAN 3:1.
 2. OWNER'S REPRESENTATIVE AND CONTRACTOR SHALL MARK NORTH SIDE OF TREE AT NURSERY AND LOCATE TREE AT SAME ORIENTATION WHEN INSTALLING.
 3. REMOVE 2/3 OF BURLAP WRAP AND WIRE BASKET OR TO THE GREATEST EXTENT POSSIBLE WITHOUT COMPROMISING THE STRUCTURAL INTEGRITY OF ROOTBALL.

GROUND COVER SPACING TABLE

PLANT SPACING 'A'	PLANT SPACING 'B'	PLANTS	AREA UNIT
6" O.C.	5.2"	4.61	1 SQ. FT.
8" O.C.	6.93"	2.6	1 SQ. FT.
10" O.C.	8.66"	1.66	1 SQ. FT.
12" O.C.	10.4"	1.15	1 SQ. FT.

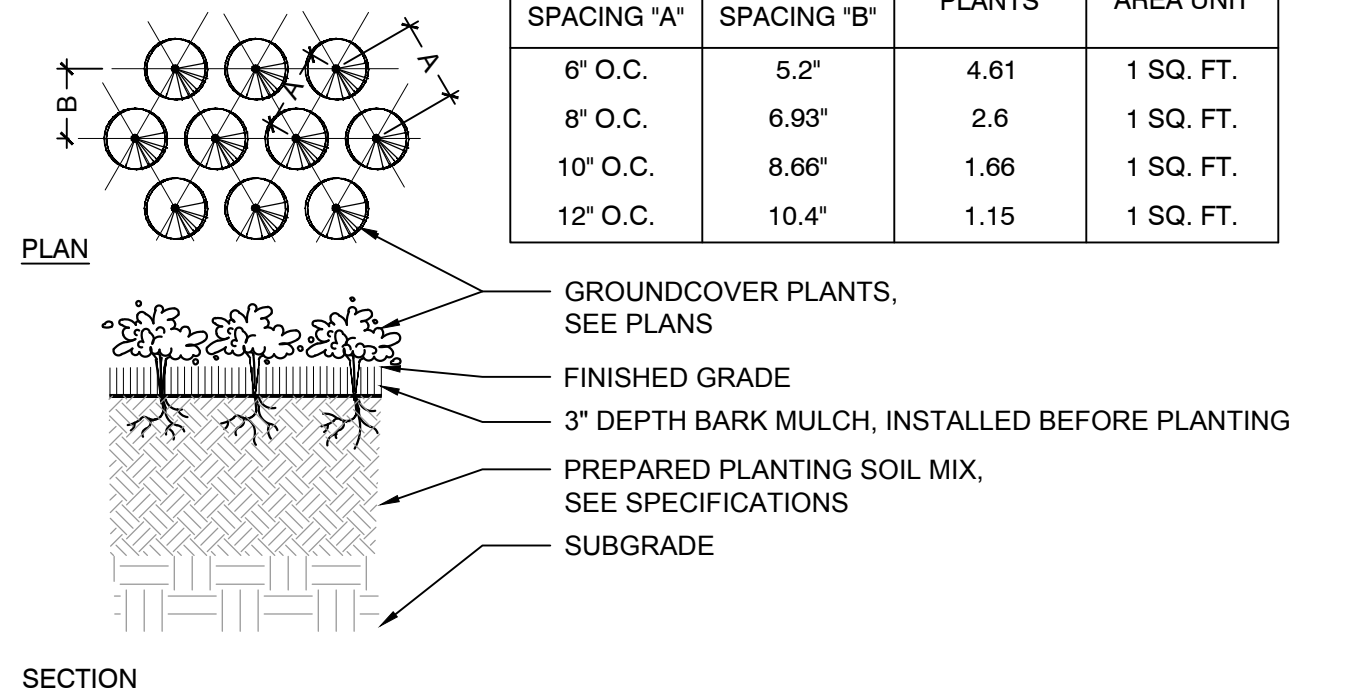

4 LOAM AND SEED
SCALE: N.T.S.

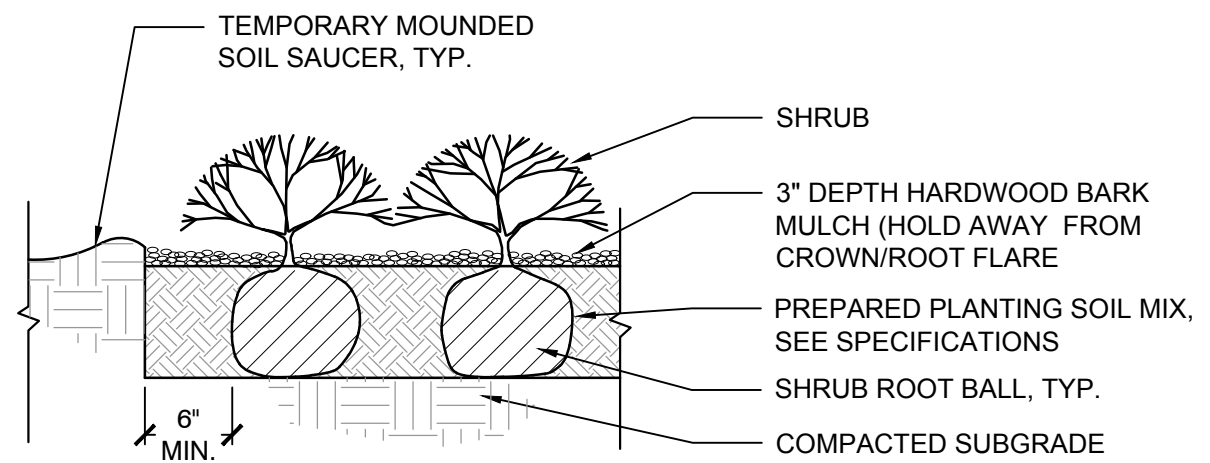

5 SHRUB PLANTING
SCALE: N.T.S.

NOTE:
 1. ALL MULCH MUST BE DARK IN COLOR. PROVIDE SAMPLE PRIOR TO INSTALLATION TO BE APPROVED BY OWNER'S REPRESENTATIVE.

NOTES:
 1. ALL GROUNDCOVERS TO BE PLANTED IN TRIANGULAR PATTERN. SEE PLANTING SCHEDULE FOR SPACING.
 2. JUTE EROSION CONTROL MAT TO BE USED ON ALL SLOPES 3:1 OR GREATER. SEE SPECIFICATIONS

6 GROUND COVER PLANTING
SCALE: N.T.S.



	Prepared By:	 NORTH	<table border="1" style="width:100%; border-collapse: collapse;"> <tr> <th>No.</th> <th>Date</th> <th>Revision</th> </tr> <tr> <td> </td> <td> </td> <td> </td> </tr> </table>	No.	Date	Revision				Project Name.: IMPROVEMENTS TO McCONNELL PARK	<table border="1" style="width:100%; border-collapse: collapse;"> <tr> <td colspan="2">BWSC SUBMISSION</td> </tr> <tr> <td>Date</td> <td>FEBRUARY 2021</td> </tr> <tr> <td>Scale</td> <td> </td> </tr> <tr> <td>Drawn</td> <td>ENB, LSR</td> </tr> <tr> <td>Checked</td> <td>CFR</td> </tr> </table>	BWSC SUBMISSION		Date	FEBRUARY 2021	Scale		Drawn	ENB, LSR	Checked	CFR	Sheet Name.: CONSTRUCTION DETAILS	SHEET: L7.14
	No.		Date	Revision																			
BWSC SUBMISSION																							
Date	FEBRUARY 2021																						
Scale																							
Drawn	ENB, LSR																						
Checked	CFR																						
	Consultant Project No. 2160850	Approved By: _____ Date: _____																					

1.0 - GENERAL

- 1.01 THE STRUCTURAL DRAWINGS SHALL BE USED IN CONJUNCTION WITH ALL OTHER CONTRACT DRAWINGS AND SPECIFICATIONS. REFER TO CIVIL, ARCHITECTURAL, MECHANICAL, PLUMBING, AND ELECTRICAL DRAWINGS FOR LOCATION, DIMENSIONS, AND DETAILS OF OPENINGS, SLEEVES, EMBEDMENTS, INSERTS, PADS, CURBS, DEPRESSIONS, ANCHOR BOLTS, AND OTHER PROJECT REQUIREMENTS NOT SHOWN ON STRUCTURAL DRAWINGS.
- 1.02 THE CONTRACTOR IS RESPONSIBLE FOR CHECKING, COORDINATING AND VERIFYING ALL DIMENSIONS IN THE FIELD PRIOR TO COMMENCING WORK. THE CONTRACTOR SHALL IMMEDIATELY REPORT ANY DISCREPANCY TO THE ARCHITECT AND ENGINEER AS A REQUEST FOR INFORMATION (RFI) BEFORE PROCEEDING WITH WORK.
- 1.03 THE CONTRACTOR IS RESPONSIBLE FOR VERIFYING IN THE FIELD THE EXISTENCE AND LOCATION OF OVERHEAD, BURIED AND/OR EMBEDDED UTILITIES, AND DETERMINING LOCATIONS OF ALL EMBEDDED MECHANICAL, ELECTRICAL AND PLUMBING SYSTEMS AFFECTED BY THE WORK OF THIS CONTRACT.
- 1.04 ALL WORK IS TO CONFORM WITH THE FOLLOWING CODES AND STANDARDS:
 - (A) "780 CMR: MASSACHUSETTS AMENDMENTS MASSACHUSETTS STATE BUILDING CODE" - 9TH EDITION (MSBC)
 - (B) INTERNATIONAL BUILDING CODE, (IBC 2015)
 - (C) "BUILDING CODE REQUIREMENTS FOR STRUCTURAL CONCRETE" - AMERICAN CONCRETE INSTITUTE (ACI 318)
 - (D) "MANUAL OF STEEL CONSTRUCTION" - AMERICAN INSTITUTE OF STEEL CONSTRUCTION (AISC 360)
 - (E) "STRUCTURAL WELDING CODE - STEEL" - AMERICAN WELDING SOCIETY (AWS D1.1)
 - (F) "SEISMIC PROVISION FOR STRUCTURAL STEEL BUILDINGS" - AMERICAN INSTITUTE OF STEEL CONSTRUCTION, (AISC)
 - (G) "MINIMUM DESIGN LOADS FOR BUILDINGS AND OTHER STRUCTURES" - AMERICAN SOCIETY OF CIVIL ENGINEERS, (ASCE 7-10)

FOR ADDITIONAL CODES AND STANDARDS REFER TO SPECIFICATIONS.
- 1.05 THE CONTRACTOR SHALL NOTIFY THE ARCHITECT AND ENGINEER OF UNFORSEEN CONDITIONS THAT MAY BE UNCOVERED DURING DEMOLITION AND CONSTRUCTION AS A REQUEST FOR INFORMATION (RFI) BEFORE PROCEEDING WITH WORK.
- 1.06 PERMANENT STRUCTURAL ELEMENTS TO BE DESIGNED IN ACCORDANCE WITH PERFORMANCE SPECIFICATIONS INCLUDE, BUT ARE NOT LIMITED TO, THE FOLLOWING:
 - (A) PREFABRICATED RESTROOM STRUCTURE
 - (B) PREFABRICATED DUGOUT STRUCTURE
 - (C) PREFABRICATED SCOREBOARD STRUCTURES

FOR PERFORMANCE DESIGN REQUIREMENTS OF ELEMENTS LISTED ABOVE, REFER TO ADDITIONAL NOTES ON THESE SHEETS AND IN THE TECHNICAL SPECIFICATIONS. ALL DESIGN SUBMITTAL DRAWINGS AND CALCULATIONS SHALL BE CERTIFIED, SIGNED AND SEALED BY A PROFESSIONAL STRUCTURAL ENGINEER REGISTERED IN THE STATE OF MASSACHUSETTS.
- 1.07 STRUCTURAL REQUIREMENTS TO ACCOMMODATE FIXED EQUIPMENT, INCLUDING BUT NOT LIMITED TO ROOF TOP UNITS ARE INCIDENTAL TO THE REQUIREMENTS OF A SPECIFIC EQUIPMENT MANUFACTURER. ALL WORK SHALL CONFORM TO APPROVED EQUIPMENT MANUFACTURER'S SHOP DRAWINGS AND INSTALLATION INSTRUCTIONS. THE CONTRACTOR SHALL SUBMIT TO THE ENGINEER FOR APPROVAL ANY REQUIRED MODIFICATIONS TO ACCOMMODATE APPROVED EQUIPMENT DRAWINGS. SUCH MODIFICATIONS SHALL BE MADE AT NO COST TO THE OWNER.
- 1.08 DETAILS AND NOTES SHOWN ON STRUCTURAL DRAWINGS SHALL BE APPLICABLE TO ALL PARTS OF THE STRUCTURAL WORK EXCEPT WHERE SPECIFICALLY REQUIRED OTHERWISE BY CONTRACT DOCUMENTS. CONDITIONS NOT SPECIFICALLY SHOWN SHALL BE TO THOSE SHOWN FOR LIKE CONDITIONS AS DETERMINED BY THE ENGINEER.
- 1.09 IN ACCORDANCE WITH SPECIFICATION SECTION 01 45 00, TESTING AND INSPECTION OF STRUCTURAL WORK SHALL BE THE RESPONSIBILITY OF THE CONTRACTOR. THE COSTS FOR TESTING AND INSPECTIONS WILL BE PAID BY THE CONTRACTOR. PROVIDE TEST RESULTS TO THE ENGINEER IN A TIMELY MANNER.
- 1.10 THE CONTRACTOR SHALL DESIGN AND PROVIDE ALL REQUIRED SHORING AND TEMPORARY BRACING TO RESIST FORCES ON THE STRUCTURE THROUGHOUT THE CONSTRUCTION PERIOD.

2.0 - FOUNDATIONS

- 2.01 THE SUBSURFACE CONDITIONS DESCRIBED IN THE DRAWINGS, SPECIFICATIONS, TEST BORINGS AND TEST PITS ARE INCLUDED ONLY TO ASSIST THE CONTRACTOR DURING BIDDING AND SUBSEQUENT CONSTRUCTION AND REPRESENT CONDITIONS ONLY AT THESE SPECIFIC LOCATIONS AT THE TIME THEY ARE MADE.
- 2.02 THE CONTRACTOR SHALL DESIGN AND PROVIDE ALL TEMPORARY EARTH SUPPORT, SHORING AND BRACING REQUIRED TO PERFORM THE WORK IN ACCORDANCE WITH OSHA, STATE AND LOCAL REQUIREMENTS.
- 2.03 THE CONTRACTOR SHALL DESIGN AND PROVIDE SHEETING, SHORING, BRACING, AND/OR UNDERPINNING IN ORDER TO PROTECT EXISTING UTILITIES FROM EXCESSIVE MOVEMENTS DURING THE CONSTRUCTION PERIOD, IN ACCORDANCE WITH OSHA, STATE & LOCAL REQUIREMENTS.
- 2.04 THE CONTRACTOR SHALL CARRY OUT CONTINUOUS CONTROL OF SURFACE AND SUBSURFACE WATER, DEWATER ANY AREAS REQUIRING EXCAVATION IN ADVANCE OF PERFORMING EXCAVATION. MAINTAIN GROUNDWATER LEVELS AT LEAST 2 FEET BELOW PLANNED SUBGRADES.
- 2.05 ALL SUBGRADES TO RECEIVE FILL MATERIALS, FOUNDATIONS, SLABS OR OTHER CONSTRUCTION SHALL BE FREE OF RUNNING OR STANDING WATER PRIOR TO PLACEMENT.
- 2.06 SPREAD FOOTINGS AND PIERS AS SHOWN ARE DESIGNED FOR ESTIMATED METAL BUILDING REACTIONS AND ARE APPROXIMATE IN SIZE. THESE ELEMENTS ARE SUBJECT TO CHANGE IN DIMENSION (IF REQUIRED) WITH THE APPROVED METAL BUILDING SUBMITTAL. ANY CHANGES SHALL COME AT NO ADDITIONAL COST TO THE OWNER.
- 2.07 FOUNDATIONS SHALL BE INSTALLED IN THE GEOMETRY SHOWN IN THE PLANS, ANY ROCK ENCOUNTERED DURING EXCAVATION SHALL BE REMOVED TO CLEAR THE REQUIRED FOUNDATION GEOMETRY.
- 2.08 SPREAD FOOTING BEARING SURFACES SHALL BE EXCAVATED BY EQUIPMENT WITH A SMOOTH, TOOTHLESS CUTTING EDGE.
- 2.09 THE GEOTECHNICAL REPORT PREPARED BY WESTON & SAMPSON DATED 07/22/20 IS PROVIDED FOR INFORMATION PURPOSES ONLY.

3.0 - CAST IN PLACE CONCRETE

- 3.01 CONCRETE WORK SHALL CONFORM TO "BUILDING CODE REQUIREMENTS FOR REINFORCED CONCRETE" (ACI 318) AND "SPECIFICATIONS FOR STRUCTURAL CONCRETE FOR BUILDINGS" (ACI 301).
- 3.02 CONCRETE SHALL BE CONTROLLED CONCRETE, PROPORTIONED, MIXED AND PLACED IN THE PRESENCE OF A REPRESENTATIVE OF AN APPROVED TESTING AGENCY.
- 3.03 UNLESS NOTED OTHERWISE, CONCRETE SHALL BE NORMAL WEIGHT AND HAVE A MINIMUM 28 DAY COMPRESSIVE STRENGTH AS FOLLOWS:
 - (A) FOUNDATIONS: 4000 PSI
 - (B) EXTERIOR SLABS AND WALKWAYS: 5000 PSI
- 3.04 ALL PERMANENTLY EXPOSED VERTICAL AND HORIZONTAL CONCRETE SURFACES SHALL BE TREATED OR SEALED IN ACCORDANCE WITH PROJECT SPECIFICATIONS.
- 3.05 CONCRETE WORK SHALL BE COORDINATED WITH ALL METAL BUILDINGS, ARCHITECTURAL, MECHANICAL, PLUMBING, ELECTRICAL WORK, AND ALL EQUIPMENT. THE CONTRACTOR SHALL VERIFY INSTALLATION AND LOCATIONS OF ALL EMBEDDED ITEMS INCLUDING BUT NOT LIMITED TO INSERTS, ANCHOR BOLTS, DOWELS, BLOCKOUTS, SLEEVES, EMBEDDED PIPING, AND EMBEDDED CONDUIT PRIOR TO CONCRETE PLACEMENT.
- 3.06 FOR STRUCTURAL ELEMENTS, THE LOCATIONS AND MAXIMUM SPACINGS OF VERTICAL JOINTS SHALL BE AS FOLLOWS:

ELEMENT	JOINT TYPE	SPACING, FT.	LOCATIONS
FOUNDATION WALL	CONTRACTION	30	FACE OF
FOUNDATION WALL	CONSTRUCTION	60	PILASTER
- 3.07 FOR SLABS-ON-GRADE, LOCATE CONSTRUCTION OR CONTROL JOINTS ALONG COLUMN LINES OR AS SHOWN. PROVIDE JOINTS AT 20FT. MAX. SPACING. SUBMIT JOINT LOCATIONS AND DETAILS FOR APPROVAL.
- 3.08 SEALANT FOR CONTROL/CONTRACTION JOINTS AND SAW CUT JOINTS SHALL BE SIKADUR 51 MANUFACTURED BY SIKA OR AN APPROVED EQUAL.
- 3.09 CONCRETE EXPOSED TO WEATHER (FREEZE-THAW CONDITIONS) IN THE FINISHED PROJECT SHALL BE AIR ENTRAINED PER SPECIFICATIONS REQUIREMENTS.

- 3.10 A MINIMUM OF 72 HOURS SHALL ELAPSE BETWEEN ADJACENT CONCRETE PLACEMENTS.
 - 3.11 CONCRETE SLABS SHALL BE PLACED SO THAT THE SLAB THICKNESS IS AT NO POINT LESS THAN THAT INDICATED ON THE DRAWINGS.
 - 3.12 PROVIDE A 3/4" CHAMFER ON ALL VERTICAL AND HORIZONTAL CORNERS EXPOSED TO VIEW UNLESS NOTED OTHERWISE.
 - 3.13 ALL CONCRETE SHALL BE WATER CURED UNLESS OTHERWISE AUTHORIZED BY THE ENGINEER.
 - 3.14 NON-SHRINK, NON-METALLIC, GROUT SHALL HAVE A MINIMUM 28-DAY COMPRESSIVE STRENGTH OF 7,500 PSI (ASTM C942) AND A MINIMUM BOND STRENGTH OF 2,000 PSI AT 28-DAYS (ASTM C882). GROUT MAY BE EXTENDED WITH COARSE AGGREGATE PER THE MANUFACTURER'S RECOMMENDATIONS.
- 4.0 - CAST IN PLACE CONCRETE REINFORCEMENT
- 4.01 REINFORCEMENT DETAILING, FABRICATION, AND ERECTION SHALL CONFORM TO "ACI DETAILING MANUAL" - SP-66, "CRSI MANUAL OF STANDARD PRACTICE".
 - 4.02 STEEL REINFORCEMENT, UNLESS NOTED OTHERWISE, SHALL CONFORM TO THE FOLLOWING:
 - (A) BARS, TIES, AND STIRRUPS: ASTM A615 GRADE 60
 - (B) WELDED WIRE FABRIC: ASTM A185, FLAT SHEETS
 - 4.03 REINFORCING STEEL SHALL BE UNCOATED AND DEFORMED.
 - 4.04 MINIMUM CONCRETE PROTECTIVE COVERING FOR REINFORCEMENT, UNLESS REQUIRED FOR FIRE PROTECTION OR NOTED OTHERWISE, SHALL BE AS FOLLOWS:
 - (A) CONCRETE CAST AGAINST AND PERMANENTLY EXPOSED TO EARTH: 3"
 - (B) CONCRETE EXPOSED TO EARTH OR WEATHER:
 - (1) NO. 6 THRU NO. 18 BARS: 2"
 - (2) NO. 5 BAR, W31 OR D31 WIRE AND SMALLER: 2"
 - (C) SURFACES NOT EXPOSED TO WEATHER OR IN CONTACT WITH GROUND:
 - (1) SLABS, WALLS, JOISTS:
 - (a) NO. 14 AND NO 18 BARS: 2"
 - (b) NO. 11 BARS AND SMALLER: 2"
 - (2) BEAMS, COLUMNS:
 - (a) PRIMARY REINFORCEMENT: 2-1/2"
 - (b) TIES, STIRRUPS, SPIRALS: 2"
 - 4.05 REINFORCING STEEL SHALL BE CONTINUOUS THROUGH ALL CONSTRUCTION JOINTS, CORNERS, AND INTERSECTIONS UNLESS OTHERWISE NOTED. REINFORCING SHALL BE LAPPED AT NECESSARY SPLICES OR HOOKED AT DISCONTINUOUS ENDS, UNLESS OTHERWISE NOTED.
 - 4.06 FOR REINFORCING STEEL SPLICE LAP LENGTHS REFER TO THE TABLE PROVIDED UNLESS OTHERWISE INDICATED.
 - 4.07 MECHANICAL SPLICES SHALL BE PERMITTED SUBJECT TO APPROVAL BY THE ENGINEER. MECHANICAL SPLICES SHALL DEVELOP AT LEAST 125 PERCENT OF THE SPECIFIED YIELD STRENGTH OF THE BAR. NO WELDED CONNECTIONS ARE PERMITTED.
 - 4.08 WELDED WIRE FABRIC SHALL BE LAPPED (1) SQUARE PLUS (2) INCHES WHERE REQUIRED AND SHALL BE WIRED TOGETHER AT ALL LAPS. WWF SHALL BE SUPPORTED BY CHAIRS AND/OR CARRYING BARS PRIOR TO CONCRETE PLACEMENT.
 - 4.09 REINFORCEMENT SHALL NOT BE TACK WELDED.
 - 4.10 NOTIFY THE TESTING LAB AND ENGINEER A MINIMUM OF 48 HOURS PRIOR TO SCHEDULED CONCRETE PLACEMENT IN ORDER TO ACCOMMODATE INSPECTION OF REINFORCEMENT AND CONCRETE TESTING. NO CONCRETE SHALL BE PLACED WITHIN 48 HOURS OF SUCH NOTIFICATION.
 - 4.11 WHERE REINFORCEMENT IS NOT SHOWN ON DRAWINGS, PROVIDE REINFORCEMENT IN ACCORDANCE WITH APPLICABLE DETAILS AS DETERMINED BY THE ARCHITECT AND ENGINEER. IN NO CASE SHALL REINFORCEMENT BE LESS THAN THE MINIMUM REINFORCEMENT PERMITTED BY THE CODES, NOR LESS THAN THE FOLLOWING:
 - (A) BEAM STIRRUPS: #3 @ 12"
 - (B) BEAM STIRRUP SUPPORTS: 1-#5 AT EACH STIRRUP BEND
 - (C) FACE REINFORCEMENT IN BEAMS OR PORTIONS OF BEAMS #4 @ 12" E.F.
 - (D) STRUCTURAL SLABS: 0.0020 X GROSS CONCRETE AREA IN EACH DIRECTION
 - (E) CONCRETE WALLS: 0.0025 X GROSS CONCRETE AREA IN EACH DIRECTION
 - 4.12 WHERE REINFORCEMENT IS REQUIRED IN SECTION, REINFORCEMENT IS CONSIDERED TYPICAL WHEREVER THE SECTIONS APPLIES.
 - 4.13 WHERE THERE IS CONFLICT BETWEEN LOCATIONS OF COLUMN VERTICAL BARS AND BEAM HORIZONTAL BARS, THE COLUMN BARS SHALL REMAIN IN THEIR DESIGNATED POSITIONS AND BEAM BAR LOCATIONS SHALL BE ADJUSTED.
 - 4.14 DOWELS SHALL MATCH BAR SIZE, NUMBER AND SPACING, UNLESS NOTED OTHERWISE.

6.0 - STRUCTURAL STEEL

- 6.01 STRUCTURAL STEEL DESIGN, FABRICATION AND ERECTION SHALL CONFORM TO THE AISC "MANUAL OF STEEL CONSTRUCTION", "SPECIFICATION FOR STRUCTURAL STEEL BUILDINGS AND BRIDGES" (ANSI/AISC 360-10), AND "CODE OF STANDARD PRACTICE FOR STEEL BUILDINGS AND BRIDGES" (ANSI/AISC 303-10).
- 6.02 STRUCTURAL STEEL SHALL BE NEW STEEL CONFORMING TO THE FOLLOWING:
 - (A) WIDE FLANGE SHAPES: ASTM A992
 - (B) OTHER STEEL SHAPES, PLATES AND BARS: ASTM A572 OR ASTM A36.
 - (C) STRUCTURAL TUBING: ASTM A500 GR. B.
- 6.03 ALL WELDED CONNECTIONS SHALL BE MADE BY APPROVED CERTIFIED WELDERS AND SHALL CONFORM TO A.W.S. SPECIFICATIONS AMENDED TO DATE. ELECTRODES SHALL BE E70XX.
- 6.04 BOLTS SHALL CONFORM TO ASTM A325 AND BE INSTALLED SNUG-TIGHT UNLESS NOTED OTHERWISE.
- 6.05 STRUCTURAL STEEL FRAMING SHALL BE WITHIN TOLERANCE BEFORE CONNECTIONS ARE FINALLY BOLTED OR WELDED.
- 6.06 FIELD CUTTING OF STRUCTURAL STEEL OR ANY FIELD MODIFICATIONS OF STRUCTURAL STEEL SHALL NOT BE MADE WITHOUT PRIOR WRITTEN APPROVAL BY THE ENGINEER FOR EACH SPECIFIC USE.
- 6.07 STRUCTURAL STEEL SHAPES AND PLATES EXPOSED TO WEATHER AND AT CANOPIES SHALL BE HOT-DIPPED GALVANIZED PER ASTM A123 UNLESS FASTENERS SHALL BE HOT-DIPPED GALVANIZED PER ASTM A153 UNLESS HOT-DIPPED GALVANIZING SHALL ALSO CONFORM TO ASTM A385. THE GALVANIZER SHALL SUBMIT A CERTIFICATE OF CONFORMANCE FOR RECORD.
- 6.08 PROVIDE FIELD TOUCH-UP AND REPAIR OF GALVANIZING AS REQUIRED PER ASTM A780 USING AN INORGANIC ZINC-RICH PRIMER.
- 6.09 WHEN DISSIMILAR METALS ARE IN CONTACT (E.G. STAINLESS STEEL IN CONTACT WITH GALVANIZED STEEL), COAT SURFACE WITH COAL TAR EPOXY OR PROVIDE OTHER APPROVED MEANS TO PROVIDE A BARRIER.
- 6.10 WELDS SHALL BE 1/4" FILLET WELDS MINIMUM UNLESS NOTED OTHERWISE ON THE DRAWINGS.
- 6.11 PROVIDE TEMPORARY ERECTION BRACING AND SUPPORTS TO HOLD STRUCTURAL STEEL FRAMING SECURELY IN POSITION. SUCH TEMPORARY BRACING AND SUPPORTS SHALL NOT BE REMOVED UNTIL PERMANENT BRACING HAS BEEN INSTALLED.
- 6.12 SUBMIT SHOP DRAWINGS AND PRODUCT DATA FOR APPROVAL PRIOR TO FABRICATION.

9.0 - DESIGN LOADS:

- 9.01 GENERAL DESIGN REQUIREMENTS (IBC 2015, SECTION 1604)
 - (A) RISK CATEGORY: I (ASCE 7-10, TABLE 1-1)
 - (B) MUNICIPALITY: BOSTON, MA (780 CMR, TABLE 1604.11)
- 9.03 FLOOR DESIGN LOADING CRITERIA LOADS (IBC 2015, SECTION 1607)

OCCUPANCY / USE	SUPERIMPOSED DEAD LOAD #	LIVE LOADS	
		UNIFORM	CONCENTRATED
LOBBIES, 1st FLOOR CORRIDORS, CONFERENCE	20 psf	100 psf	2000 lbs
SLABS-ON-GRADE	ACTUAL WEIGHT OF EQUIPMENT	250 psf OR HS-20 #	-
ROOF	5 psf #	20 psf #	-
HANDRAIL AND GUARDRAIL SYSTEMS	-	50 lb/ft #	200 lbs #
INTERMEDIATE RAILS & PANEL FILLERS	-	50 lb/ft #	-

NOTE(S):

- (a) SUPERIMPOSED DEAD LOADS ARE APPLIED IN ADDITION TO FRAMING AND SLAB SELF-WEIGHTS.
 - (c) ROOF LIVE LOAD, ALSO REFER TO SNOW LOAD REQUIREMENTS IN 9.04.
 - (d) NOT CONCURRENT WITH THE UNIFORM LOAD. THE CONCENTRATED LOAD ON STAIR TREADS SHALL BE APPLIED ON AN AREA OF 2 INCHES BY 2 INCHES.
 - (e) APPLIED IN ANY DIRECTION ALONG THE HANDRAIL OR TOP RAIL TO PRODUCE THE MAXIMUM EFFECTS. UNIFORM AND CONCENTRATED LOADS ARE NOT APPLIED CONCURRENTLY.
 - (f) APPLIED NORMAL TO THE SURFACE ON AN AREA NOT TO EXCEED 12"x12" (NOT CONCURRENT WITH TOP RAIL LOADS).
 - (g) VEHICLE LOADING PER IBC 2015 1607.7.
- 9.04 ROOF SNOW LOAD (IBC 2015, SECTION 1608)
 - (A) GROUND SNOW LOAD, Pg: 40 PSF (780 CMR, TABLE 1604.11)
 - (B) MINIMUM FLAT ROOF SNOW LOAD, Pf: 30 PSF (MA, STATE BUILDING CODE CHAPTER 18 (AMENDED))
 - (C) SNOW EXPOSURE FACTOR, Ce: 1.0 (ASCE 7-10, TABLE 7-2)
 - (D) THERMAL FACTOR, Ct: 1.2 (ASCE 7-10, TABLE 7-3)
 - (E) SNOW LOAD IMPORTANCE FACTOR, Is: 1.0 (ASCE 7-10, TABLE 7-4)
 - (F) ROOF SLOPE FACTOR, Cs: 1.0 (ASCE 7-10, FIGURE 7-2)
 - (G) * ADJUST FOR SNOW DRIFT AND UNBALANCED SNOW LOADING (MSBC 780 CMR)
 - 9.05 WIND LOADS (IBC 2015, SECTION 1609)
 - (A) BASIC WIND SPEED, V (3-SECOND GUST WIND SPEED): 128 MPH (780 CMR, TABLE)
 - (B) BUILDING ENCLOSURE CLASSIFICATION: PARTIALLY ENCLOSED (ASCE 7-10, SEC. 6.2)
 - (C) WIND EXPOSURE CATEGORY: D (ASCE 7-10, SEC. 6.5.6.3)
 - (D) DESIGN BUILDING DIMENSIONS
 - (E) COMPONENTS AND CLADDING (ASCE 7-10, SEE TABLE)
 - (F) ANALYSIS PROCEDURE: LOW RISE BUILDINGS (ASCE 7-10)
 - (G) WIND DIRECTIONALITY FACTOR, Kd: 0.85 (ASCE 7-10, TABLE 26.6-1)
 - (H) TOPOGRAPHIC FACTOR, Kzt: 1.0 (ASCE 7-10, SECTION 26.8)
 - (I) VELOCITY PRESSURE COEFFICIENT, Kz: 0.85 (ASCE 7-10, TABLE 27.3-1)
 - (J) INTERNAL PRESSURE COEFFICIENT, Gcpi: +/-0.18 (ASCE 7-10, TABLE 26.11-1)
 - 9.06 EARTHQUAKE LOADS (IBC 2015, SECTION 1613)
 - (A) SITE CLASS: E (GEOTECH REPORT)
 - (B) SPECTRAL RESPONSE ACCELERATIONS:
 - (1) Ss: 0.227 (780 CMR, TABLE 1604.11)
 - (2) S1: 0.072 (780 CMR, TABLE 1604.11)
 - (C) SPECTRAL RESPONSE COEFFICIENTS:
 - (1) Sds: 0.242 (ASCE 7-10, SEC. 11.4.3)
 - (2) Sd1: 0.115 (ASCE 7-10, SEC. 11.4.3)
 - (D) SEISMIC DESIGN CATEGORY: C (ASCE 7-10, SEC. 11.6-1)
 - (E) SEISMIC IMPORTANCE FACTOR, Is: 1.5 (ASCE 7-10, TABLE 11.5-1)
 - (F) SEISMIC FORCE RESISTING SYSTEM: (780 CMR, TABLE 12.2-1)
 - (1) STEEL SYSTEM NOT SPECIFICALLY DETAILED FOR SEISMIC RESISTANCE
 - (a) RESPONSE MODIFICATION COEFFICIENT, R: 3
 - (b) SYSTEM OVERSTRENGTH PARAMETER, Omega_p: 3
 - (c) DEFLECTION AMPLIFICATION FACTOR, Cd: 3
 - (G) ANALYSIS PROCEDURE: EQUIVALENT LATERAL FORCE ANALYSIS (ASCE 7-10, SEC. 12.8)

FOR PERMITTING
NOT FOR CONSTRUCTION



Prepared By:

Consultant Project No. 2160850



No.	Date	Revision

Approved By: _____ Date: _____

Project Name.: **IMPROVEMENTS TO McCONNELL PARK**

PERMITTING DOCUMENTS - NOT FOR CONSTRUCTION

Date	FEBRUARY 2021
Scale	
Drawn	AAC
Checked	NMS

Sheet Name.: **STRUCTURAL GENERAL NOTES**

SHEET: **S0.01**

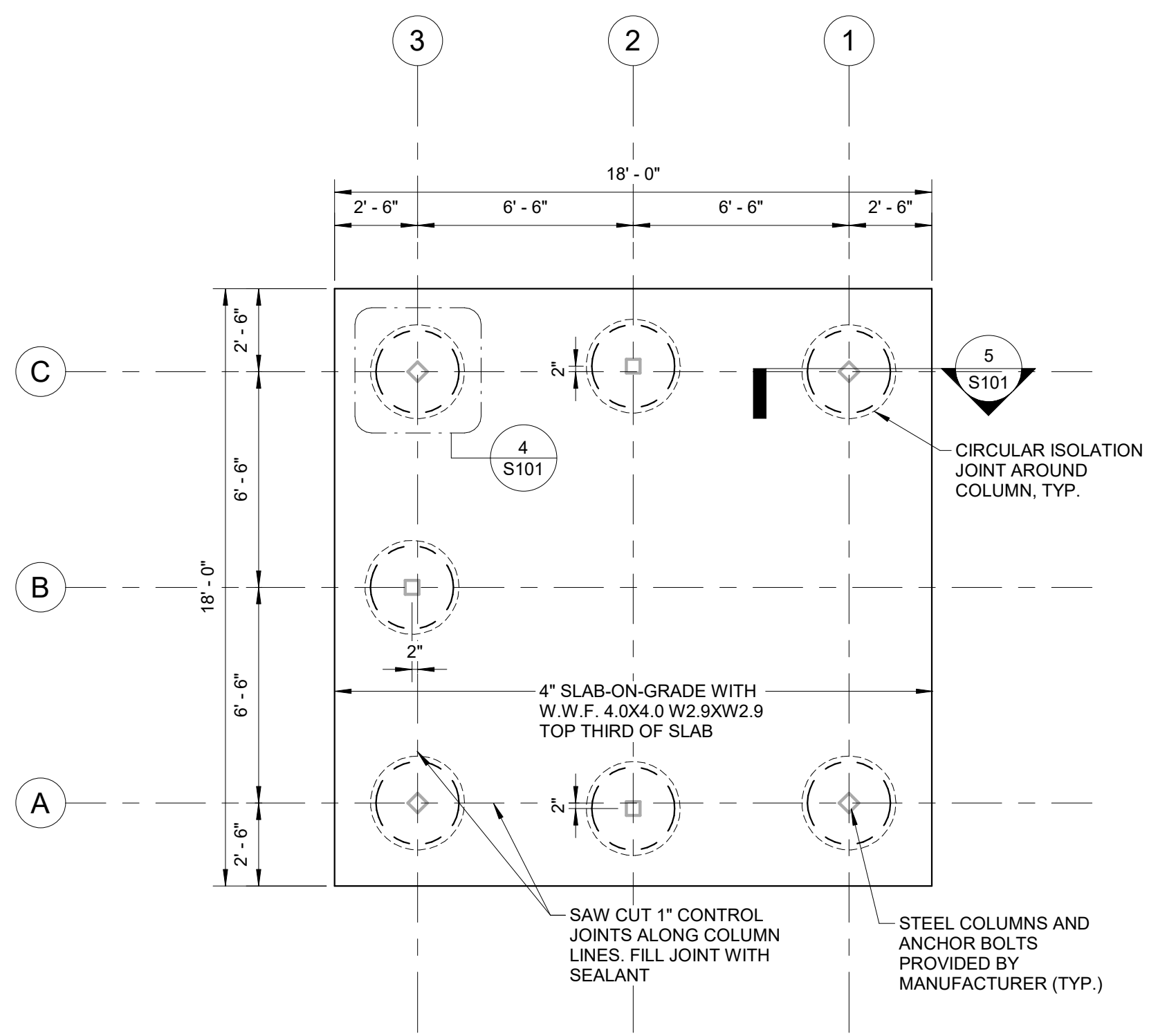

NOTES:
1. COORDINATE FOUNDATION LAYOUT AND STEEL CONNECTIONS WITH RESTROOM ENCLOSURE MANUFACTURER

1 RESTROOM STRUCTURE SLAB PLAN
SCALE: 1/4" = 1'-0"

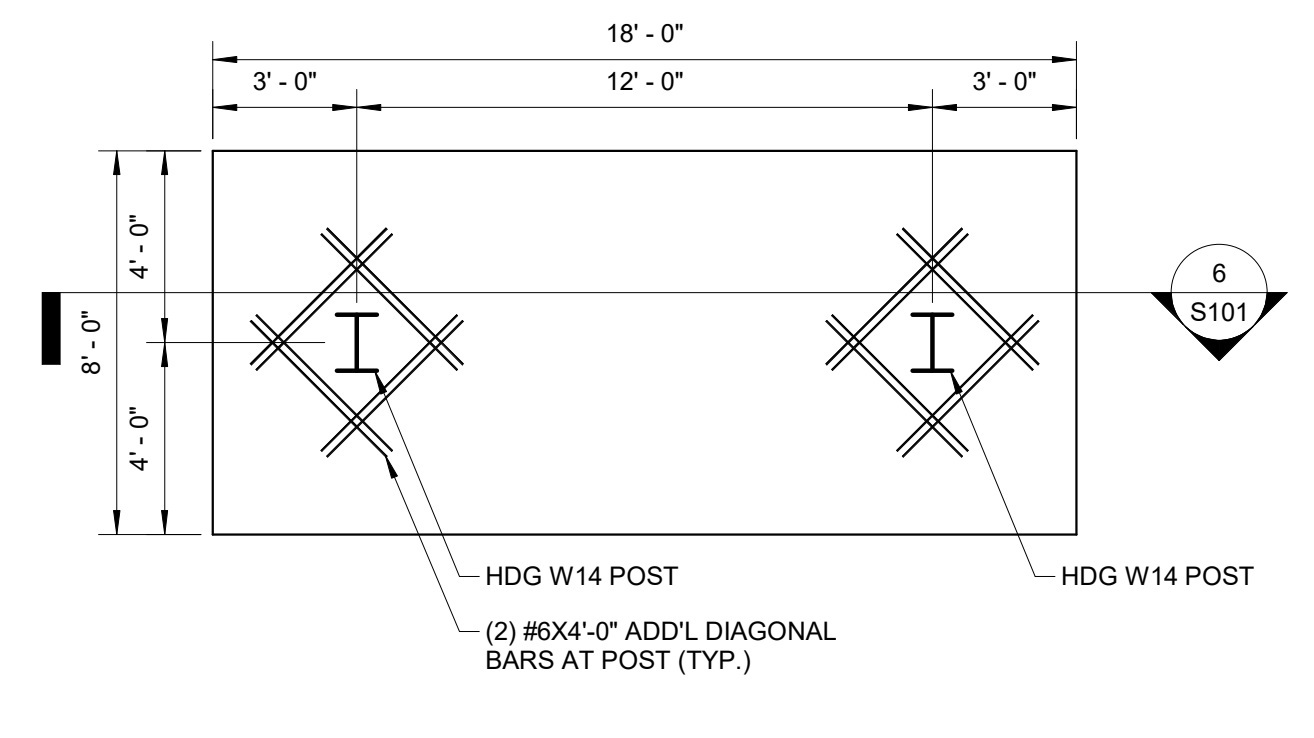

2 LITTLE LEAGUE SCOREBOARD FOUNDATION PLAN
SCALE: 1/4" = 1'-0"

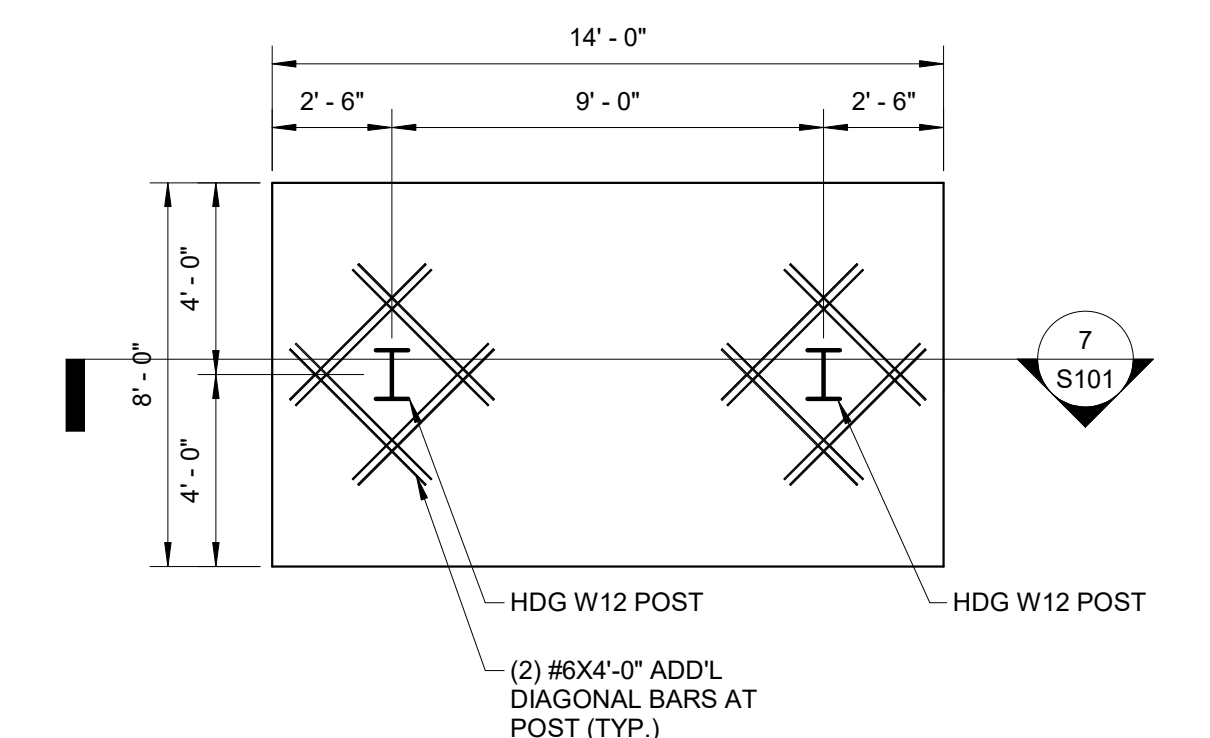

3 CHALLENGER SCOREBOARD FOUNDATION PLAN
SCALE: 1/4" = 1'-0"

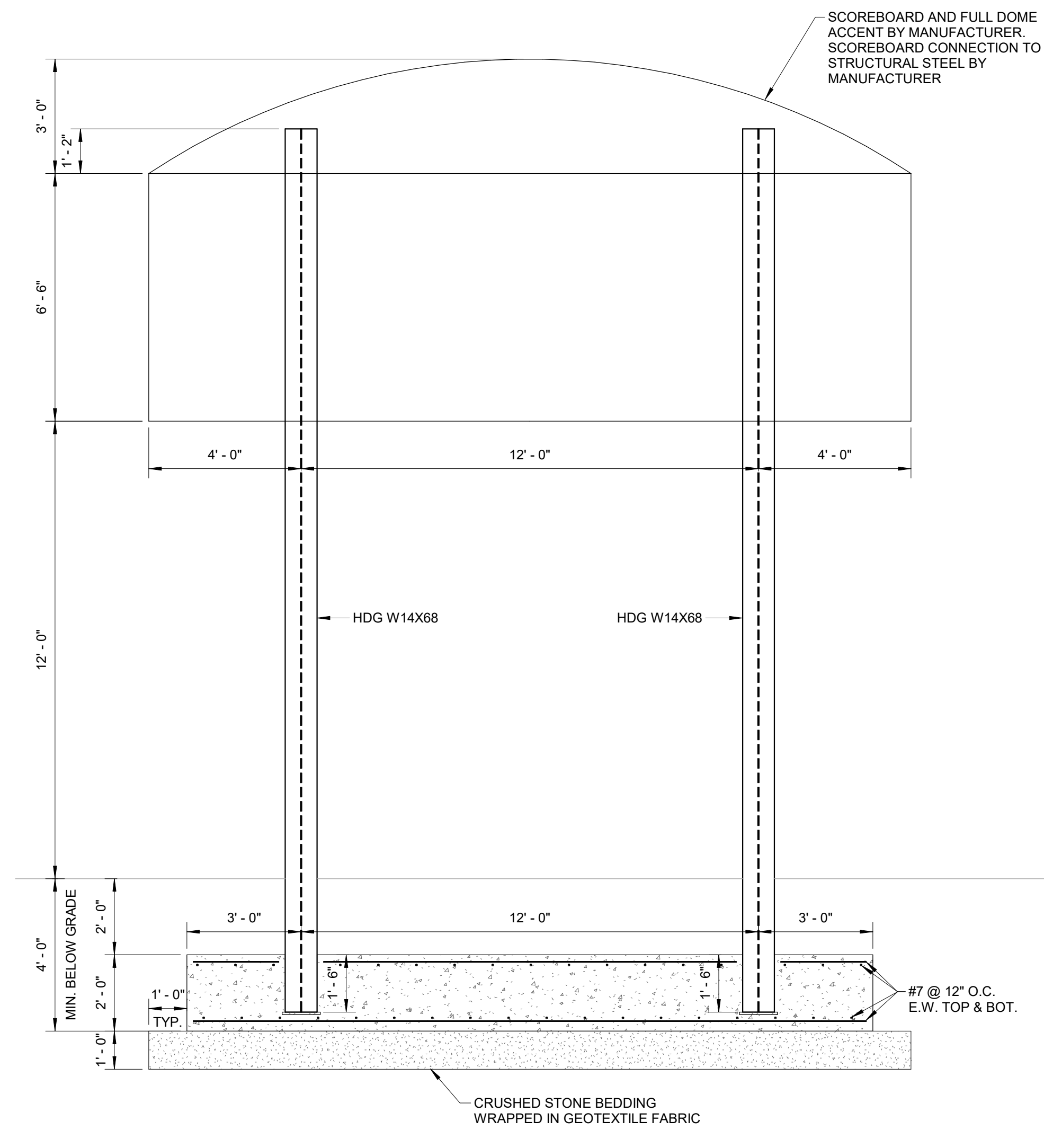

6 LITTLE LEAGUE SCORE BOARD SECTION
SCALE: 3/8" = 1'-0"

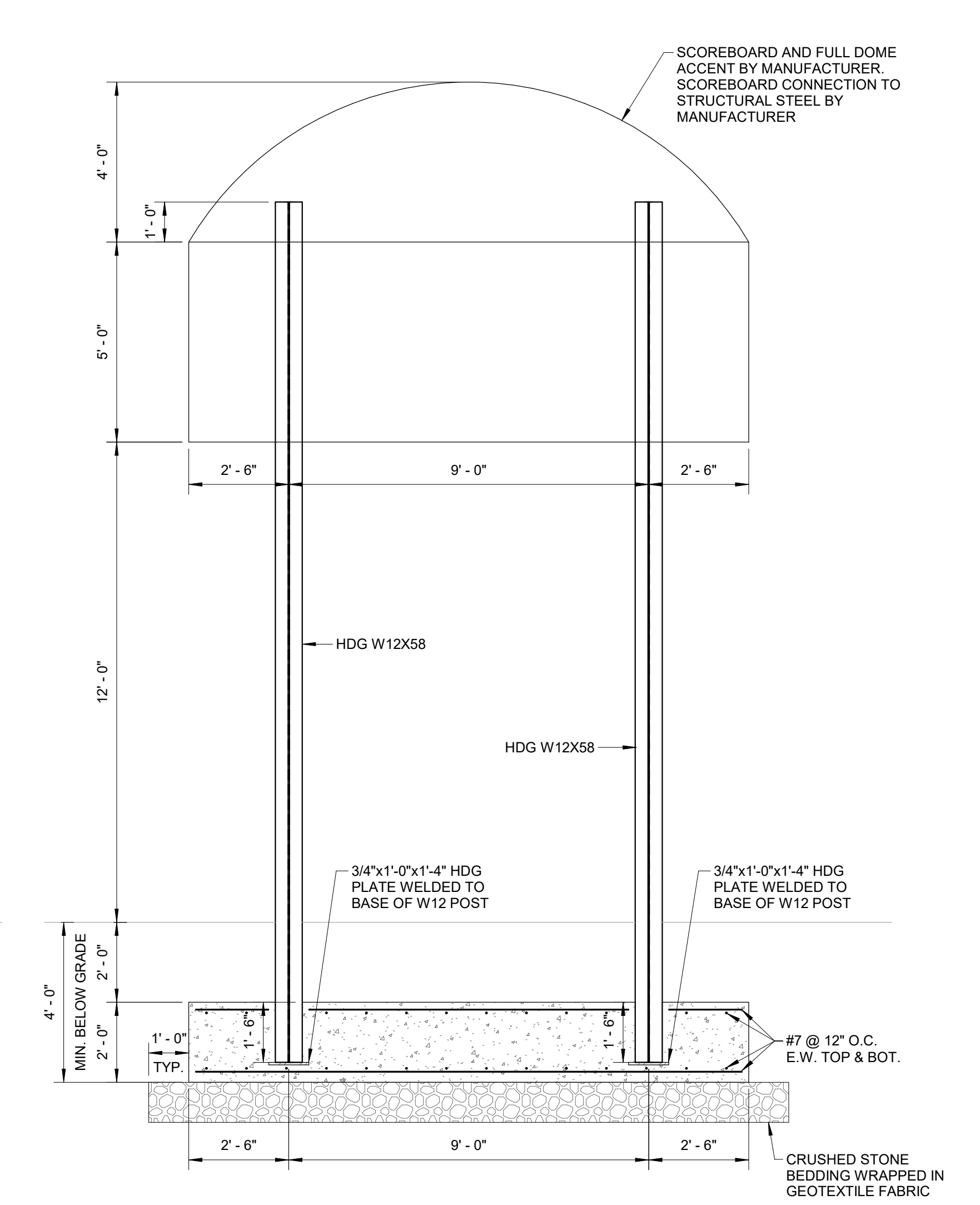

7 CHALLENGER SCOREBOARDS SECTION
SCALE: 3/8" = 1'-0"

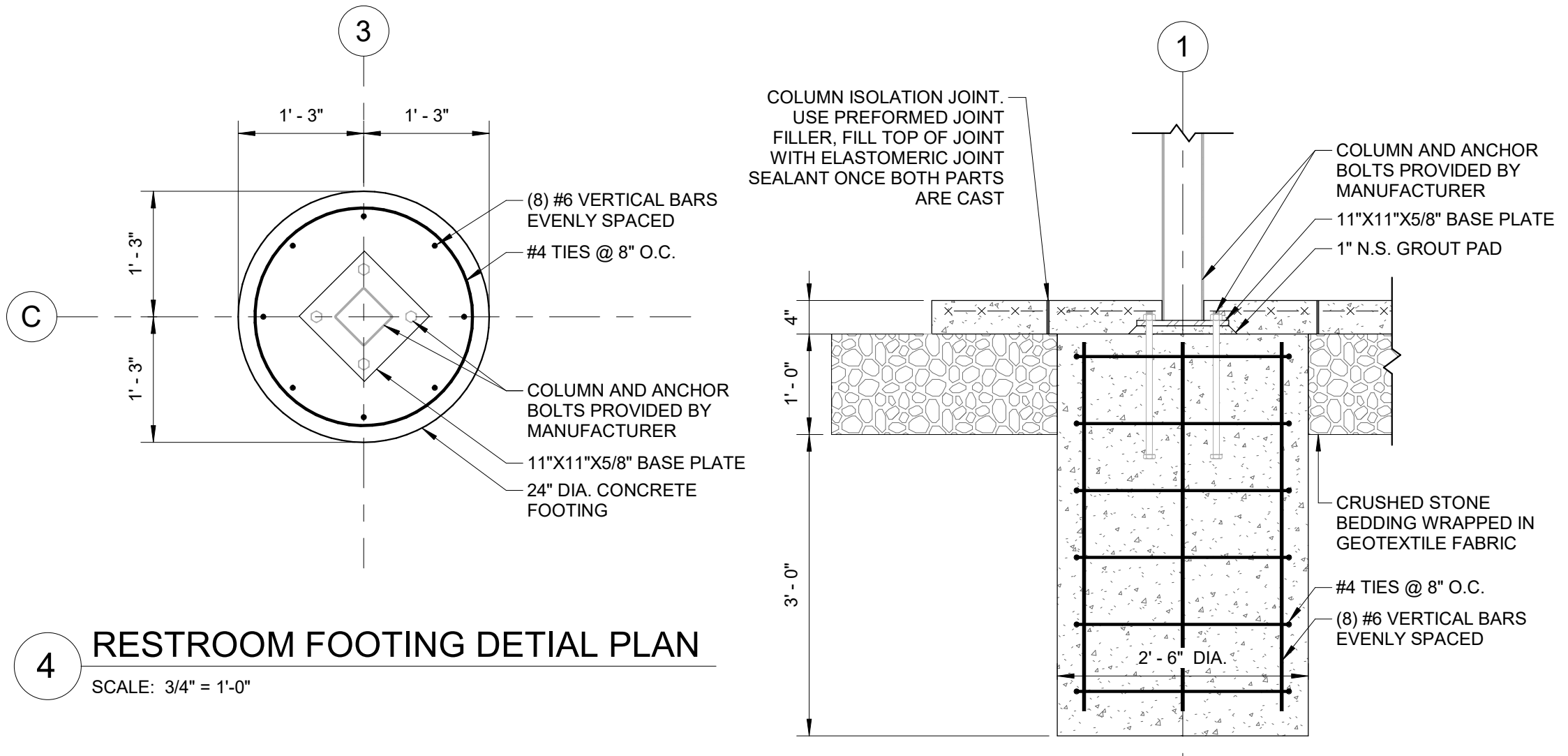

4 RESTROOM FOOTING DETAIL PLAN
SCALE: 3/4" = 1'-0"

5 SECTION @ RESTROOM FOOTING
SCALE: 3/4" = 1'-0"

FOR PERMITTING
NOT FOR CONSTRUCTION



Prepared By:
Weston & Sampson
Consultant Project No. 2160850



No.	Date	Revision

Approved By: _____ Date: _____

Project Name:
IMPROVEMENTS TO McCONNELL PARK

PERMITTING DOCUMENTS - NOT FOR CONSTRUCTION
Date: FEBRUARY 2021
Scale: _____
Drawn: AAC
Checked: NMS

Sheet Name:
ENLARGED FOUNDATION PLANS AND DETAILS I

SHEET:
S5.01

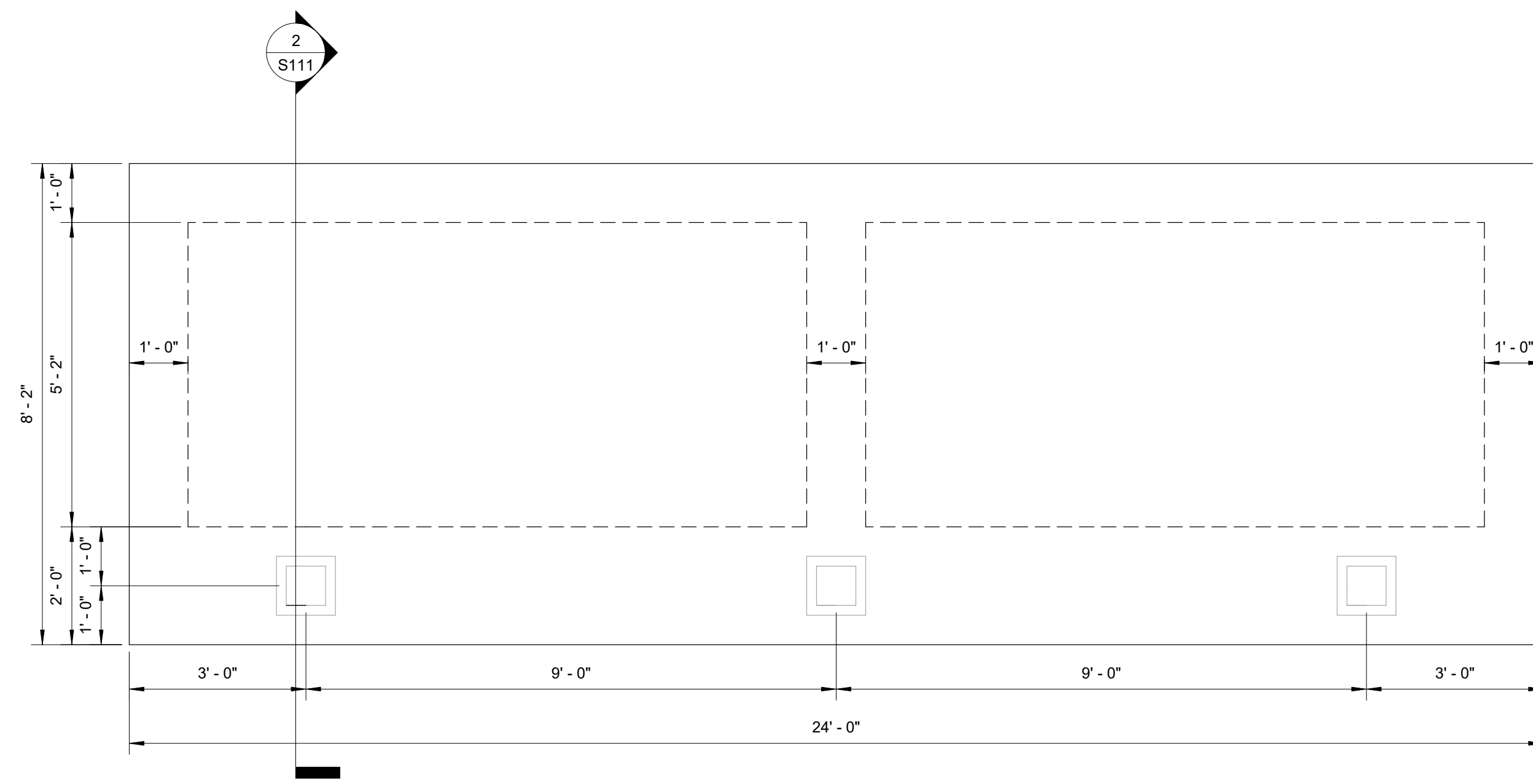

NOTE:
1. COORDINATE FOUNDATION WITH DUGOUT STRUCTURE

1 DUGOUT FOUNDATION PLAN
SCALE: 1/2" = 1'-0"

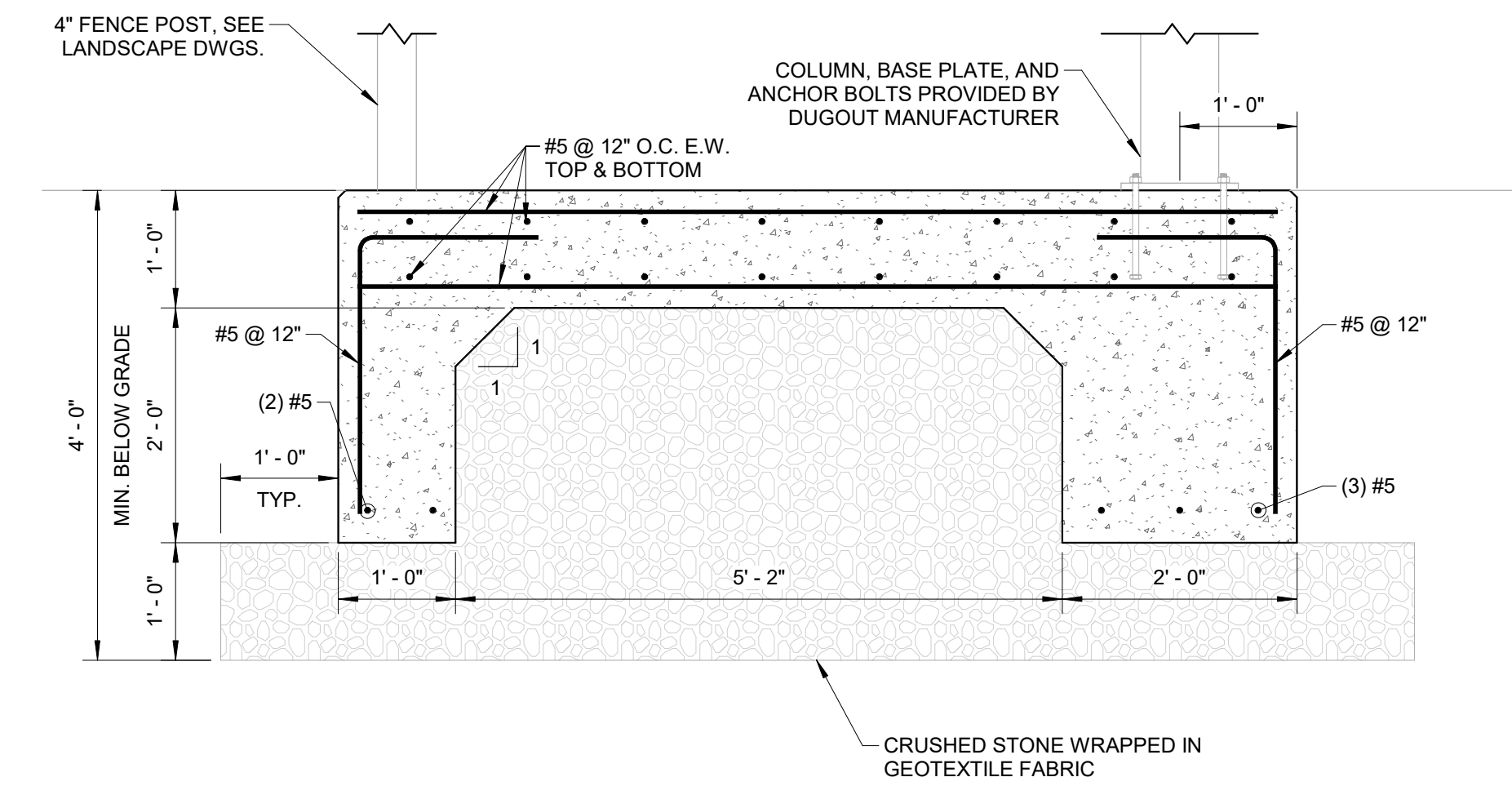

2 SECTION @ DUGOUT FOUNDATION
SCALE: 3/4" = 1'-0"

FOR PERMITTING
NOT FOR CONSTRUCTION



Prepared By:

Weston & Sampson

Consultant Project No. 2160850

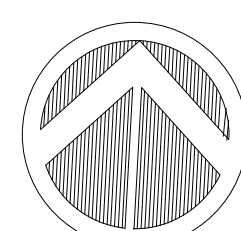

NORTH

No.	Date	Revision

Approved By: _____ Date: _____

Project Name.:

**IMPROVEMENTS TO
McCONNELL PARK**

PERMITTING DOCUMENTS - NOT FOR CONSTRUCTION

Date	FEBRUARY 2021
Scale	
Drawn	AAC
Checked	NMS

Sheet Name.:

ENLARGED FOUNDATION PLANS AND DETAILS II

SHEET:

S5.02

ELECTRICAL LEGEND

RACEWAY AND WIRING

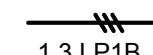
 1,3 LP1B
 HOMERUN TO PANELBOARD. NUMBER OF TICKS INDICATES NUMBER OF #12 AWG CONDUCTORS CONTAINED IN RACEWAY. TWO (2) #12 AWG SHALL NOT BE INDICATED BY TICKS. NUMERALS 1 AND 3 INDICATE CIRCUITS IN PANELBOARD. RACEWAYS LARGER THAN 1/2" AND CONDUCTORS LARGER THAN #12 AWG SHALL BE INDICATED ON THE DRAWINGS. PROVIDE AN INSULATED GREEN GROUND WIRE IN ALL RACEWAYS MINIMUM SIZE TO BE #12AWG.

 CONDUIT/WIRE RUN OVERHEAD

 POWER CONDUIT/WIRE RUN UNDERGROUND

LIGHTING FIXTURES

 SPORTS LIGHTING FIXTURE

 PEDESTRIAN LIGHTING FIXTURE

RECEPTACLES

(MOUNT 18" AFF TO CENTER LINE UNLESS NOTED OTHERWISE)

 DUPLEX CONVENIENCE OUTLET RATED 20A, 125V, U-SLOT GROUNDED TYPE MOUNTED 18" ABOVE FINISHED FLOOR TO CENTER LINE. ALL OTHER MOUNTING HEIGHTS SHALL BE AS NOTED ADJACENT TO THE SYMBOL. REFER TO RECEPTACLE ABBREVIATIONS FOR SPECIAL PURPOSE RECEPTACLES.

MISCELLANEOUS POWER

 JUNCTION BOX WITH BLANK COVERPLATE, SIZE AS REQUIRED BY N.E.C.

 LIGHTING POWER HANDHOLE (COVER SHALL BE LABELED "LIGHTING")

 COMMUNICATION HANDHOLE (COVER SHALL BE LABELED "COMM")

 SURGE SUPPRESSION UNIT

SECURITY EQUIPMENT

 WI-FI CAMERA FURNISHED AND INSTALLED BY OWNER. ELECTRICAL CONTRACTOR TO PROVIDE DOUBLE GANG BOX. PROVIDE 1" C, 2#10 & #10GND FOR POWER

ABBREVIATIONS

AFF	ABOVE FINISHED FLOOR
AC	ALTERNATING CURRENT
A	AMPERE
AF	AMP FUSE
AS	AMP SWITCH
BKR	BREAKER
C	CONDUIT
CKT	CIRCUIT
CB	CIRCUIT BREAKER
EC	ELECTRICAL CONTRACTOR
EMT	ELECTRIC METALLIC TUBING
EWC	ELECTRIC WATER COOLER
EWH	ELECTRIC WATER HEATER
EF	EXHAUST FAN
FL	FLOOR
FLA	FULL LOAD AMPERE
GC	GENERAL CONTRACTOR
GFI	GROUND FAULT INTERRUPTER
GND	GROUND
HOA	HAND OFF AUTOMATIC
HP	HORSEPOWER
IG	ISOLATED GROUND
JB	JUNCTION BOX
KVA	KILOVOLT AMPERES
KW	KILOWATT
MCB	MAIN CIRCUIT BREAKER
MLO	MAIN LUGS ONLY
MC	MECHANICAL CONTRACTOR
MTD	MOUNTED
MTG	MOUNTING
NMC	NON-METALLIC CONDUIT
NC	NORMALLY CLOSED
NO	NORMALLY OPEN
NA	NOT APPLICABLE
NIC	NOT IN CONTRACT
NTS	NOT TO SCALE
PNL	PANELBOARD
PH	PHASE
PVC	POLYVINYL CHLORIDE CONDUIT
RSC	RIGID GALVANIZED STEEL CONDUIT
SF	SUPPLY FAN
SS	SAFETY SWITCH
TEL	TELEPHONE
TRF	TRANSFORMER
V	VOLTS
W	WATTS OR WIRE
WP	WEATHERPROOF
4WSN	4-WIRE SOLID NEUTRAL

RECEPTACLE ABBREVIATIONS

GFI	GROUND FAULT CIRCUIT INTERRUPTER, PERSONAL PROTECTION
WP	WEATHERPROOF RECEPTACLE WITH COVERPLATE LISTED FOR WET LOCATION WITH AN ATTACHMENT PLUG INSERTED.

GENERAL NOTES

- DRAWINGS ARE DIAGRAMMATIC ONLY. THE EXACT LOCATION, MOUNTING HEIGHTS, SIZE OF EQUIPMENT AND ROUTING OF RACEWAYS SHALL BE COORDINATED AND DETERMINED IN THE FIELD.
- ALL STRAIGHT FEEDER, BRANCH CIRCUIT AND AUXILIARY SYSTEM CONDUIT RUNS SHALL BE PROVIDED WITH SUFFICIENT PULL BOXES TO LIMIT THE MAXIMUM LENGTH OF ANY SINGLE CABLE PULL TO 150 FEET. EXACT SIZES OF PULL BOXES AND LOCATIONS TO BE DETERMINED IN THE FIELD BY THE ELECTRICAL CONTRACTOR.
- THE ELECTRICAL CONTRACTOR SHALL COORDINATE WITH THE GENERAL CONTRACTOR AS TO THE EXACT LOCATION OF THEIR RESPECTIVE EQUIPMENT; THE POWER WIRING, CONTROL WIRING AND ALL ELECTRICAL CONNECTIONS AND CONDUIT TURN-UPS SHALL BE COORDINATED WITH THE RESPECTIVE CONTRACTORS BEFORE THE START OF CONSTRUCTION IN THE FIELD.
- WORK SHALL CONFORM TO THE MASSACHUSETTS ELECTRICAL CODE, MASSACHUSETTS BUILDING CODE, NFPA AND REQUIREMENTS OF LOCAL AUTHORITIES HAVING JURISDICTION.
- THE WORD "CONTRACTOR" AS USED IN THE "ELECTRICAL WORK" SHALL MEAN THE ELECTRICAL SUBCONTRACTOR.
- CONTRACTOR SHALL PAY FOR ALL PERMITS, INSURANCE AND TESTS, AND SHALL PROVIDE LABOR AND MATERIAL TO COMPLETE THE ELECTRICAL WORK SHOWN.
- CONTRACTOR SHALL PROVIDE ALL REQUIRED COORDINATION WITH THE ELECTRIC UTILITY.
- ELECTRIC UTILITY WORK ORDER NUMBER FOR THIS PROJECT IS #?????. UTILITY CONTACT PERSON FOR THIS PROJECT IS PAM REILLY SPALL
- EXCEPT AS OTHERWISE NOTED, THE ELECTRICAL WORK SHALL INCLUDE DEMOLITION, PANELBOARDS, CIRCUIT BREAKERS, FEEDERS, WIRING, RACEWAYS, LIGHTING FIXTURES, DEVICES, TELEPHONE AND DATA OUTLETS, SAFETY SWITCHES, TRANSFORMERS AND CONNECTION NECESSARY TO OPERATE MOTORS AND OTHER EQUIPMENT.
- THE CONTRACTOR SHALL PROVIDE ALL TEMPORARY LIGHTING AND POWER AND THE GENERAL CONTRACTOR SHALL PAY ALL ENERGY CHARGES FOR TEMPORARY POWER AND LIGHTING.
- DURING CONSTRUCTION, THE ELECTRICAL CONTRACTOR SHALL KEEP HIS PORTION OF THE WORK NEAT, CLEAN AND ORDERLY.
- ALL SYSTEMS SHALL BE TESTED FOR SHORT CIRCUIT AND GROUNDS PRIOR TO ENERGIZING AND ANY DEFECTS SHALL BE CORRECTED.
- COMPLETE SHOP DRAWINGS SHALL BE SUBMITTED FOR ELECTRICAL EQUIPMENT. WHERE SPECIFIED ELECTRICAL EQUIPMENT IS SUBSTITUTED, THE ELECTRICAL CONTRACTOR SHALL SUBMIT COMPLETE SPECIFICATIONS ON THE SUBSTITUTE AS WELL AS THE ITEM ORIGINALLY SPECIFIED.
- MATERIALS SHALL BE SPECIFICATION GRADE AND UL LISTED.
- WHERE MATERIAL IS CALLED OUT IN THE LEGEND BY MANUFACTURER, TYPE OR CATALOG NUMBER, SUCH DESIGNATIONS ARE TO ESTABLISH STANDARDS OR DESIRED QUALITY. ACCEPTANCE OR REJECTIONS OF PROPOSED SUBSTITUTIONS SHALL BE SUBJECT TO THE APPROVAL OF THE OWNER.
- WORK SHALL BE COORDINATED WITH THAT OF OTHER TRADES TO ELIMINATE INTERFERENCES.
- ELECTRICAL CONTRACTOR SHALL OBTAIN SHOP DRAWINGS/SPECIFICATIONS OF ALL EQUIPMENT FROM THE GENERAL CONTRACTOR PRIOR TO PURCHASING AND INSTALLING ELECTRICAL EQUIPMENT FOR SAME. NOTIFY ENGINEER OF ANY DISCREPANCIES BETWEEN ACTUAL EQUIPMENT INSTALLED AND CONTRACT DOCUMENTS.
- ELECTRICAL WORK SHALL BE GUARANTEED FOR A PERIOD OF ONE YEAR FROM DATE OF FINAL COMPLETION.
- WORK SHALL BE GROUNDED IN ACCORDANCE WITH CODE REQUIREMENTS. COMPLETE EQUIPMENT (INSULATED GREEN WIRE) GROUNDING SYSTEM SHALL BE INSTALLED.
- WIRE SHALL BE TYPE "THHN-THWN" INSULATED FOR 600 VOLTS, MINIMUM SIZE #12 AWG COPPER UNLESS SPECIFICALLY NOTED OTHERWISE.
 WIRING METHODS:
 a. EXTERIOR UNDERGROUND FEEDERS SHALL BE PVC SCHEDULE 80 FOR DIRECT BURIED AND PVC SCHEDULE 40 FOR CONCRETE ENCASED.
 b. EXTERIOR ABOVE GRADE FEEDERS SHALL BE RGS CONDUIT
- CONNECTORS FOR RIGID CONDUIT SHALL BE MADE WITH THREADED COUPLINGS.
- CONDUIT AND TUBING SHALL BE SUPPORTED ON GALVANIZED WALL BRACKETS. TRAPEZE HANGERS OR PIPE STRAPS SECURED BY MEANS OF TOGGLE BOLTS OR INSERTS IN WOOD CONSTRUCTION.
- BOXES SHALL BE GALVANIZED STEEL AND SHALL BE SIZED TO ACCOMMODATE THE EQUIPMENT OR APPARATUS TO BE INSTALLED. WHERE BOXES OF A STANDARD MAKE ARE NOT AVAILABLE, SPECIAL BOXES SHALL BE MANUFACTURED.
- FUSED OR UNFUSED SAFETY SWITCHES SHALL BE TOTALLY ENCLOSED, HEAVY DUTY TYPE. SWITCHES SHALL HAVE VOLTAGE, HORSEPOWER AND AMPERE RATING SUITABLE FOR THE APPLICATION. PROVIDE NUMBER OF POLES AS REQUIRED. SWITCHES LOCATED EXTERIOR TO THE BUILDING OR IN DAMP/WET LOCATIONS SHALL BE IN A NEMA 3R ENCLOSURE.
- FUSES SHALL BE DUAL ELEMENT, TIME DELAY TYPE, AS MANUFACTURED BY BUSSMAN, RELIANCE OR APPROVED EQUAL.
- WALL PLATES SHALL BE PROVIDED FOR EACH RECEPTACLE. PROVIDE WALL PLATES WITH STAINLESS STEEL FINISH FOR ALL DEVICES IN FINISHED AREAS. FOR DEVICES IN UNFINISHED AREAS, PROVIDE CAST IRON OR ALLOY OF SUITABLE TYPE TO MATCH OUTLET BOXES SPECIFIED.
- DUPLEX RECEPTACLES SHALL BE 2 POLE, 3 WIRE, GROUNDING TYPE 20 AMPERE, 125 VOLT WITH METAL PLASTER EARS. RECEPTACLES SHALL BE NEMA STANDARD CONFIGURATION 5-20R.
- CONDUIT PASSING THROUGH FIRE RATED WALLS AND FLOORS SHALL BE PROVIDED WITH ALL NECESSARY MATERIALS TO ENSURE THAT THE FIRE RATED INTEGRITY IS MAINTAINED.
- FEEDER TAPS WILL NOT BE ALLOWED IN PANELBOARD GUTTERS.
- CONTRACTOR SHALL CHECK EXISTING CONDITIONS TO DETERMINE EXACT EXTENT OF WORK TO BE PERFORMED PRIOR TO BIDDING. DIMENSIONS RELEVANT TO EXISTING WORK SHALL BE VERIFIED IN THE FIELD.
- PROVIDE AS-BUILT "CADD" DRAWINGS AT THE COMPLETION OF THE PROJECT.
- ELECTRICAL CONTRACTOR SHALL LABEL ALL ELECTRICAL DEVICES INCLUDING BUT NOT LIMITED TO RECEPTACLES, TEL/DATA OUTLETS, DISCONNECT SWITCHES, PANELBOARDS, THERMAL MOTOR SWITCHES, CONTROL PANELS, JUNCTION BOXES, ETC.
 a. RECEPTACLES - PANEL NAME AND CIRCUIT DESIGNATION
 b. DISCONNECTS - PANEL NAME, CIRCUIT DESIGNATION AND EQUIPMENT SERVING.
 c. ENCLOSED CIRCUIT BREAKERS - PANEL NAME, CIRCUIT DESIGNATION AND EQUIPMENT SERVING.
 d. CONTROL PANEL - PANEL NAME AND CIRCUIT DESIGNATION
 e. JUNCTION BOXES - PANEL NAME AND CIRCUIT DESIGNATION
- ADDRESS QUESTIONS TO THE ENGINEER IN WRITING BEFORE AWARD OF CONTRACT, OTHERWISE ENGINEER INTERPRETATION OF MEANING AND INTENT OF DRAWINGS SHALL BE FINAL.

DEMOLITION NOTES

- A. THE ELECTRICAL CONTRACTOR WILL WORK IN CONJUNCTION WITH THE GENERAL CONTRACTOR TO DEMOLISH THE EXISTING ELECTRICAL SYSTEM. THE ELECTRICAL CONTRACTOR IS TO DEACTIVATE, DISCONNECT AND REMOVE THOSE SYSTEMS WHICH WILL BE DEMOLISHED. THE ELECTRICAL CONTRACTOR WILL REMOVE AND DISPOSE OF ALL ELECTRICAL SYSTEM MATERIALS INCLUDING DEVICES, FIXTURES, RACEWAYS, CABLE, MOTOR CONTROLS AND APPURTENANCES.
- EXISTING SYSTEMS THAT ARE TO REMAIN AND BE PROTECTED DURING DEMOLITION/CONSTRUCTION INCLUDE:
 A. POWER DISTRIBUTION SYSTEM
 B. EXTERIOR LIGHTING SYSTEM
 C. POWER WIRING
 - SYSTEMS WHICH PASS THROUGH THE AREA BEING DEMOLISHED BUT CONTINUE TO AREAS NOT WITHIN THE DEMOLITION SCOPE ARE TO REMAIN. THE ELECTRICAL CONTRACTOR IS TO IDENTIFY (SPRAY PAINT OR EQUIVALENT) AND PROTECT THOSE SYSTEMS WHICH ARE ACTIVE AND ARE TO REMAIN.
 - ALL CONDUIT AND WIRE WHICH IS NO LONGER IN USE IS TO BE REMOVED. CONDUIT AND WIRE IS TO BE REMOVED BACK TO ITS SOURCE OR NEAREST DEVICE WHICH IS SCHEDULED TO REMAIN.
 - MAKE ANY NECESSARY RE-CIRCUITING, EXTENSIONS OF EXISTING CIRCUITS AND RELOCATIONS REQUIRED TO PROPERLY RE-ENERGIZE REMAINING EXISTING SERVICES OR EQUIPMENT THAT MAY BE INTERFERED WITH BY NEW CONSTRUCTION, REMOVALS OR RELOCATIONS. ALL SHUTDOWNS TO RELOCATE ACTIVE FEEDERS OR BRANCH CIRCUITS WILL BE PERFORMED ON OFF HOURS AS MUTUALLY AGREED TO WITH THE OWNER.
 - PRIOR TO REMOVAL OF EQUIPMENT, CONFIRM THAT FEEDER AND BRANCH CIRCUITS ARE NO LONGER ACTIVE. SHOULD IT BE DISCOVERED THE FEEDER OR BRANCH CIRCUITS ARE ACTIVE, NOTIFY THE ARCHITECT IMMEDIATELY FOR DIRECTION.
 - ELECTRICAL CONTRACTOR IS TO REMOVE ALL LAMPS, BALLASTS AND OTHER ELECTRICAL COMPONENTS CLASSIFIED AS HAZARDOUS MATERIALS. ELECTRICAL CONTRACTOR IS TO OBTAIN THE SERVICES OF A LICENSED HAZARDOUS MATERIALS CONTRACTOR TO DISPOSE OF THE MATERIALS. PROVIDE WRITTEN DOCUMENTATION TO THE OWNER'S REPRESENTATIVE FROM THE HAZARDOUS MATERIALS CONTRACTOR.
 - ELECTRICAL DEMOLITION ABBREVIATIONS:
 "EX" DENOTES EXISTING EQUIPMENT TO REMAIN
 "RL" DENOTES EXISTING EQUIPMENT TO BE DISCONNECTED AND RELOCATED. ALL EXISTING CONDUIT AND WIRE SHALL BE REMOVED BACK TO ITS SOURCE AND ALL DEVICES ASSOCIATED WITH THE EQUIPMENT SHALL BE REMOVED OR ALL CONDUIT AND WIRE SHALL BE INTERCEPTED AND EXTENDED AS REQUIRED. ALL NEW CONDUIT AND WIRE SHALL MATCH EXISTING IN STYLE AND SIZE. ALL EXISTING ELECTRICAL DEVICES ASSOCIATED WITH THE EXISTING EQUIPMENT SHALL BE REMOVED AND NEW DEVICES AS SHOWN SHALL BE PROVIDED.
 "NL" DENOTES NEW LOCATION OF RELOCATED EXISTING EQUIPMENT.
 "RE" DENOTES EXISTING EQUIPMENT TO BE DISCONNECTED AND REMOVED ALL EXISTING CONDUIT AND WIRE SHALL BE REMOVED BACK TO ITS SOURCE AND ALL DEVICES ASSOCIATED WITH THE EQUIPMENT SHALL BE REMOVED. EQUIPMENT TO BE DELIVERED TO THE OWNER



Prepared By:

Weston & Sampson



NORTH

No.	Date	Revision

Approved By: RFM Date:

Project Name.:

**IMPROVEMENTS TO
McCONNELL PARK**

NOTICE OF INTENT - NOT FOR CONSTRUCTION -	
Date	FEBRUARY 2021
Scale	
Drawn	MK
Checked	DNM

Sheet Name.:

**ELECTRICAL LEGEND,
ABBREVIATIONS AND
GENERAL NOTES**

SHEET:

E0.01

Consultant Project No. 2160850

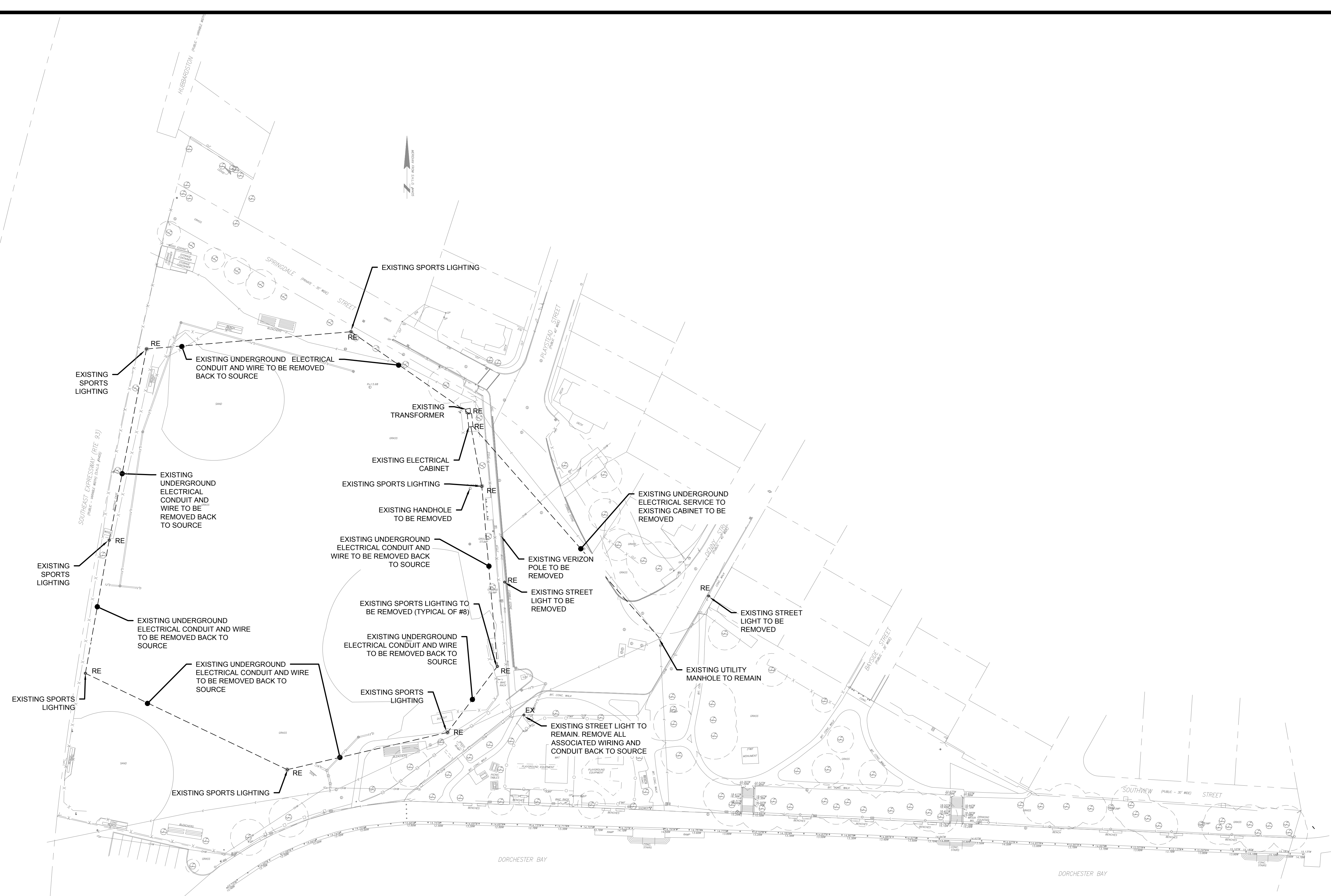

1 ELECTRICAL DEMOLITION SITE PLAN
 SCALE: 1" = 50'-0"
 SCALE: 1" = 50'

DRAWING NOTES:
 1. REFER TO DRAWING E0.01 FOR LEGEND, ABBREVIATIONS, GENERAL NOTES.



Prepared By:
Weston & Sampson
 Consultant Project No. 2160850



No.	Date	Revision

Approved By: RFM Date: _____

Project Name.:
**IMPROVEMENTS TO
 McCONNELL PARK**

NOTICE OF INTENT
 - NOT FOR CONSTRUCTION -

Date	FEBRUARY 2021
Scale	AS NOTED
Drawn	MK
Checked	DNM

Sheet Name.:
**ELECTRICAL SITE
 DEMOLITION PLAN**

SHEET:
E1.00

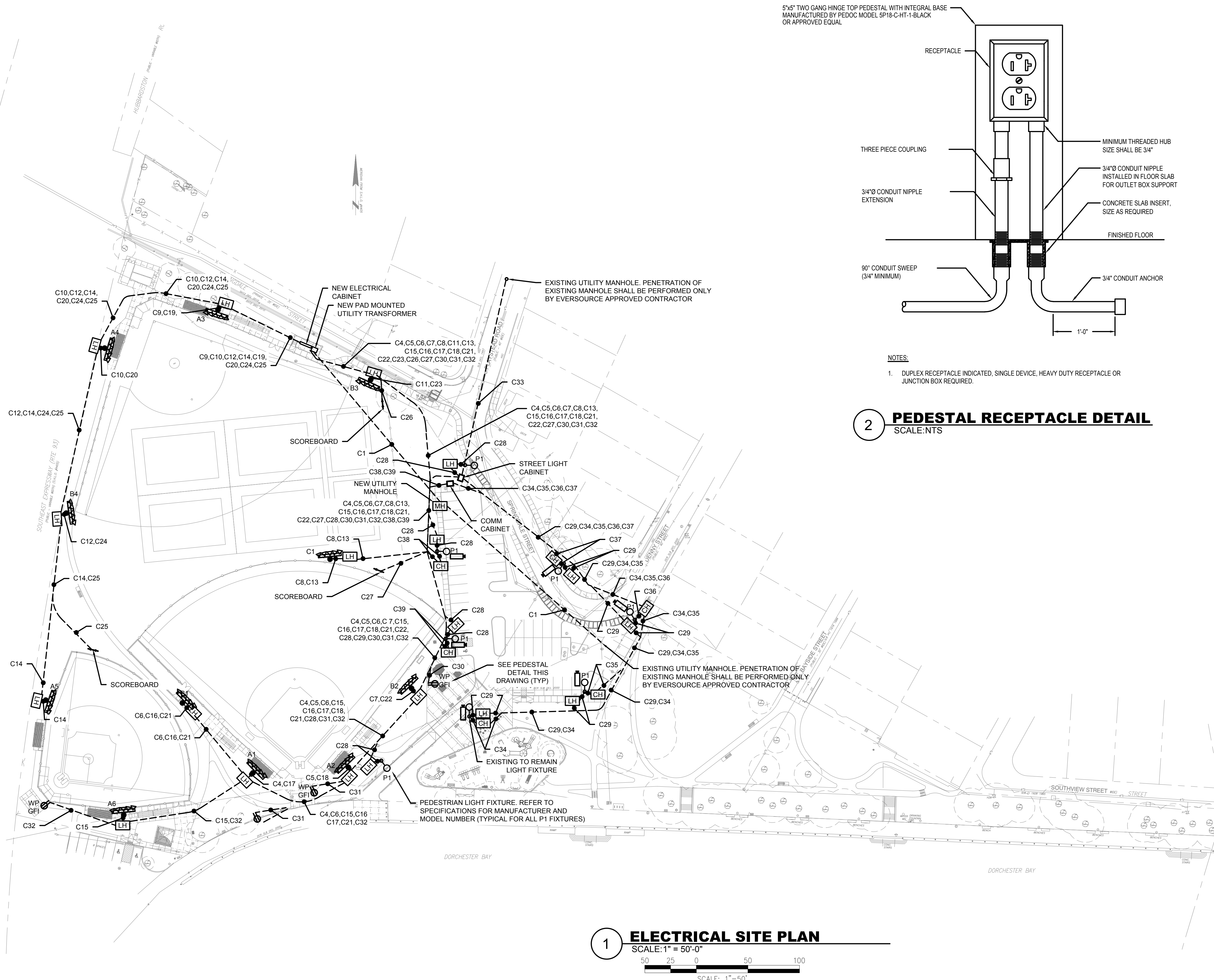

1 ELECTRICAL SITE PLAN
 SCALE: 1" = 50'-0"
 50 25 0 50 100
 SCALE: 1" = 50'

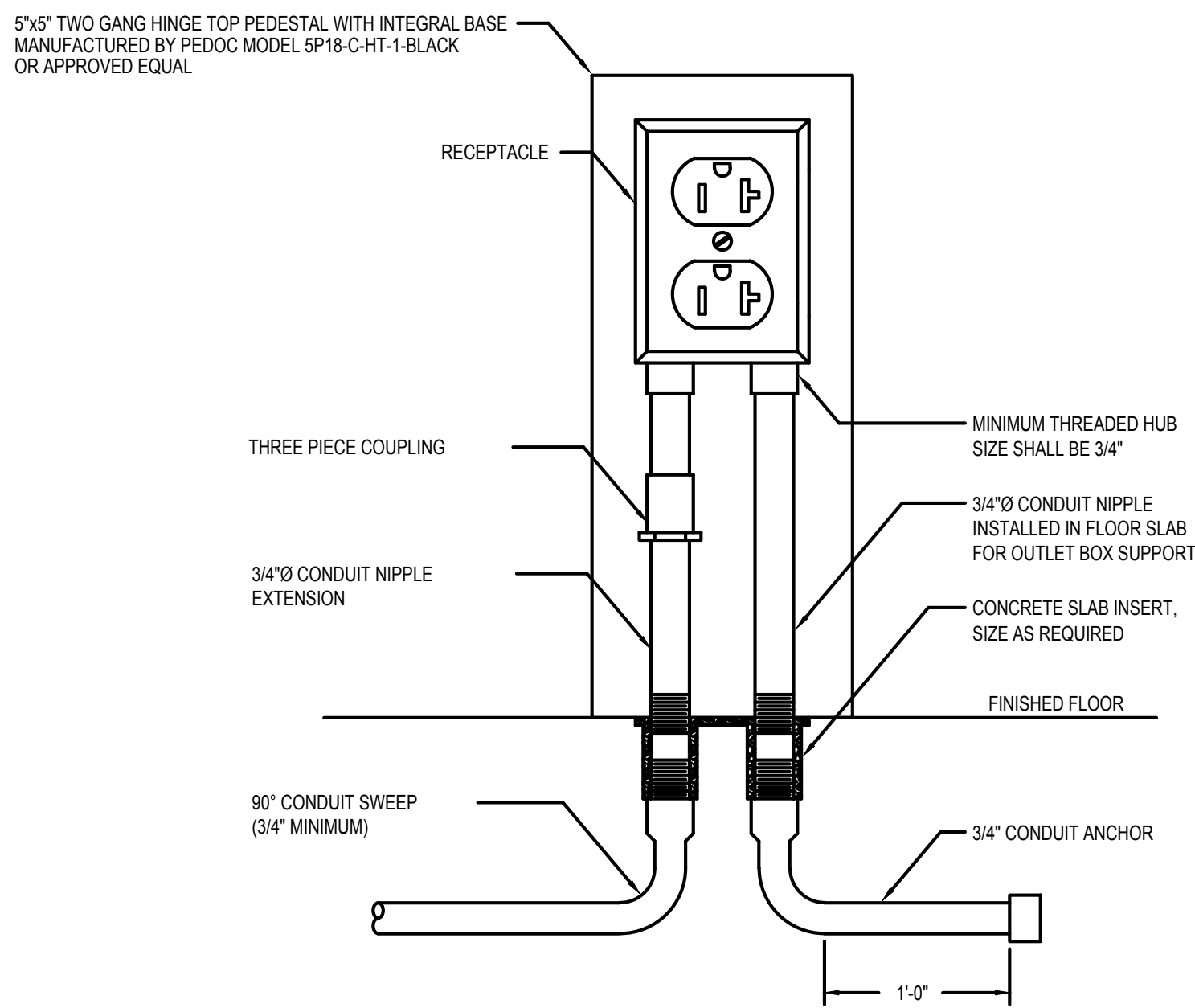

2 PEDESTAL RECEPTACLE DETAIL
 SCALE: NTS

- NOTES:
 1. DUPLEX RECEPTACLE INDICATED, SINGLE DEVICE, HEAVY DUTY RECEPTACLE OR JUNCTION BOX REQUIRED.

CONDUIT AND WIRE SCHEDULE									
CONDUIT TAG	FEEDER	FROM	TO	CONTACT	NO. OF FIXTURES	LOAD	CONTACT SIZE	REMARKS	
C1	2-5"C., WITH NYLON PULL STRING	UTILITY MANHOLE	UTILITY TRANSFORMER	-	-	-	-	CONCRETE ENCASED	
C2	5"C., #450KCMIL & #2GND	UTILITY TRANSFORMER	PPL1 VIA UTILITY METER	-	-	-	-	CONCRETE ENCASED	
C3	5"C., SPARE	UTILITY TRANSFORMER	PPL1 VIA UTILITY METER	-	-	-	-	CONCRETE ENCASED	
C4	1"C, 3#10 & #10GND	PPL1A-1,3,5	POLE A1	C1	3	12.1A	30A	DIRECT BURIED	
C5	1"C, 3#10 & #10GND	PPL1A-2,4,6	POLE A2	C2	3	12.1A	30A	DIRECT BURIED	
C6	1"C, 3#8 & #10GND	PPL1A-7,9,11	POLE B1	C3	4	15.0A	30A	DIRECT BURIED	
C7	1"C, 3#10 & #10GND	PPL1A-8,10,12	POLE B2	C4	4	15.0A	30A	DIRECT BURIED	
C8	1"C, 3#8 & #10GND	PPL1A-13,15,17	POLE C1	C5	7	23.9A	30A	DIRECT BURIED	
C9	1"C, 3#10 & #10GND	PPL1A-14,16,18	POLE A3	C6	4	15.0A	30A	DIRECT BURIED	
C10	1"C, 3#10 & #10GND	PPL1A-20,22,24	POLE A4	C7	4	15.0A	30A	DIRECT BURIED	
C11	1"C, 3#10 & #10GND	PPL1A-26,28,30	POLE B3	C8	6	24.2A	30A	DIRECT BURIED	
C12	1"C, 3#10 & #10GND	PPL1A-27,29,31	POLE B4	C9	7	27.1A	30A	DIRECT BURIED	
C13	1"C, 3#8 & #10GND	PPL1A-33,35,37	POLE C1	C10	8	30.1A	60A	DIRECT BURIED	
C14*	1"C, 3#10 & #10GND	PPL1A-32,34,36	POLE A5	C11	3	12.1A	30A	DIRECT BURIED	
C15*	1"C, 3#8 & #10GND	PPL1A-38,40,42	POLE A6	C12	3	12.1A	30A	DIRECT BURIED	
C16	1"C, 3#8 & #10GND	PPL1B-1,3,5	POLE B1	C13	2	12.1A	30A	DIRECT BURIED	
C17	1"C, 3#10 & #10GND	PPL1B-2,4,6	POLE A1	C14	3	12.1A	30A	DIRECT BURIED	
C18	1"C, 3#10 & #10GND	PPL1B-8,10,12	POLE A2	C15	1	0	30A	DIRECT BURIED	
C19	1"C, 3#10 & #10GND	PPL1B-7,9,11	POLE A3	C16	1	0	30A	DIRECT BURIED	
C20	1"C, 3#10 & #10GND	PPL1B-13,15,17	POLE A4	C17	1	0	30A	DIRECT BURIED	
C21	1"C, 3#10 & #10GND	PPL1B-14,16,18	POLE B1	C18	1	0	30A	DIRECT BURIED	
C22	1"C, 3#10 & #10GND	PPL1B-20,22,24	POLE B2	C19	1	0	30A	DIRECT BURIED	
C23	1"C, 3#10 & #10GND	PPL1B-19,21,23	POLE B3	C20	1	0	30A	DIRECT BURIED	
C24	1"C, 3#10 & #10GND	PPL1B-25,27,29	POLE B4	C21	1	0	30A	DIRECT BURIED	
C25	1"C, 2#10 & #10GND	PPL1B-28	SCOREBOARD	-	1	2.2A	-	DIRECT BURIED	
C26	1"C, 2#12 & #12GND	PPL1B-30	SCOREBOARD	-	2	2.2A	-	DIRECT BURIED	
C27	1"C, 2#12 & #12GND	PPL1B-32	SCOREBOARD	-	3	2.2A	-	DIRECT BURIED	
C28	1"C, 2#12 & #12GND	PPL1B-34	PEDESTRIAN LIGHTING	-	4	2.2A	-	DIRECT BURIED	
C29	1"C, 2#12 & #12GND	PPL1B-34	PEDESTRIAN LIGHTING	-	5	2.2A	-	DIRECT BURIED	
C30	1"C, 2#12 & #12GND	PPL1A-39	RECEPTACLE	-	1	1	-	DIRECT BURIED	
C31	1"C, 2#12 & #12GND	PPL1A-42	RECEPTACLE	-	1	1	-	DIRECT BURIED	
C32*	1"C, 2#12 & #12GND	PPL1B-34	RECEPTACLE	-	1	1	-	DIRECT BURIED	
C33	2-5"C., WITH NYLON PULL STRING	UTILITY MANHOLE	STREET LIGHTING CABINET	-	-	-	-	CONCRETE ENCASED	
C34	1"C., WITH NYLON PULL STRINGS	COMM CABINET	CAMERA	-	-	-	-	DIRECT BURIED	
C35	1"C., WITH NYLON PULL STRINGS	COMM CABINET	CAMERA	-	-	-	-	DIRECT BURIED	
C36	1"C., WITH NYLON PULL STRINGS	COMM CABINET	CAMERA	-	-	-	-	DIRECT BURIED	
C37	1"C., WITH NYLON PULL STRINGS	COMM CABINET	CAMERA	-	-	-	-	DIRECT BURIED	
C38	1"C., WITH NYLON PULL STRINGS	COMM CABINET	CAMERA	-	-	-	-	DIRECT BURIED	

* INDICATES WORK SHALL BE PART OF ADD ALTERNATE #1

- DRAWING NOTES:
 1. REFER TO E0.01 FOR LEGEND, ABBREVIATIONS AND GENERAL NOTES.
 2. REFER TO DRAWING E6.01 FOR PANEL PPL1 SCHEDULE.
 3. REFER TO DRAWING E6.02 FOR PANEL PPL2 SCHEDULE.



Prepared By:
 Weston & Sampson
 Consultant Project No. 2160850



No.	Date	Revision

Approved By: _____ Date: _____

Project Name.:
IMPROVEMENTS TO McCONNELL PARK

NOTICE OF INTENT - NOT FOR CONSTRUCTION -
 Date: FEBRUARY 2021
 Scale: _____
 Drawn: MK
 Checked: DNM

Sheet Name.:
ELECTRICAL SITE NEW WORK PLAN

SHEET:
E1.01

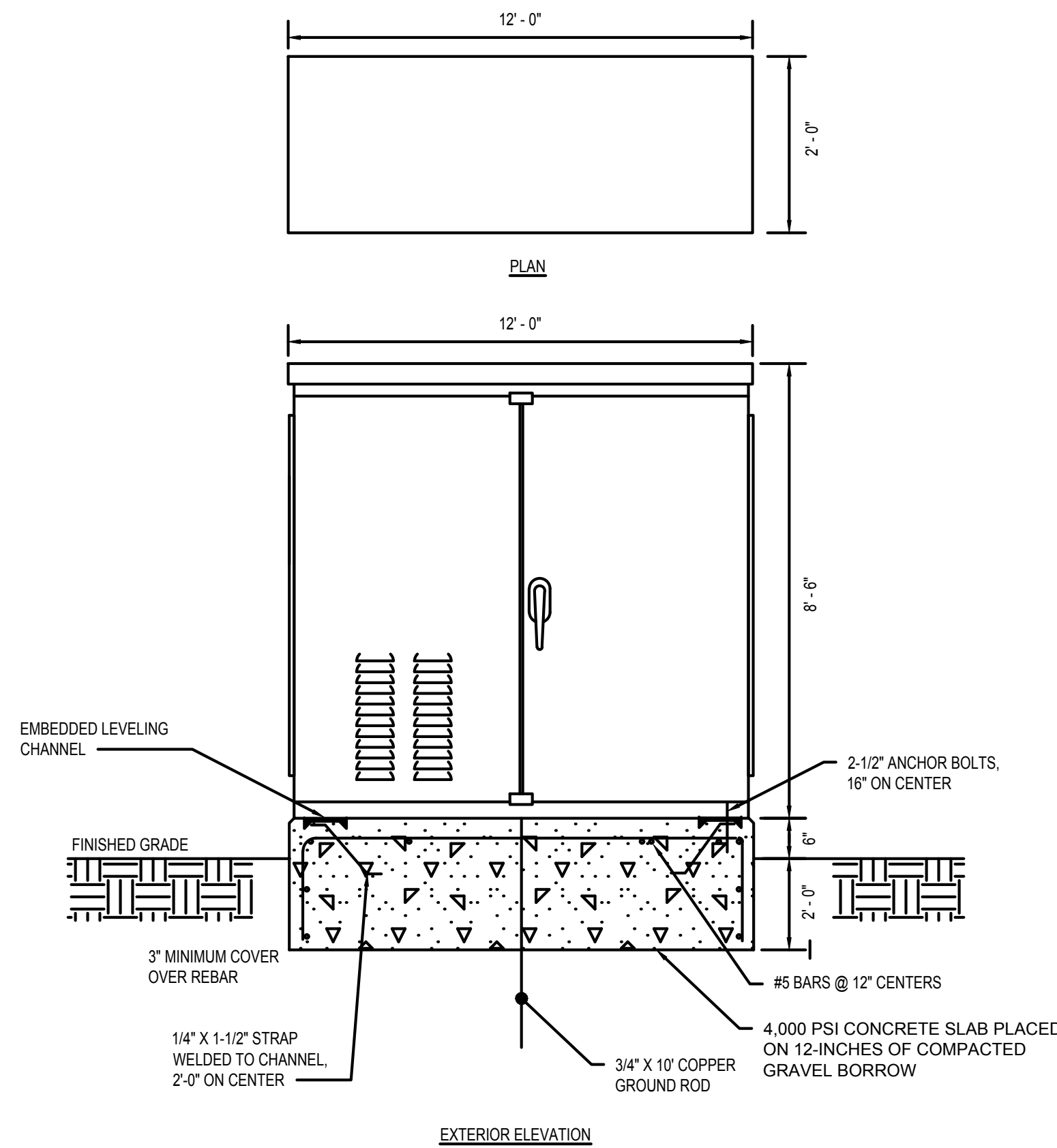

- NOTES:**
1. CONTRACTOR SHALL COORDINATE WITH THE EXACT CABINET SIZE WITH ALL MANUFACTURER EQUIPMENT SIZES PRIOR TO SUBMITTING THE CABINET FOR APPROVAL. PROVIDE A SCALED DRAWING SHOWING ALL EQUIPMENT.

1 PAD MOUNTED NEMA 3R/4X ELECTRICAL CABINET DETAIL
SCALE: NTS

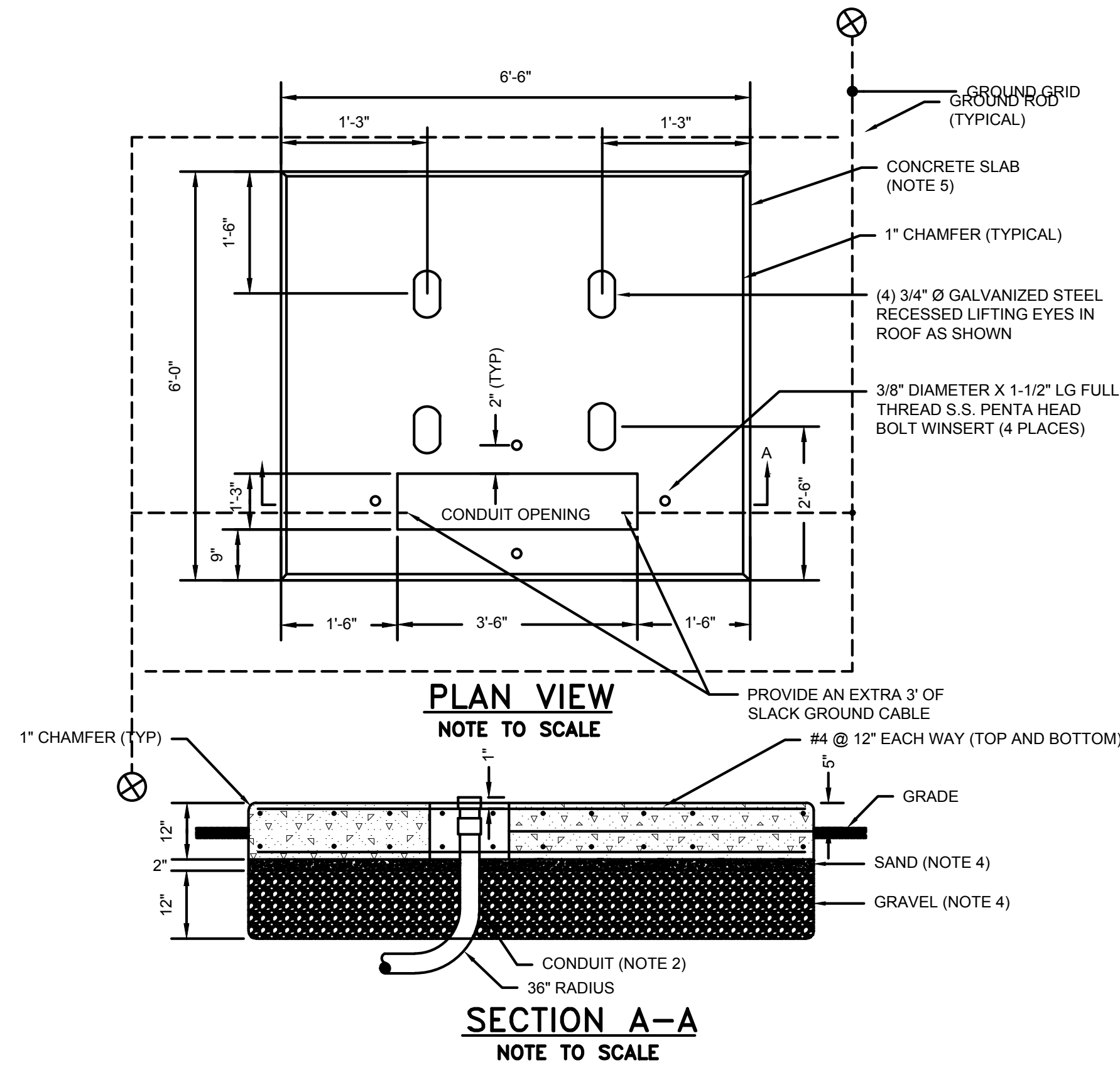

- PADMOUNT - FOUNDATION NOTES:**
1. SCOPE - THIS STANDARD COVERS SPECIFICATIONS FOR THE CONSTRUCTION OF PADMOUNT TRANSFORMER FOUNDATIONS AND GROUNDING FOR EVERSOURCE.
 2. CONDUIT BY ELECTRICAL CONTRACTOR - INSTALL AS SHOWN BEFORE SLAB IS POURED. USE 36" RADIUS BENDS, WITH COUPLINGS, NIPPLES AND BUSHINGS AS REQUIRED. (MATERIAL MAY BE GALVANIZED STEEL, BLACK IRON, OR TYPE II FIBER OR PLASTIC.) TERMINATIONS OF CONDUITS SHALL BE LOCATED EXACTLY AS SHOWN, SOLID OR DOTTED, DEPENDING UPON NUMBER OF DUCTS. THE NIPPLE AND BUSHING SHOULD BE INSTALLED AFTER THE TRANSFORMER IS PLACED AND BEFORE THE CABLES ARE PULLED.
 3. GROUND GRID BY ELECTRICAL CONTRACTOR - INSTALL #10 S.D. 7 STRAND BARE COPPER WIRE LOOP 1'-0" BELOW GRADE. BOND TO ALL EXPOSED METALLIC CONDUIT AND LEAVE 3'-0" OF WIRE ABOVE PAD FOR GROUNDING TRANSFORMER AT TWO OPPOSITE POINTS IN THE CABLE CONDUIT OPENINGS. 3.A. PHOS-COPPER BRAZE CONNECTIONS, CADWELD, OR USE TWO APPROVED CONNECTORS PER JOINT. INSTALL TWO 8 FT. GALVANIZED STEEL (3/4") GROUND RODS WHERE SHOWN. LEAVE GRID EXPOSED UNTIL INSPECTED BY THE UTILITY COMPANY.
 4. GRAVEL & SAND BY GENERAL CONTRACTOR - SHALL BE PLACED AS SHOWN IN FIGS. 1 AND 2. THE GRAVEL BEING COMPACTED AND THE SAND THOROUGHLY WETTED JUST BEFORE PLACING THE CONCRETE.
 5. CONCRETE SLAB BY GENERAL CONTRACTOR - CONCRETE IN ACCORDANCE WITH UTILITY COMPANY REQUIREMENTS. REINFORCE WITH 1/2" RODS LOCATED ON A 12" X 12" GRID AND LOCATED IN THE MIDDLE OF THE SLAB.
 6. THE ELECTRICAL CONTRACTOR SHALL COORDINATE WITH THE UTILITY COMPANY FOR ALL INSTALLATION REQUIREMENTS PRIOR TO THE START OF ANY WORK.
- EVERSOURCE MINIMUM PAD REQUIREMENTS**
1. CONCRETE MINIMUM STRENGTH, 5000 PSI @ 28 DAYS.
 2. STEEL REINFORCEMENT - ASTM A615, GRADE 60.
 3. MINIMUM STEEL COVER, 1-1/2 INCHES.
 4. DESIGN LOADING -- AASHTO HS20-44.
 5. DESIGN SPECIFICATIONS -- ACI 318 & AASHTO LOAD FACTOR DESIGN METHOD.
 6. REINFORCED TO SUPPORT H-20 WHEEL LOAD.
 7. MANUFACTURERS NAME TO BE STENCILED ON VERTICAL WALL OF CUTOFF OPENING.

3 EVERSOURCE PAD MOUNTED TRANSFORMER DETAIL
SCALE: NTS

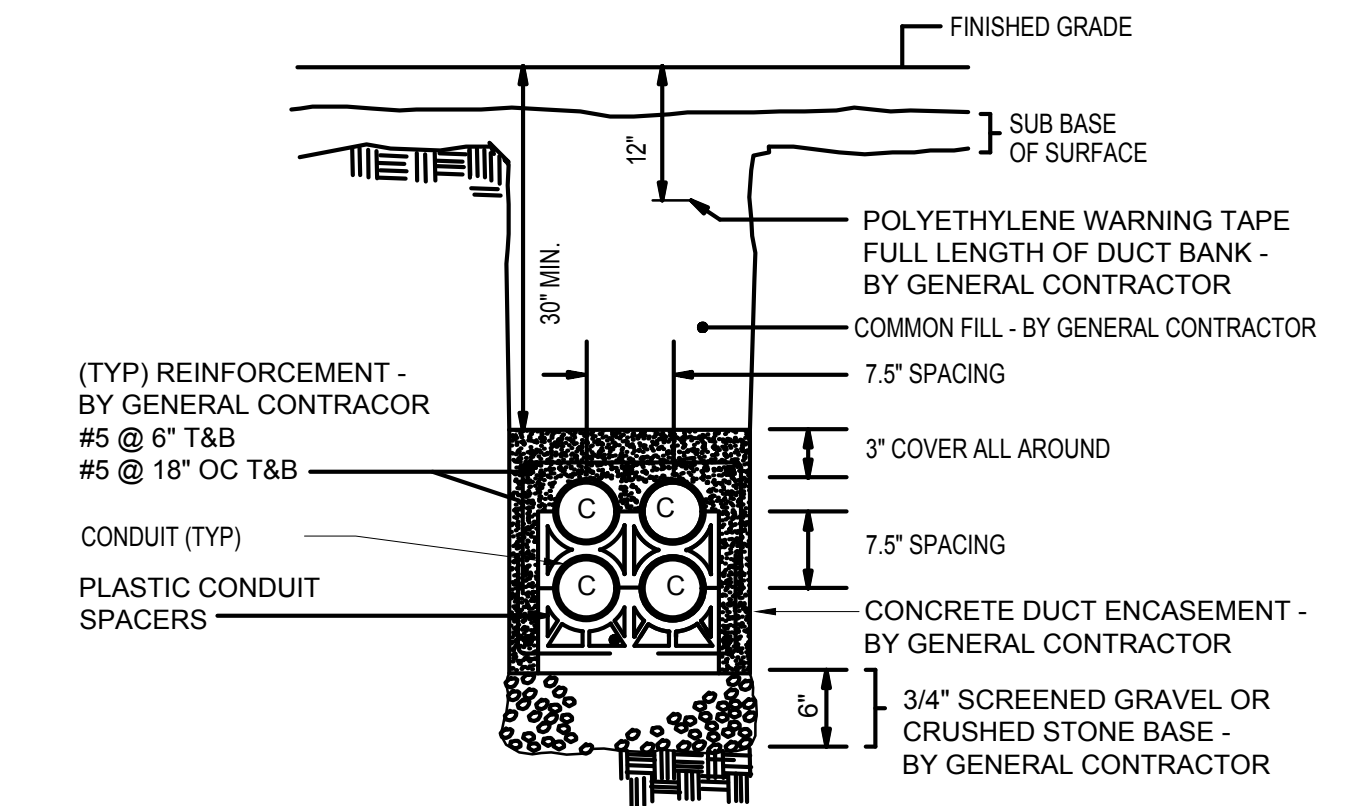

5 TYPICAL 2x2 CONCRETE ENCASED DUCTBANK DETAIL
SCALE: NTS

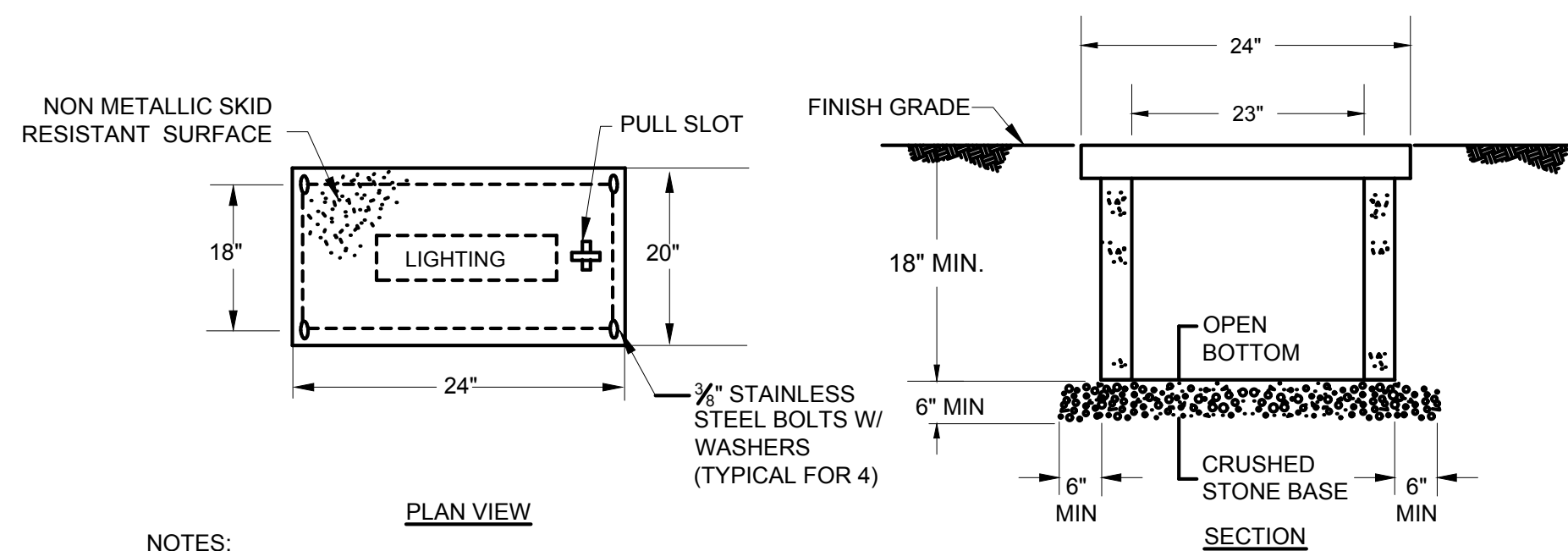

- NOTES:**
1. THIS HANDHOLE IS INTENDED FOR NON-DELIBERATE VEHICULAR TRAFFIC ONLY.
 2. HANDHOLE SHALL BE PREFABRICATED POLYMER CONCRETE AGGREGATE EQUAL TO QUARTZITE OR EQUAL PRE CAST CONCRETE CONSTRUCTION.
 3. HANDHOLE DIMENSION ARE SHOWN FOR REFERENCE ONLY AND SIZE INDICATED IS MINIMUM. EXACT HANDHOLE SIZES SHALL BE BY THE CONTRACTOR.

2 PREFABRICATED HANDHOLE "HH" DETAIL
SCALE: NTS

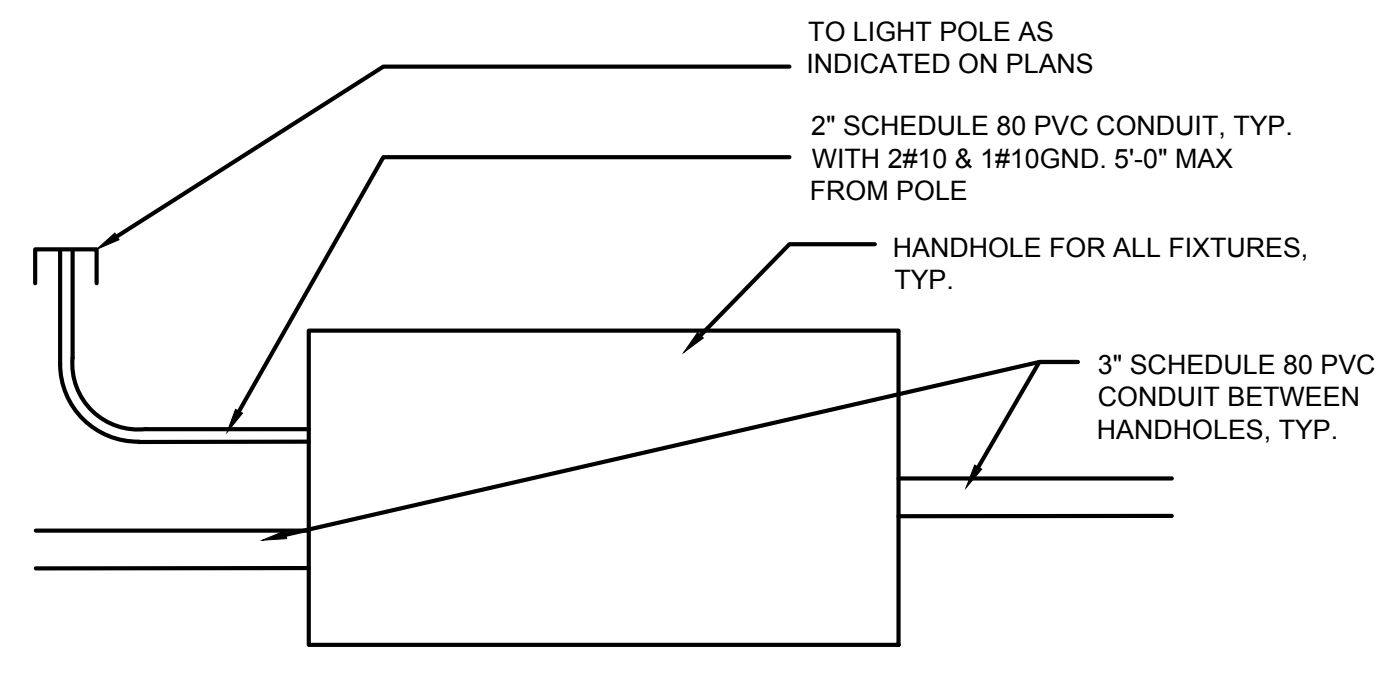

NOTE: ALL HAND HOLES SHALL BE LOCATED IN THE PATHED PATHWAYS

4 TYPICAL PEDESTRIAN SITE LIGHTING DISTRIBUTION
SCALE: NTS

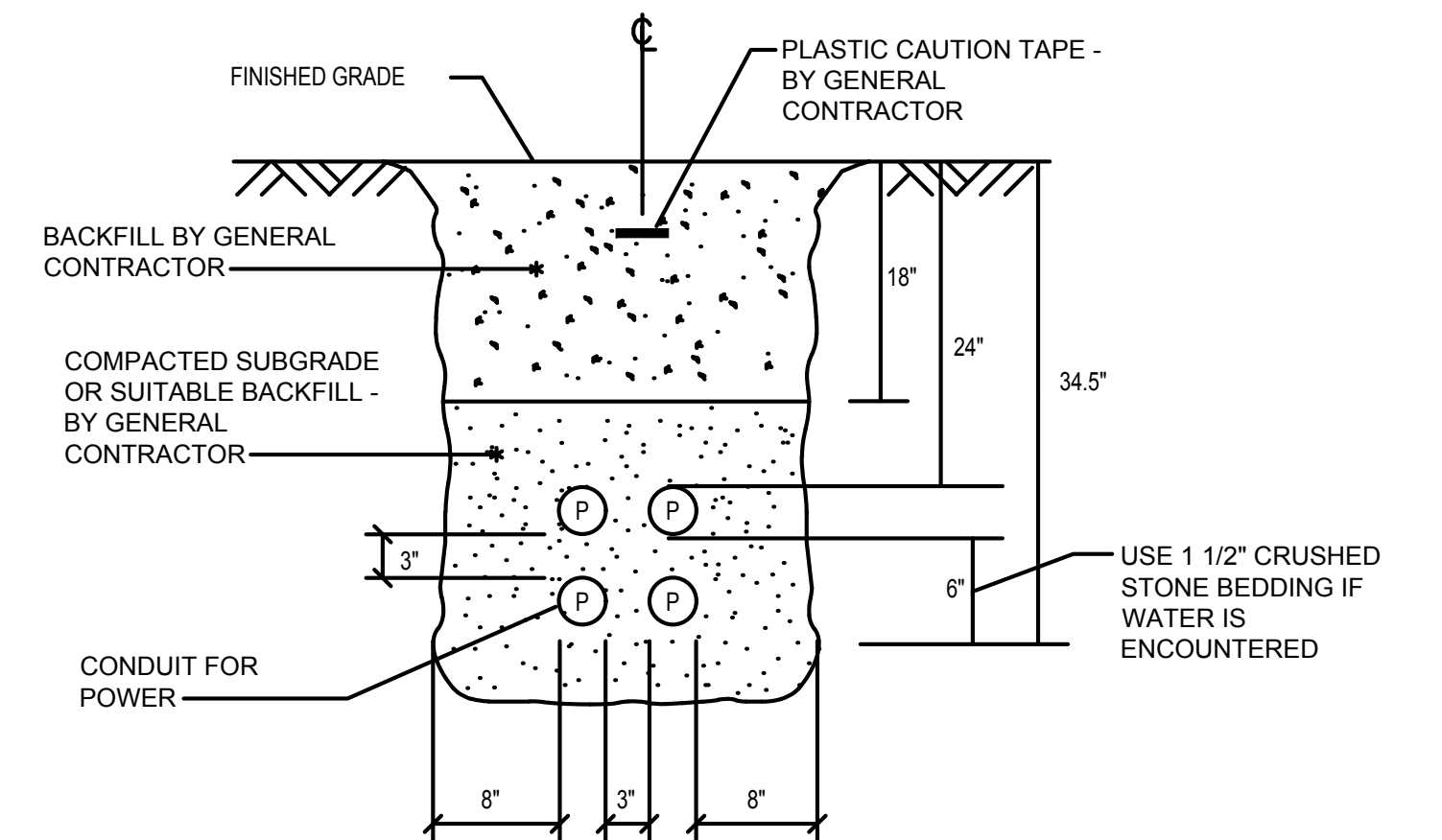

6 TYPICAL DIRECT BURIED MULTIPLE CONDUIT DETAIL
SCALE: NTS



Prepared By:

Weston & Sampson

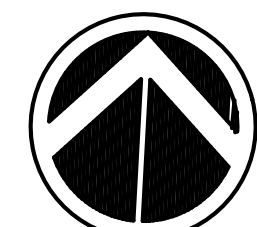

NORTH

No.	Date	Revision

Approved By: RFM Date: _____

Project Name.:

**IMPROVEMENTS TO
McCONNELL PARK**

NOTICE OF INTENT - NOT FOR CONSTRUCTION -	
Date	FEBRUARY 2021
Scale	NTS
Drawn	MK
Checked	DNM

Sheet Name.:

**ELECTRICAL
DETAILS**

SHEET:

E5.01

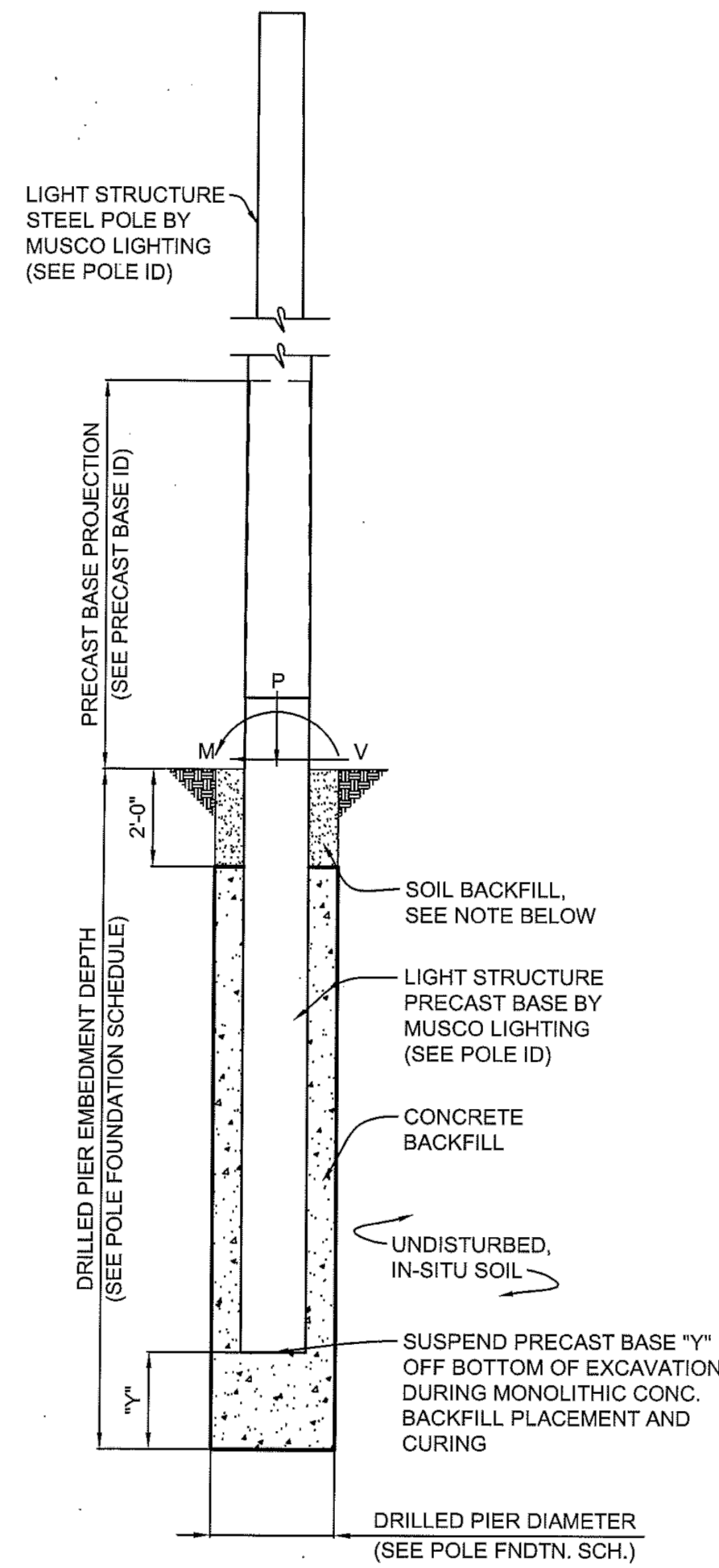

POLE FOUNDATION ELEV.

SCALE: NOT TO SCALE

SOIL BACKFILL NOTE:
THE TOP TWO FEET OF ANNULUS SHALL BE BACKFILLED WITH SOIL, WITH A CLASSIFICATION OF CLASS 5 (TABLE 1806.2) OR BETTER. COMPACTION, 95% FOR COHESIVE SOIL AND 98% FOR A COHESIONLESS SOIL BASED UPON STANDARD PROCTOR TESTING (ASTM D698).

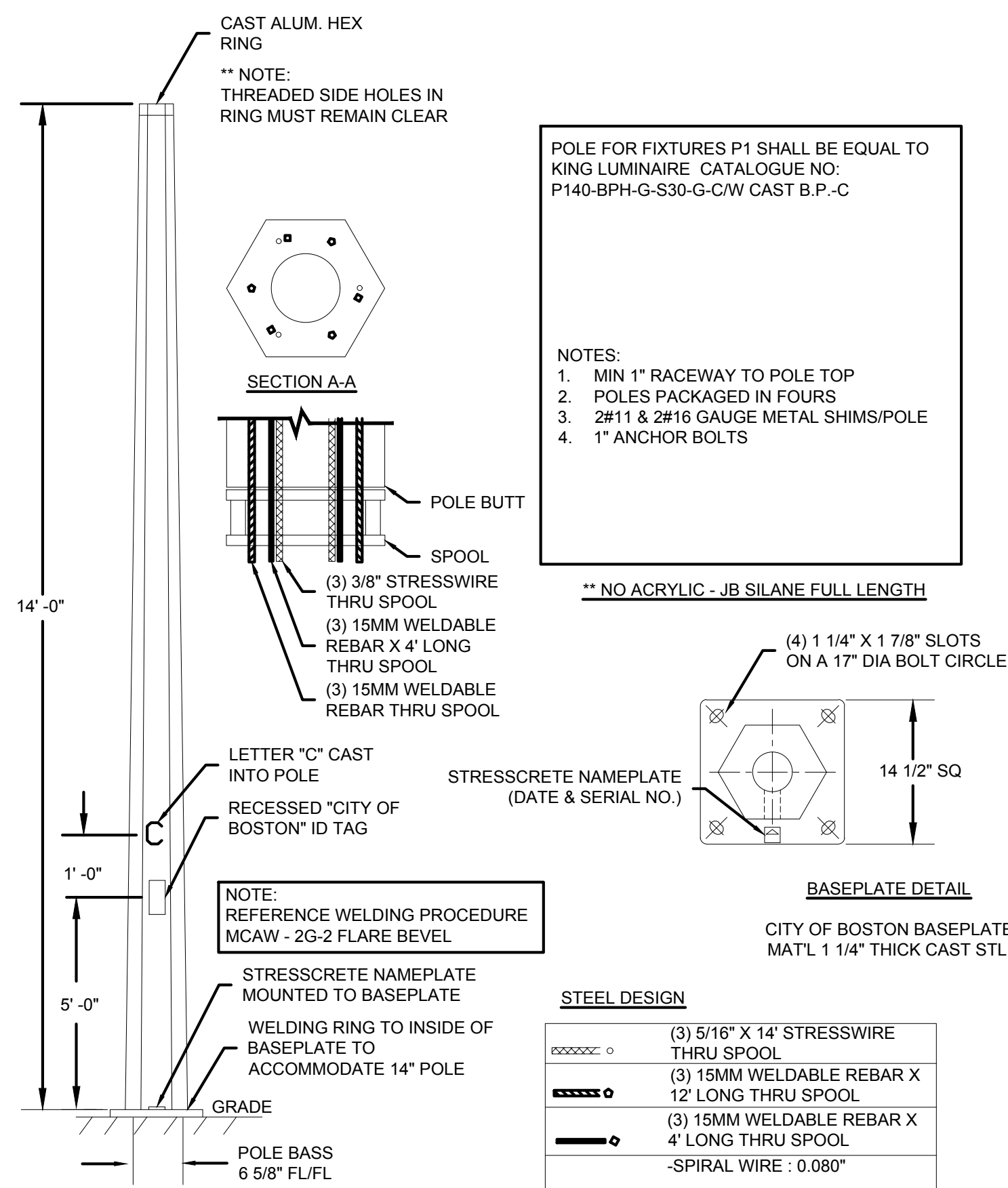

POLE P1 DETAIL

SCALE:NTS

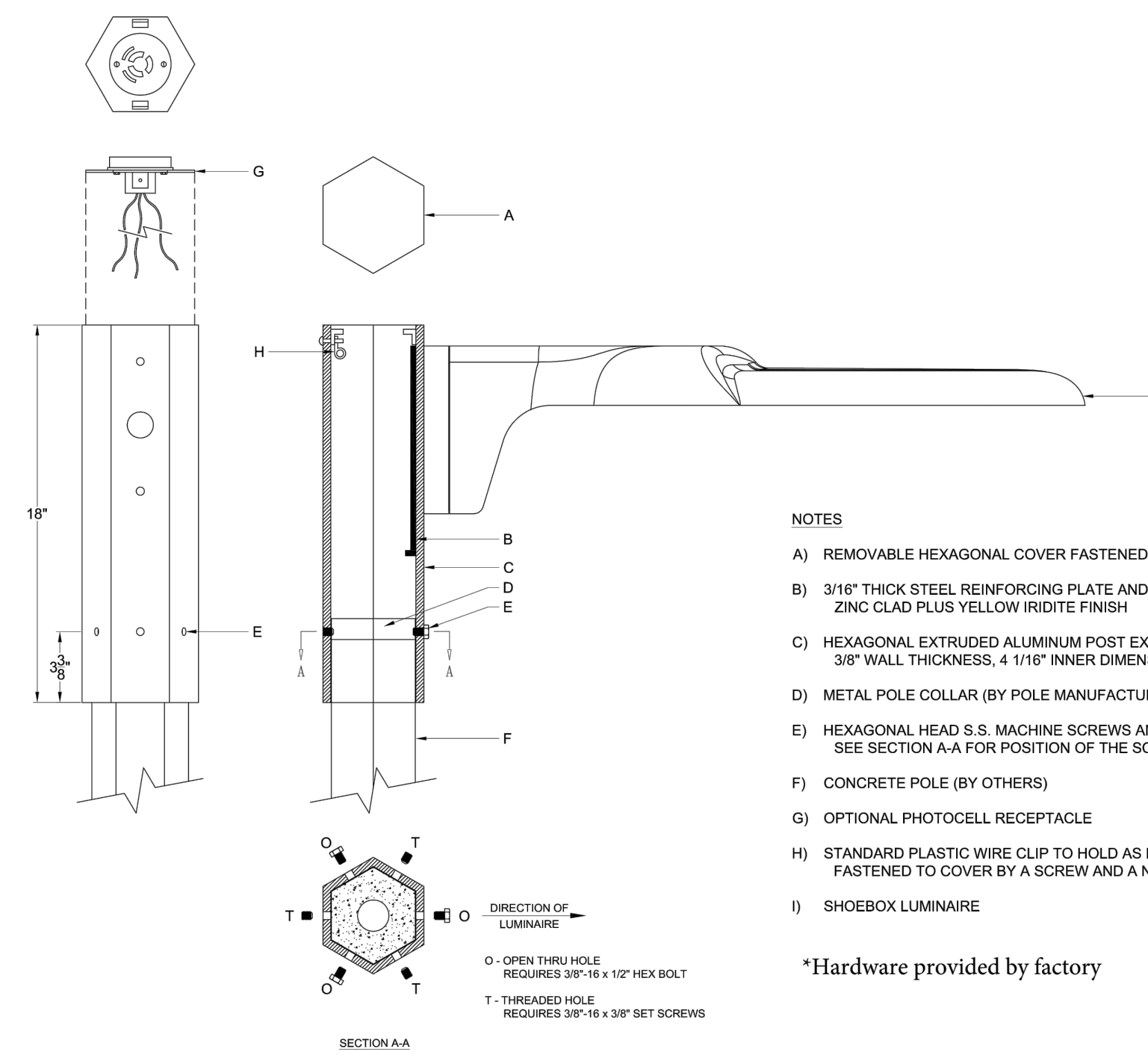

NOTES

- A) REMOVABLE HEXAGONAL COVER FASTENED BY (2) SCREWS
- B) 3/16" THICK STEEL REINFORCING PLATE AND POST STOP, ZINC GLAD PLUS YELLOW IRIDITE FINISH
- C) HEXAGONAL EXTRUDED ALUMINUM POST EXTENSION TO SLIP OVER CONCRETE POLE. 3/8" WALL THICKNESS, 4 1/16" INNER DIMENSION ACROSS FLATS.
- D) METAL POLE COLLAR (BY POLE MANUFACTURER)
- E) HEXAGONAL HEAD S.S. MACHINE SCREWS AND S.S. SET SCREWS. SEE SECTION A-A FOR POSITION OF THE SCREWS.
- F) CONCRETE POLE (BY OTHERS)
- G) OPTIONAL PHOTOCELL RECEPTACLE
- H) STANDARD PLASTIC WIRE CLIP TO HOLD AS MANY AS (3) #10 AWG WIRES, FASTENED TO COVER BY A SCREW AND A NUT.
- I) SHOEBOX LUMINAIRE

*Hardware provided by factory

POLE P1 LUMINAIRE MOUNTING DETAIL

SCALE:NTS

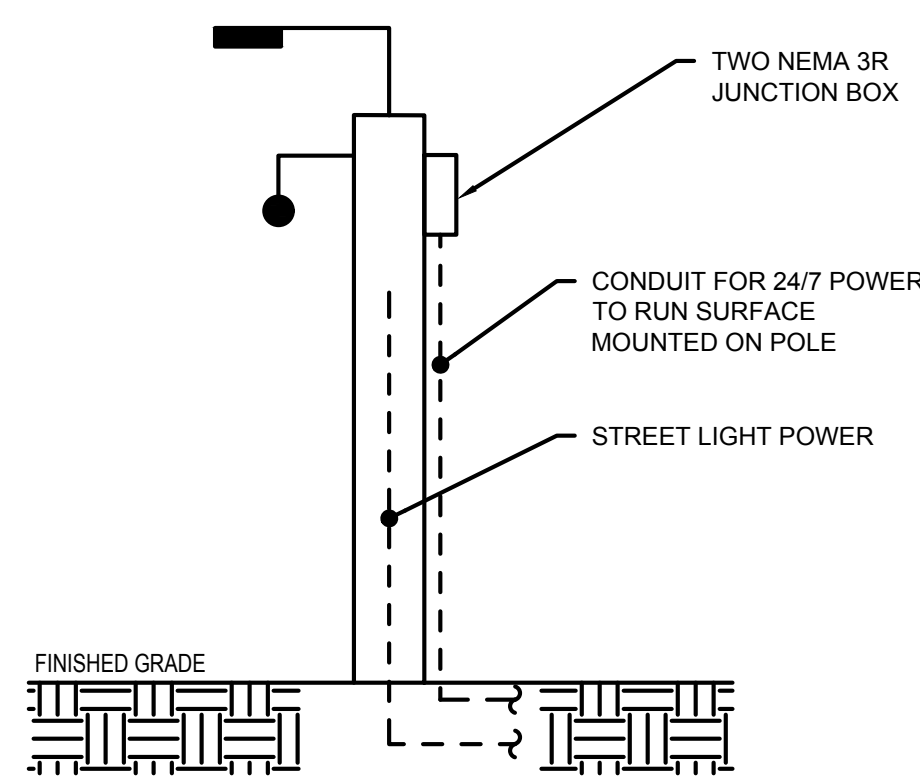

POLE CONDUIT ROUTING DETAIL

SCALE:NTS



Prepared By:



Consultant Project No. 2160850

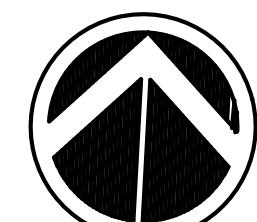

NORTH

No.	Date	Revision

Approved By: RFM Date: _____

Project Name.:

IMPROVEMENTS TO MCCONNELL PARK

NOTICE OF INTENT - NOT FOR CONSTRUCTION -

Date	FEBRUARY 2021
Scale	NTS
Drawn	MK
Checked	DNM

Sheet Name.:

ELECTRICAL DETAILS

SHEET:

E5.02

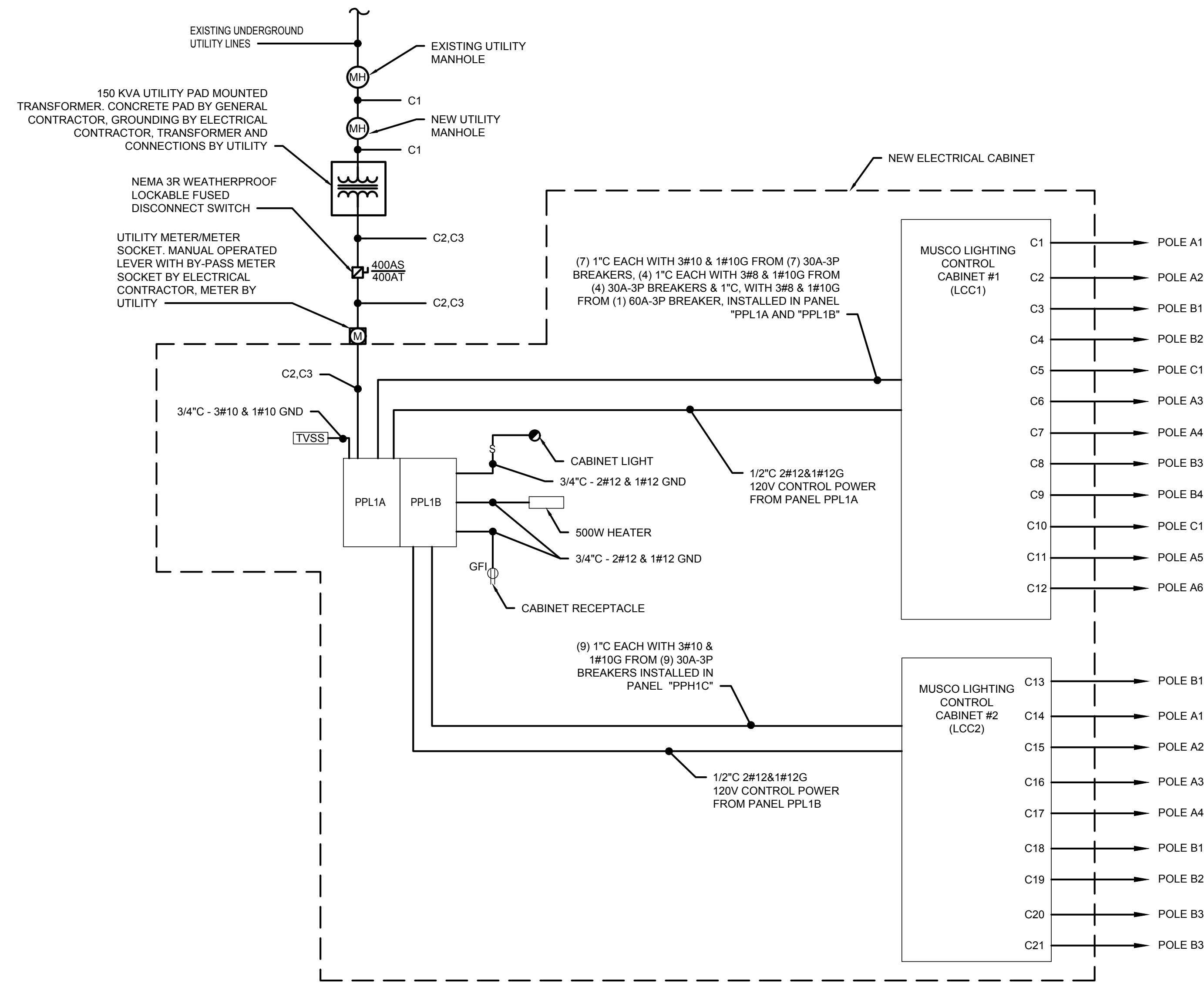

ONE LINE DIAGRAM NOTES:
 1. TYPICAL FOR ALL CONTACTORS, CONTRACTOR SHALL RUN CONDUIT AND WIRING AS INDICATED IN SCHEDULE FROM EACH CONTACTOR TO DESIGNATED LIGHTING POLE. CONTRACTOR SHALL RUN CONDUIT TO 10'-0" AFG FOR CONNECTION TO POLE MOUNTED LIGHTING CONNECTION BOX.

PANELBOARD SCHEDULE										
DESIGNATION: PPL1A (TUB 1)			S.C. RATING: 22,000A RMS SYM.			REMARKS: SERVICE ENTRANCE RATED, PROVIDE WITH FEED THROUGH LUGS				
LOCATION: ELECTRICAL CABINET			SERVICE: 208/120V, 3Ø, 4W							
RATING: 400 AMPS			MOUNTING: SURFACE							
MAIN: 400 MCB										
CKT. NO.	LOAD DESIGNATION	BREAKER TRIP	POLE	PHASE A B C	BREAKER TRIP	LOAD DESIGNATION	CKT. NO.			
1	-	-	-	-	-	-	2			
3	FIXTURE POLE A1/CONTACTOR C1	30	-	-	-	FIXTURE POLE A2/CONTACTOR C2	4			
5	-	-	-	-	-	-	6			
7	-	-	-	-	-	-	8			
9	FIXTURE POLE B1/CONTACTOR C3	30	-	-	-	FIXTURE POLE B2/CONTACTOR C4	10			
11	-	-	-	-	-	-	12			
13	-	-	-	-	-	-	14			
15	FIXTURE POLE C1/CONTACTOR C5	30	-	-	-	FIXTURE POLE A3/CONTACTOR C6	16			
17	-	-	-	-	-	-	18			
19	-	-	-	-	-	-	20			
21	TVSS	30	-	-	-	FIXTURE POLE A4/CONTACTOR C7	22			
23	-	-	-	-	-	-	24			
25	LCC-1 CONROL POWER	20	-	-	-	-	26			
27	-	-	-	-	-	FIXTURE POLE B3/CONTACTOR C8	28			
29	FIXTURE POLE B4/CONTACTOR C9	30	-	-	-	-	30			
31	-	-	-	-	-	FIXTURE POLE A5/CONTACTOR C11	32			
33	-	-	-	-	-	-	34			
35	FIXTURE POLE C1/CONTACTOR C10	60	-	-	-	-	36			
37	-	-	-	-	-	FIXTURE POLE A6/CONTACTOR C12	38			
39	RECEPTACLE	20	-	-	-	-	40			
41	RECEPTACLE	20	-	-	-	-	42			

PANELBOARD SCHEDULE										
DESIGNATION: PPL1B (TUB 2)			S.C. RATING: 22,000A RMS SYM.			REMARKS:				
LOCATION: ELECTRICAL CABINET			SERVICE: 208/120V, 3Ø, 4W							
RATING: 400 AMPS			MOUNTING: SURFACE							
MAIN: 400 MCB										
CKT. NO.	LOAD DESIGNATION	BREAKER TRIP	POLE	PHASE A B C	BREAKER TRIP	LOAD DESIGNATION	CKT. NO.			
1	-	-	-	-	-	-	2			
3	POLE B1/CONTACTOR C13	30	-	-	-	POLE A1/CONTACTOR C14	4			
5	-	-	-	-	-	-	6			
7	-	-	-	-	-	-	8			
9	POLE A3/CONTACTOR C16	30	-	-	-	POLE A2/CONTACTOR C15	10			
11	-	-	-	-	-	-	12			
13	-	-	-	-	-	-	14			
15	POLE A4/CONTACTOR C17	30	-	-	-	POLE B1/CONTACTOR C18	16			
17	-	-	-	-	-	-	18			
19	-	-	-	-	-	-	20			
21	POLE B3/CONTACTOR C20	30	-	-	-	POLE B2/CONTACTOR C19	22			
23	-	-	-	-	-	-	24			
25	-	-	-	-	-	LCC-2 CONTROL POWER	26			
27	POLE B4/CONTACTOR C21	30	-	-	-	SCOREBOARD	28			
29	-	-	-	-	-	SCOREBOARD	30			
31	CABINET LIGHT	20	-	-	-	SCOREBOARD	32			
33	ELECTRIC HEATER IN ELECTRICAL CABINET	20	-	-	-	RECEPTACLE	34			
35	RECEPTACLE CABINET	20	-	-	-	SPARE	36			
37	SPARE	20	-	-	-	SPARE	38			
39	SPARE	20	-	-	-	SPARE	40			
41	SPARE	20	-	-	-	SPARE	42			

DRAWING NOTES:
 1. REFER TO DRAWING E0.01 FOR LEGEND, ABBREVIATIONS AND GENERAL NOTES.
 2. REFER TO DRAWING E1.01 FOR CONDUIT AND WIRE SCHEDULES.

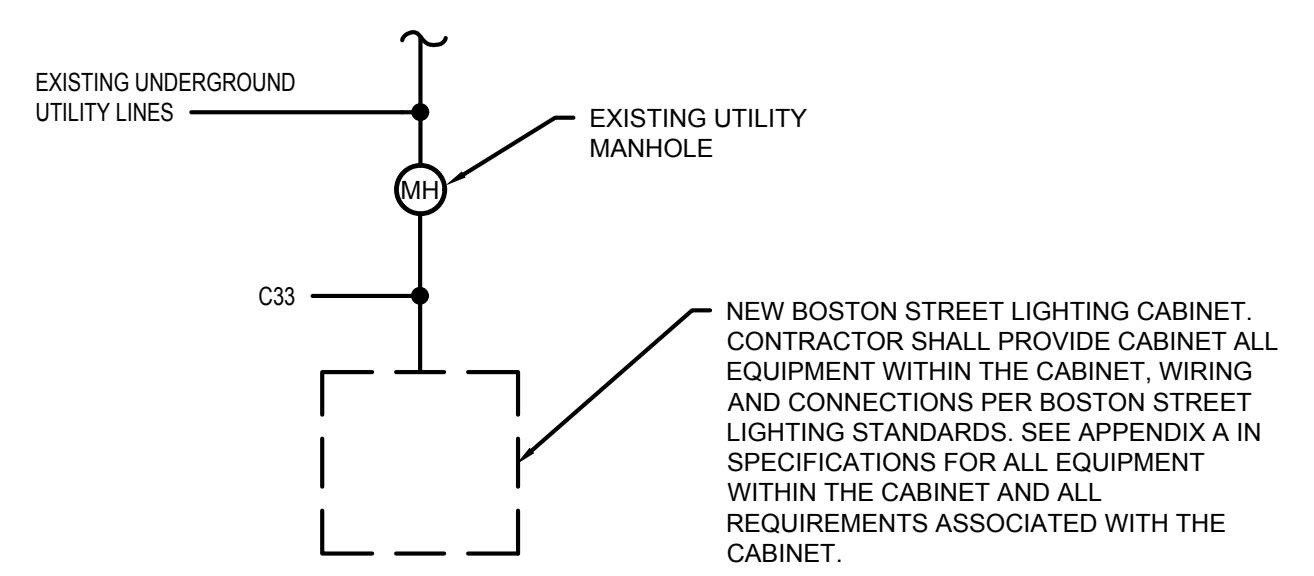

STREET LIGHTING ONE LINE DIAGRAM
 NOT TO SCALE

PARK & REC ONE LINE DIAGRAM
 NOT TO SCALE

LIGHTING FIXTURE SCHEDULE									
TYPE	TYPE	MANUFACTURER	CATALOG NUMBER	LAMP		MOUNTING	VOLTAGE	LOAD	REMARKS
				NO.	TYPE				
P1	ARCHITECTURAL LED AREA LUMINAIRE	LEOTEK	AR18-10M2-MV-NW-3GY-350-HPA-HPF-38WW	1	LED 5400 LUMENS 40K	POLE	120	41W	MOUNT AT 12'-0" AFF.



Prepared By:
 Weston & Sampson
 Consultant Project No. 2160850



No.	Date	Revision

Approved By: _____ Date: _____

Project Name.:
IMPROVEMENTS TO McCONNELL PARK

NOTICE OF INTENT - NOT FOR CONSTRUCTION -
 Date: FEBRUARY 2021
 Scale: _____
 Drawn: MK
 Checked: DNM

Sheet Name.:
ELECTRICAL ONE-LINE AND SCHEDULES

SHEET:
E6.01