

# 60 MASSACHUSETTS AVE BOSTON, MA

Lighting Design

08-26-2021



# Lighting Concept

Highlight  
Architectural Volumes

Let Middle Facade  
Fade to Background

## Electrical Details:

- 120V to drivers + Low Voltage to fixture
- Conduit fed
- Remote drivers at interior locations
- Dimmable
- Zoned for flexibility



# Techniques Implored: Highlighting Volumes



## Grazing with Linears

- Used at Ground level
- 1' + 4' Sections
- Integral Driver

LG2

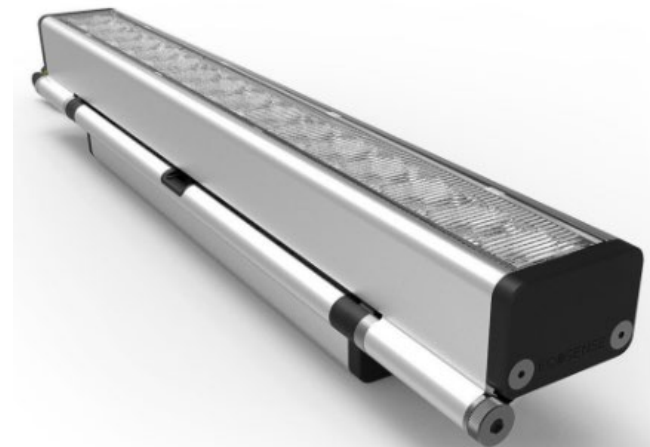

# Techniques Implored: Highlighting Volumes

## Applications

7-FT Wall

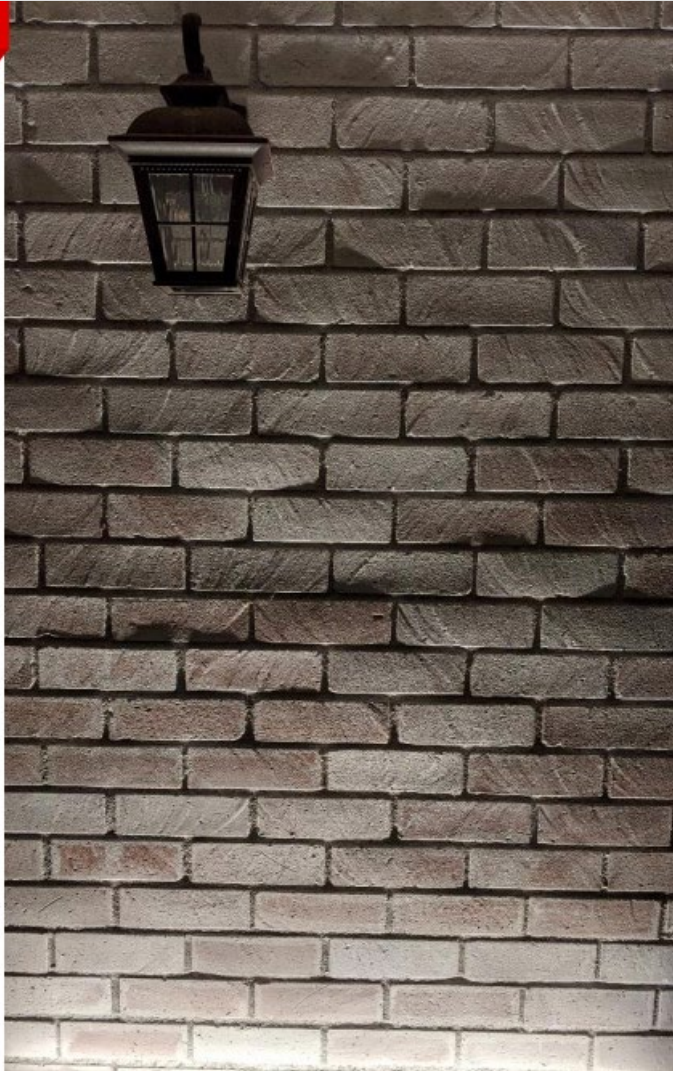

## Grazing with Linears

- Flexible LED Tape with Grazing Optics
- Remote Driver
- Mounting conditions with narrow ledge at 2<sup>nd</sup> + 3<sup>rd</sup> Levels

LS2

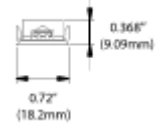

10x10: W .72" x H .36" x L 120" ; (18.40mm x 9.1mm x 3050mm)

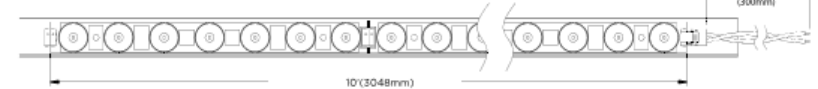

# Techniques Implored: Highlighting Volumes

## LS2 Custom Mounting Detail

- Mounting condition with narrow ledge at 1<sup>st</sup>, 2<sup>nd</sup>, + 3<sup>rd</sup> Levels
- Custom L-bracket to hide fixture from street view with silicon spacer to accommodate for mounting ledge slant

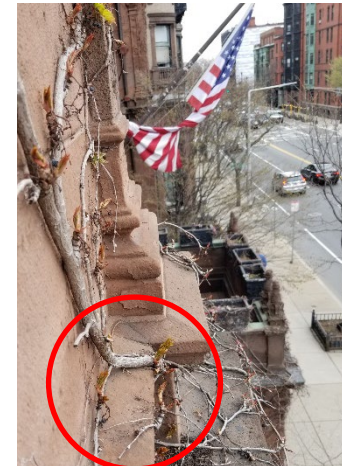
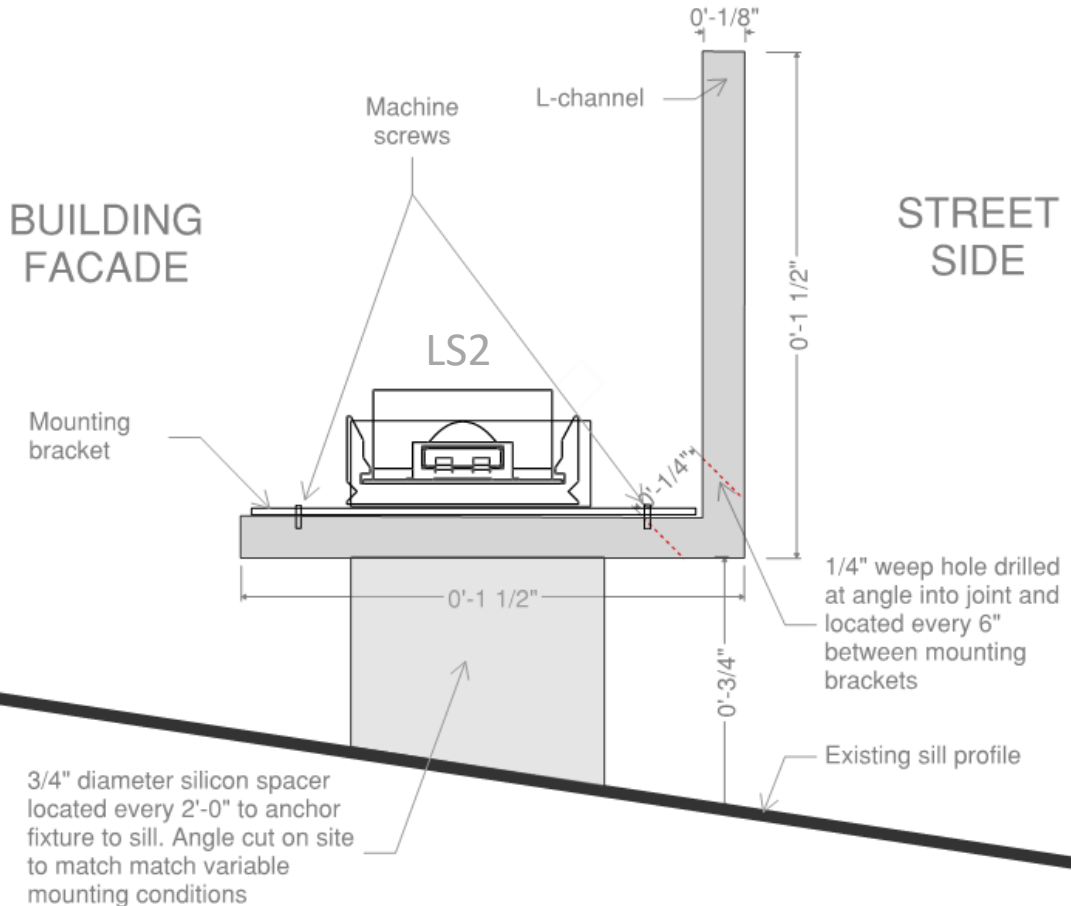

Existing condition

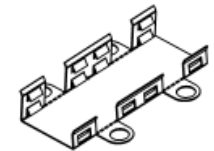
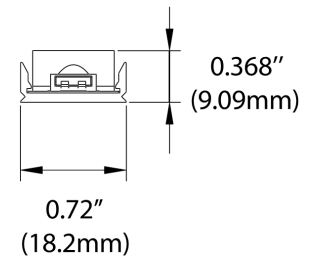

# Techniques Implored: Highlighting Volumes



## Grazing with Pin Spots

- Draw attention to architectural profiles
- Remote Driver

LS1

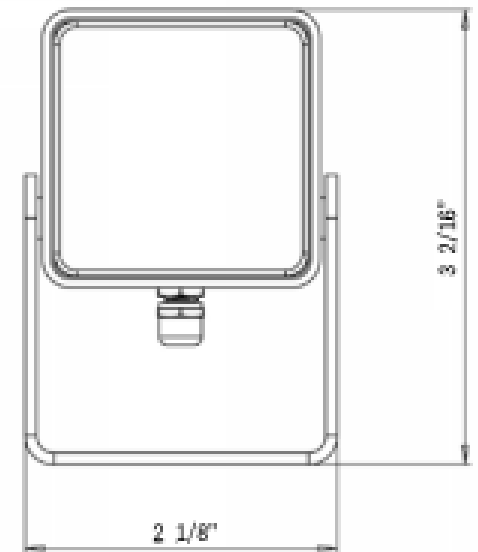

# Techniques Implored: Soft Wash on Central Massing

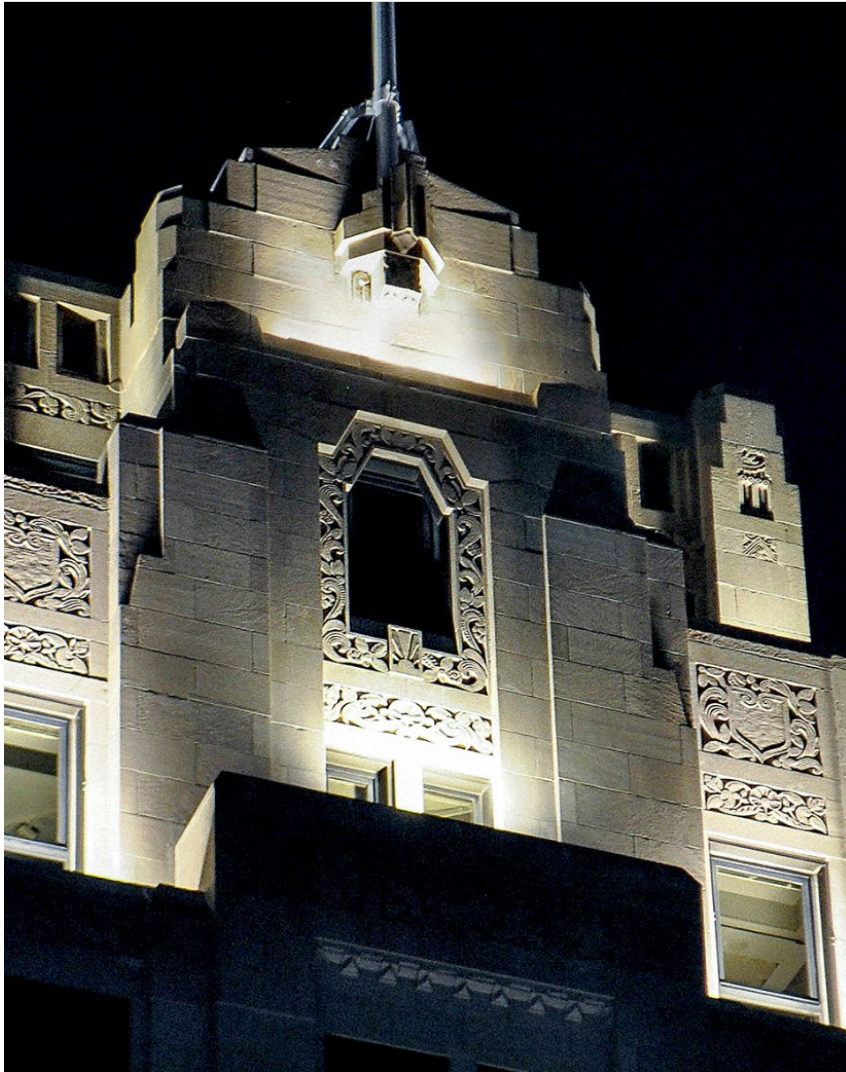

## Up-light with Floods

- 30X60 Elongating Wide-flood Optics
- 2 + 4-head for aiming flexibility
- 120V
- Integral Driver
- Surface mount at building /  
Ground mount at garden level

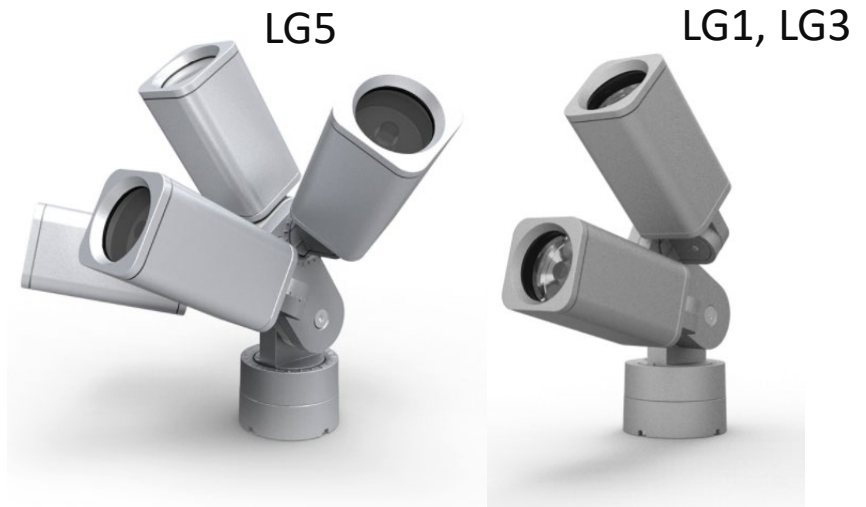

# Ground Level

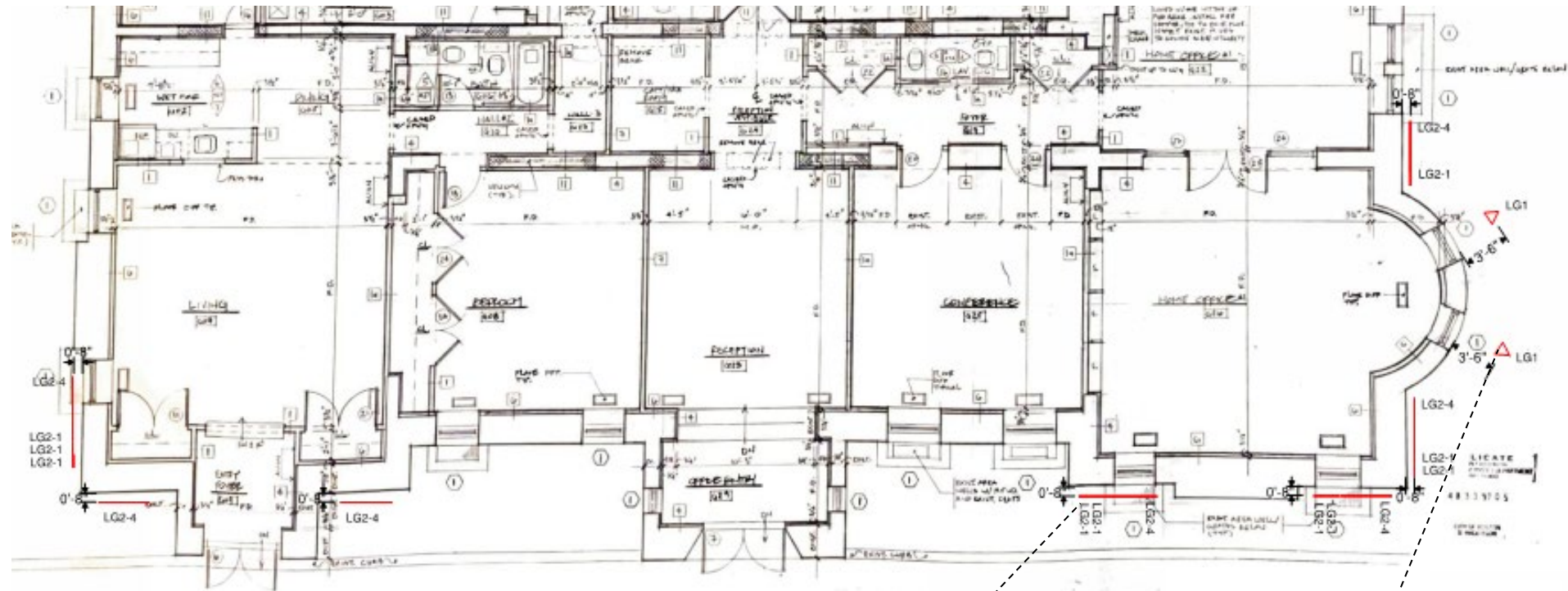

**Legend:**





# First Level

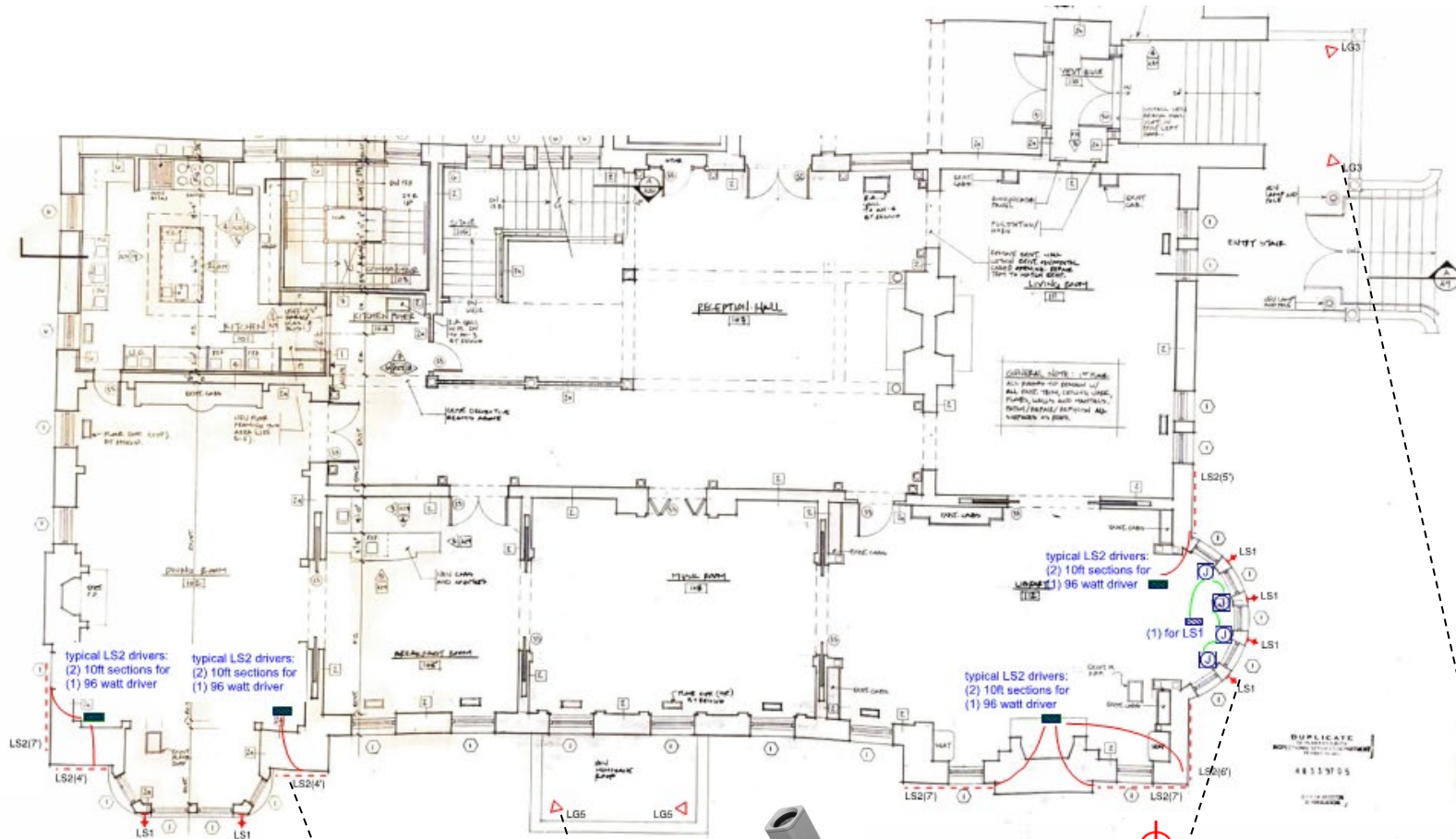

**Legend:**  **LS2**  
Grazing Architectural Protrusions

**LG5**   
Flooding Middle  
Façade for Soft Wash

**LS1**   
Grazing profiles  
At Bay Windows

**LG3**   
Flooding Volume  
at South Entry Stair



# Second Level

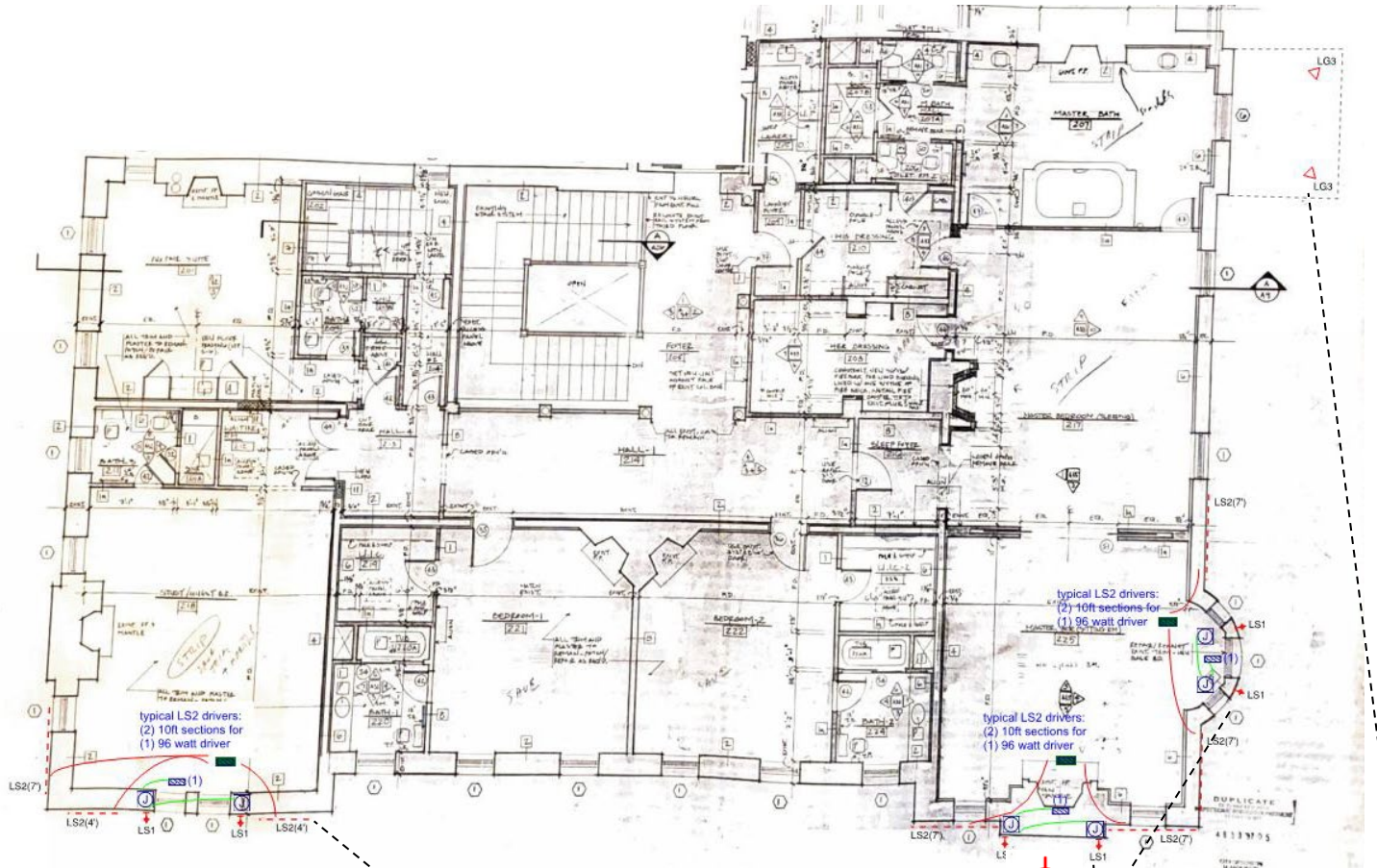

**Legend:**  **LS2**  
Grazing Architectural Protrusions

 **LS1**  
Grazing profiles  
At Bay Windows

 **LG3**  
Flooding Volume  
above South Entry Stair



# Third Level

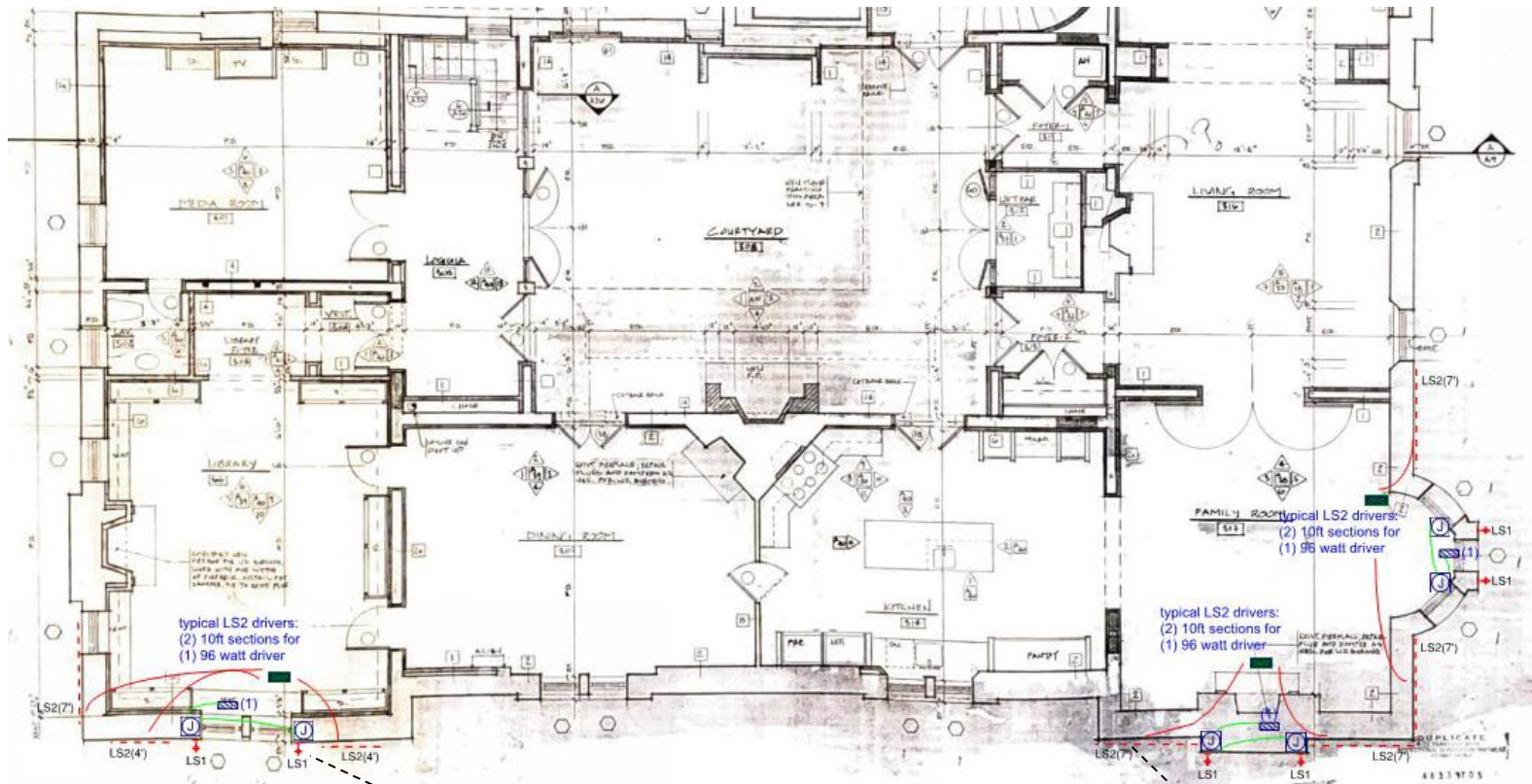

**Legend:**



**LS1**   
Grazing profiles  
At Bay Windows



**LS2**  
Grazing Architectural Protrusions



# Massachusetts Ave Elevation



Soft Up-light : Floods



Grazing : Pin-spots

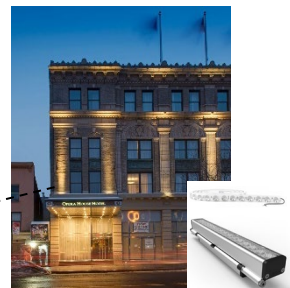

Grazing : Linears







# Mass Ave + Comm Ave Corner

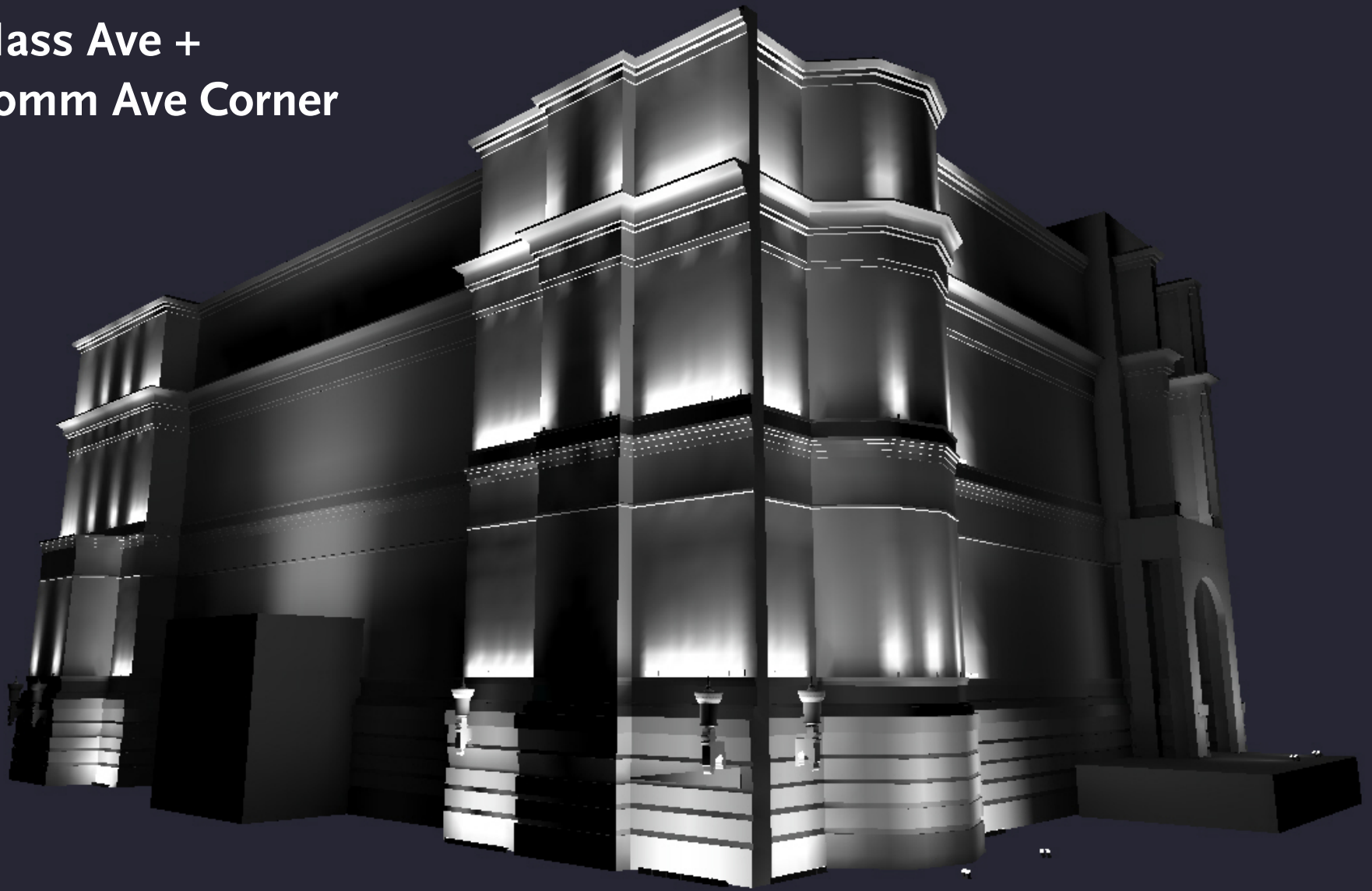

\* Lantern Street Level Lighting Not Illuminated



# Commonwealth Ave Elevation

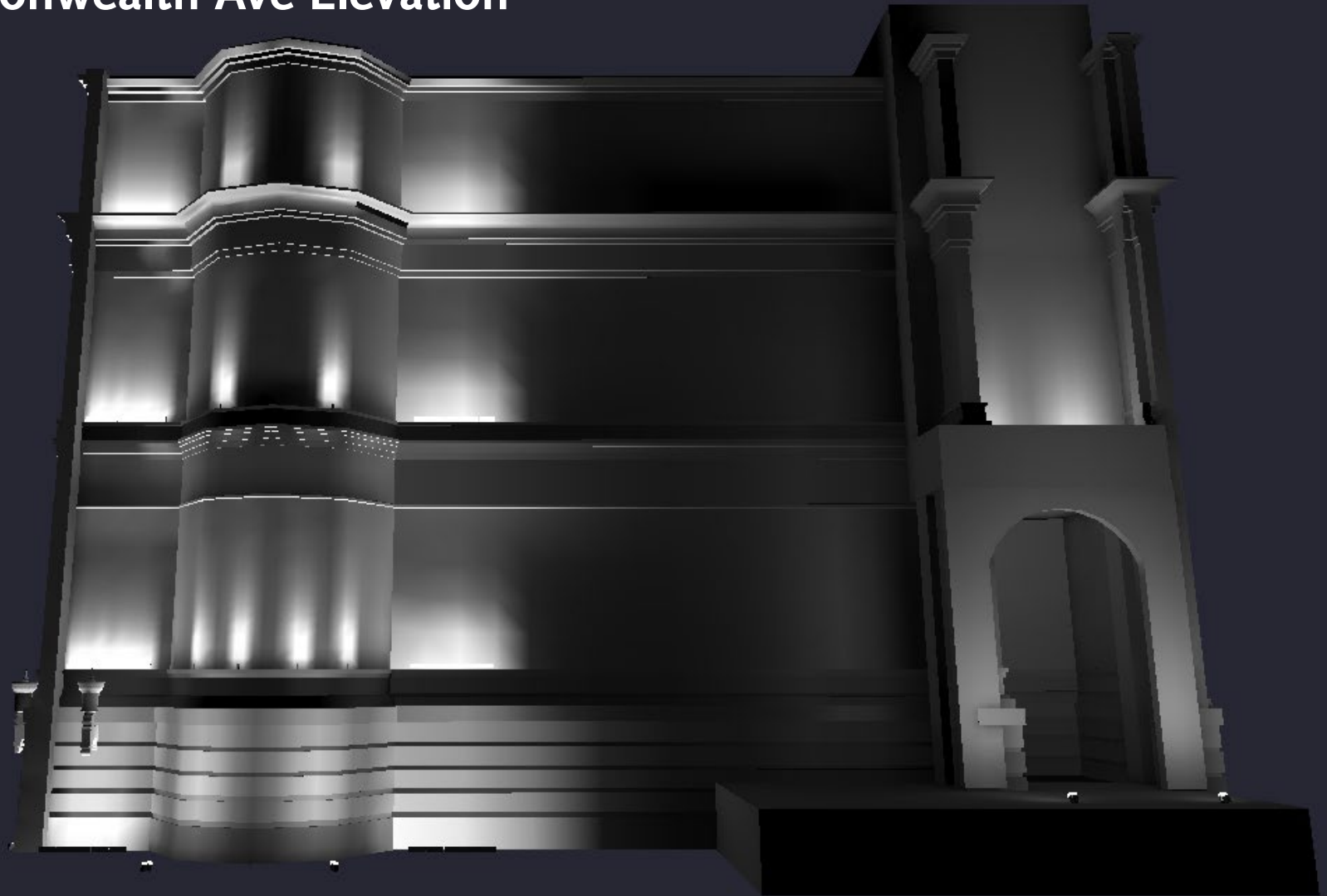

\* Lantern Street Level Lighting Not Illuminated





# Massachusetts Ave Elevation



\* Lantern Street Level Lighting Not Illuminated



# Public Alley 429 + Mass Ave Corner



\* Lantern Street Level Lighting Not Illuminated



THANK YOU

