

232 Clarendon St
Boston, MA 02116

Roof Deck Application



232 Clarendon St:
Mock Up of Roof Deck Location

232 Clarendon St
Boston, MA 02116

Roof Deck Application



232 Clarendon St:
Mock Up of Roof Deck Location

232 Clarendon St
Boston, MA 02116

Roof Deck Application



232 Clarendon St:
Mock Up of Roof Deck Location

232 Clarendon St
Boston, MA 02116

Roof Deck Application



232 Clarendon St:
Mock Up of Roof Deck Location

232 Clarendon St
Boston, MA 02116

Roof Deck Application



232 Clarendon St:
Mock Up of Roof Deck Location
Perspective from across the street at
Clarendon and Newbury

232 Clarendon St
Boston, MA 02116

Roof Deck Application



232 Clarendon St:
Mock Up of Roof Deck Location
Perspective from across the street at
Clarendon and Newbury - Close Up

232 Clarendon St
Boston, MA 02116

Roof Deck Application



232 Clarendon St:
Mock Up of Roof Deck Location
Perspective from across the street at
Clarendon and Newbury

232 Clarendon St
Boston, MA 02116

Roof Deck Application



232 Clarendon St:
Mock Up of Roof Deck Location
Perspective from across the street at
Clarendon St

232 Clarendon St
Boston, MA 02116

Roof Deck Application



232 Clarendon St:
Mock Up of Roof Deck Location
Perspective from across the street at
Clarendon St

232 Clarendon St
Boston, MA 02116

Roof Deck Application



232 Clarendon St:
Mock Up of Roof Deck Location
Perspective from across the street at
Newbury St

232 Clarendon St
Boston, MA 02116

Roof Deck Application



232 Clarendon St:
Mock Up of Roof Deck Location
Perspective from across the street at
Newbury St

232 Clarendon St
Boston, MA 02116

Roof Deck Application



232 Clarendon St:
Mock Up of Roof Deck Location
Perspective from across the street at
Newbury St - Close Up

232 Clarendon St
Boston, MA 02116

Roof Deck Application



232 Clarendon St:
Mock Up of Roof Deck Location
Perspective from across the street at
Newbury St - From rear looking back

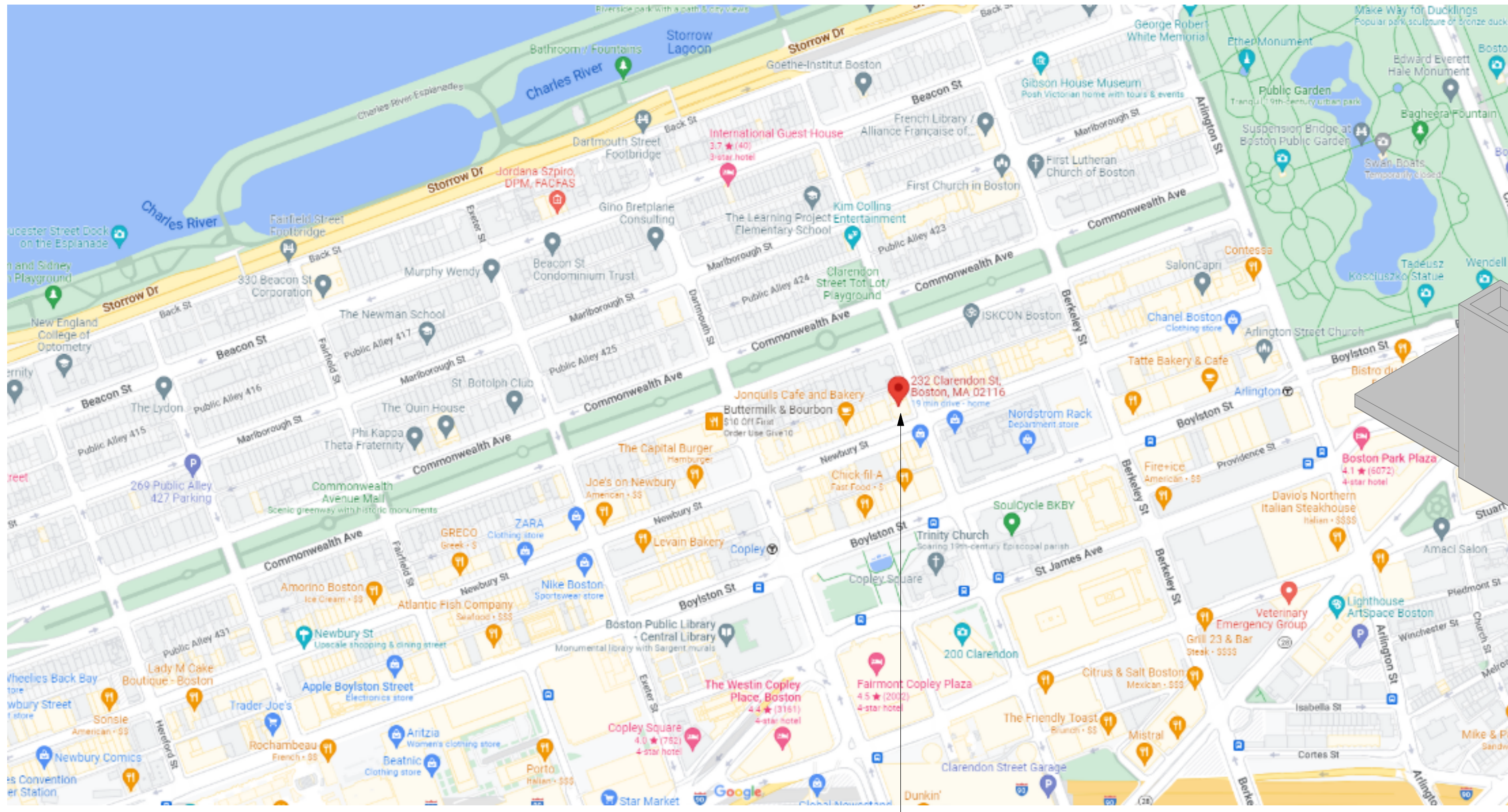

SITE

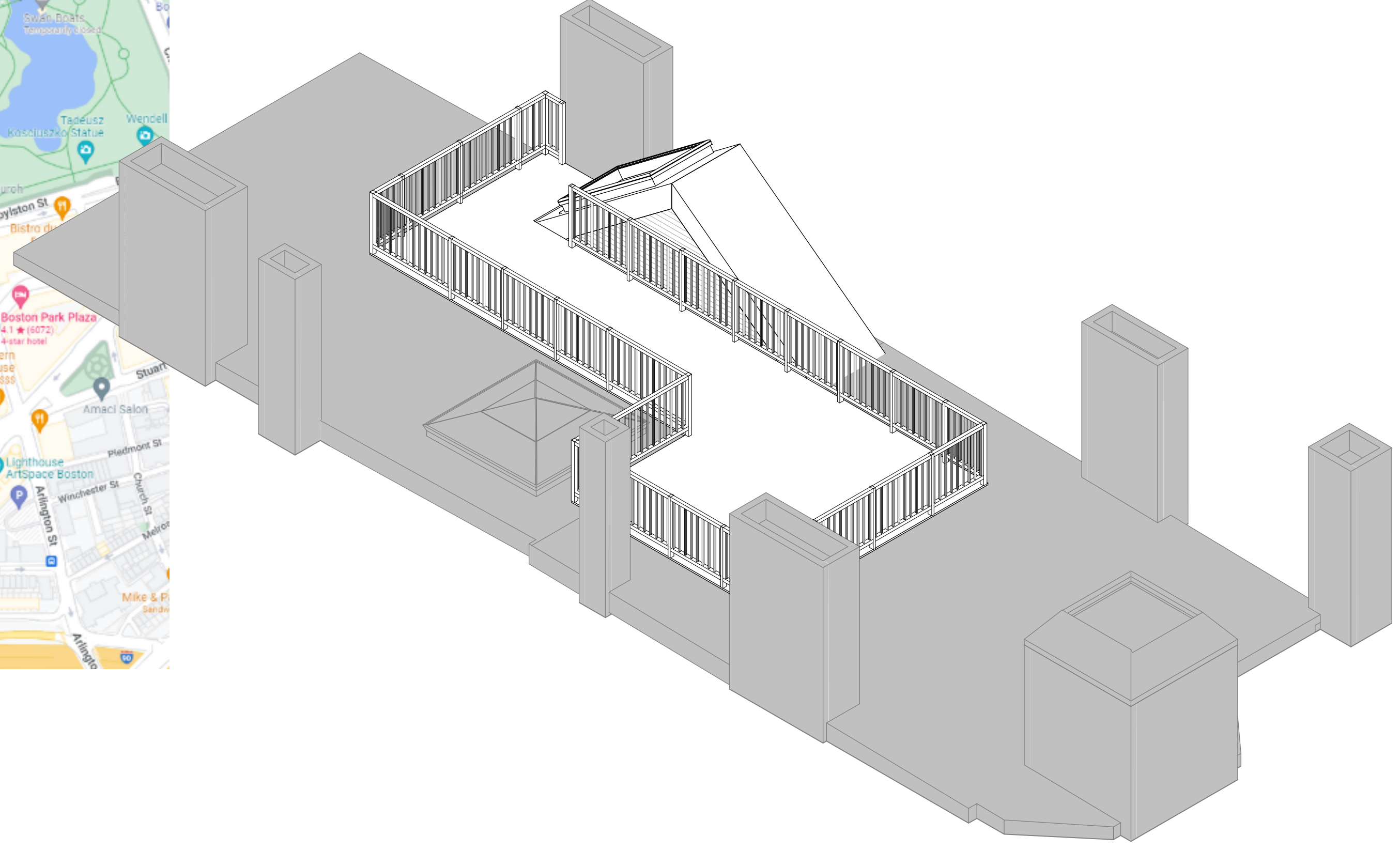

GENERAL NOTES:

1. THE WORK SHALL CONFORM TO THE APPLICABLE BUILDING CODE AND OTHER ORDINANCES, CODES AND REGULATIONS LISTED IN THE SPECIFICATIONS OR ON THE DRAWINGS, AND REQUIRED BY LOCAL BUILDING AUTHORITIES. THE GOVERNING CODES, RULES AND REGULATIONS ARE COLLECTIVELY REFERRED TO AS "THE CODE." THE CONTRACTOR SHALL REPORT ANY INCONSISTENCIES, CONFLICTS OR OMISSIONS DISCOVERED TO THE ARCHITECT FOR INTERPRETATION PRIOR TO PERFORMING THE WORK.
2. THE CONTRACTOR SHALL ASSUME SOLE AND COMPLETE RESPONSIBILITY FOR JOB SITE CONDITIONS DURING THE COURSE OF CONSTRUCTION OF THIS PROJECT INCLUDING SAFETY OF ALL PERSONS AND PROPERTY. THIS REQUIREMENT SHALL APPLY CONTINUOUSLY AND NOT BE LIMITED TO NORMAL WORKING HOURS. THE CONTRACTOR SHALL PROVIDE PUBLIC PROTECTION, AS NECESSARY AND REQUIRED BY GOVERNING AGENCIES HAVING JURISDICTION, UNTIL CLIENT ACCEPTANCE OF THE PREMISES.
3. THE GENERAL CONTRACTOR IS SOLELY RESPONSIBLE FOR THE PROVISION AND MAINTENANCE OF ALL BRACING, SHORING, ENCLOSURES, BARRIERS OR SCAFFOLDING REQUIRED TO PROVIDE A SAFE WORKING ENVIRONMENT AS DICTATED BY SITE CONDITIONS AND THE PROGRESS OF WORK.
4. DURING THE ENTIRE CONSTRUCTION PERIOD, ALL EXITS, EXIT LIGHTING, FIRE PROTECTION DEVICES AND ALARMS SHALL BE CONTINUOUSLY MAINTAINED IN CONFORMANCE WITH LOCAL BUILDING CODE AND OTHER GOVERNING ENTITY REQUIREMENTS. U.N.O., ALL EXISTING, SERVICES AND DEVICES SHALL REMAIN ACTIVE.
5. THE CONTRACTOR SHALL PROTECT THE PROPERTY FOR THE CLIENT AND THE BUILDING OWNER. INCLUDING, BUT IS NOT LIMITED TO, WINDOWS, FLOOR AND CEILING FINISHES, PUBLIC TOILETS, ELEVATORS, DOORS & BUICKS, ELECTRICAL AND AIR-CONDITIONING EQUIPMENT. THE CONTRACTOR SHALL PROTECT ADJOINING PROPERTY. DAMAGE CAUSED BY THE CONTRACTOR'S WORK OR WORKMEN MUST BE MADE GOOD, IN A TIMELY FASHION. PATCHING AND REPLACEMENT OF DAMAGED WORK SHALL BE PERFORMED AT THE COST OF THE CONTRACTOR SHALL BE FULLY RESPONSIBLE FOR ALL SUB-CONTRACTORS. IF THE CONTRACTOR FAILS TO COMPLETE THE REPAIRS IN A TIMELY FASHION, SAID REPAIRS WILL BE MADE BY A CONTRACTOR SELECTED BY THE OWNER'S REPRESENTATIVE AND BACK CHARGED ACCORDINGLY.
6. THE CONTRACTOR SHALL INDEMNIFY AND SAVE HARMLESS THE LANDLORD, THE TENANT, AND ARCHITECT AGAINST ANY AND ALL CLAIMS AND DEMANDS FOR THE DAMAGE TO THE PROPERTY OF ANY PERSON, FIRM OR INDIVIDUAL OR FOR PERSONAL INJURIES (INCLUDING DEATH) ARISING OUT OF, OR SUFFERED WHILE ENGAGED IN, OR CAUSED, IN WHOLE OR IN PART, BY THE EXECUTION OF THE WORK; THE CONTRACTOR SHALL WELL AND TRULY DEFEND THE LANDLORD, TENANT AND ARCHITECT AND SHALL PAY ALL MONIES AWARDED FOR SUCH DAMAGES OR INJURIES (INCLUDING DEATH). ALL COSTS INCLUDING ATTORNEY'S FEES SUSTAINED, AND SHALL OBTAIN A FULL ACQUITTANCE AND RELEASE IN FAVOR OF THE LANDLORD, TENANT AND ARCHITECT, UNLESS SUCH LIABILITY RESULTS SOLELY FROM THE NEGLIGENCE OF THE LANDLORD, TENANT, ARCHITECT, ITS AGENTS OR EMPLOYEES.
7. THE ARCHITECT SHALL NOT BE HELD RESPONSIBLE FOR THE PERFORMANCE OF ANY WORK, NOR FOR THE MEANS AND METHODS OF CONSTRUCTION CHOSEN BY THE CONTRACTOR OR ANY SUB-CONTRACTORS, NOR SHALL THE ARCHITECT GUARANTEE THE PERFORMANCE OF THEIR CONTRACTS.
8. THE CONTRACTOR SHALL PERFORM DAILY CLEANING OF THE JOB SITE DURING THE CONSTRUCTION PERIOD AND SHALL PROTECT FINISHED WORK FROM DAMAGE. IMMEDIATELY PRIOR TO TENANT OCCUPANCY, THE CONTRACTOR SHALL PERFORM FINAL CLEANING OF THE WORK AREA INCLUDING, BUT NOT LIMITED TO, WET WIPING OF FURNITURE, AND CASEWORK, WASHING AND WAXING OF VCT FLOORING AND THE VACUUMING OF CARPET. ALL CLEANING SHALL BE IN ACCORDANCE WITH MANUFACTURERS' RECOMMENDATIONS AND SMACNA IAQ GUIDELINES FOR OCCUPIED BUILDINGS.
9. THE CONTRACTOR IS RESPONSIBLE FOR COORDINATING THE WORK OF ALL SUB-CONTRACTORS AND SHALL PERFORM SUCH MISCELLANEOUS WORK AS MAY BE NECESSARY FOR THEM TO COMPLETE THEIR WORK. IT IS EXPECTED THAT THE CONTRACTOR SHALL ALSO CLOSELY COORDINATE THE WORK WITH THAT OF ALL OTHER VENDORS RETAINED BY THE CLIENT TO ASSURE THAT ALL SCHEDULES ARE MET AND THAT WORK PROCEEDS WITHOUT DELAY.
10. BIDDERS, BEFORE SUBMITTING PROPOSALS, SHALL VISIT AND CAREFULLY EXAMINE THE AREA AFFECTED BY THE WORK TO FAMILIARIZE THEMSELVES WITH THE EXISTING CONDITIONS AND THE DIFFICULTIES THAT WILL AFFECT THE EXECUTION OF THE WORK. SUBMISSION OF A PROPOSAL WILL BE CONSTRUED AS EVIDENCE THAT SUCH AN EXAMINATION HAS BEEN MADE, AND LATER CLAIMS WILL NOT BE RECOGNIZED FOR EXTRA LABOR, EQUIPMENT, OR MATERIALS, REQUIRED BECAUSE OF DIFFICULTIES ENCOUNTERED WHICH COULD HAVE BEEN REASONABLY FORESEEN HAD SUCH AN EXAMINATION BEEN MADE. THE GENERAL CONTRACTOR SHALL VERIFY ALL CONDITIONS AND DIMENSIONS ON THE JOB SITE AND REPORT ANY AND ALL DISCREPANCIES AND/OR UNUSUAL CONDITIONS TO THE ARCHITECT PRIOR TO FINALIZING BIDS OR COMMENCEMENT OF ANY CONSTRUCTION.
11. THE GENERAL CONTRACTOR SHALL MAKE KNOWN ANY AND ALL LIMITATIONS, EXCLUSIONS, OR MODIFICATIONS TO THE PROJECT DURING THE BID SELECTIONS PERIOD. ANY AND ALL LIMITATIONS, EXCLUSIONS, OR MODIFICATIONS NOT ITEMIZED IN THE BID PROPOSAL DOCUMENTS ARE PRESUMED "INCLUDED", IN WHICH CASE NO ADDITIONAL MONIES WILL BE ALLOCATED FOR THIS WORK.
12. EXISTING CONSTRUCTION AND DIMENSIONS SHOWN ARE PER EXISTING DRAWINGS. ALL EXISTING INFORMATION MUST BE VERIFIED IN THE FIELD. NEITHER THE OWNER NOR THE ARCHITECTS ARE RESPONSIBLE FOR ACCURACY OF EXISTING INFORMATION. EXISTING CONSTRUCTION CONDITIONS IN AREAS WHERE NEW WORK IS NOT PLANNED MAY BE NOT COMPLETELY SHOWN.
13. WITHIN ONE (1) WEEK (5 BUSINESS DAYS), OF THE AWARD OF THIS CONTRACT, PRIOR TO MOBILIZATION FOR ANY WORK, THE CONTRACTOR SHALL FURNISH A CONSTRUCTION SCHEDULE SHOWING CHRONOLOGICALLY THE PHASES OF THE WORK, AND ALL RELATED WORK FOR THE COMPLETION OF THE PROJECT. THIS SCHEDULE SHALL INDICATE ALL ORDERING LEAD TIMES, LENGTH OF TIME FOR EACH PHASE, ITS START AND COMPLETION, WITH A PROJECTED COMPLETION DATE.
14. CONTRACTOR AND SUBCONTRACTORS SHALL ATTEND JOB MEETINGS REQUIRED BY THIS CONTRACT.
15. ALL REQUIRED PERMITS MUST BE OBTAINED FROM THE FIRE DEPARTMENT PRIOR TO START OF CONSTRUCTION.
16. ALL COSTS FOR INSPECTIONS AND/OR TESTS SHALL BE THE RESPONSIBILITY OF THE CONTRACTOR, U.N.O.
17. DO NOT SCALE THESE DRAWINGS; WRITTEN DIMENSIONS SHALL GOVERN. SHOULD ANY DIMENSIONAL DISCREPANCIES BE ENCOUNTERED, CLARIFICATIONS SHALL BE OBTAINED FROM THE OFFICE OF THE ARCHITECT.
18. LARGE SCALE DETAILS SHALL GOVERN OVER SMALLER SCALE PLANS AND ELEVATIONS.
19. THE CONTRACTOR AND EACH SUBCONTRACTOR SHALL WARRANTEE ALL WORK PERFORMED BY HIM DIRECTLY FOR A MINIMUM PERIOD OF ONE (1) YEAR AS SPECIFIED IN THE CONSTRUCTION CONTRACT. ALL DEFECTS OCCURRING IN THE GUARANTEED PERIOD SHALL BE CORRECTED AT NO ADDITIONAL COST.
20. THE CLIENT, ARCHITECT, CONSULTANTS AND ALL INSPECTORS FROM PERTINENT AGENCIES SHALL BE PERMITTED ACCESS TO THE JOB SITE AT ALL TIMES DURING NORMAL WORKING HOURS.
21. THE CONTRACTOR SHALL PROVIDE ALL LABOR, MATERIALS, AND EQUIPMENT TO EXECUTE ALL WORK, EXCEPT WHERE NOTED AS NOT IN CONTRACT (N.I.C.).
22. MINOR DETAILS NOT SHOWN OR SPECIFIED, BUT NECESSARY FOR PROPER CONSTRUCTION OF ANY PART OF THE WORK, SHALL BE INCLUDED AS IF THEY WERE INDICATED IN THE DRAWINGS, UNLESS OTHERWISE AGREED UPON. WHERE THE CONTRACT, CONSTRUCTION NOTES OR DRAWINGS CALL FOR ANY WORK OF A MORE STRINGENT NATURE THAN THAT REQUIRED BY THE BUILDING CODE, OR ANY OTHER ENTITY HAVING JURISDICTION OVER THE WORK, THE WORK OF THE MORE STRINGENT NATURE CALLED SHALL BE FURNISHED IN ALL CASES.

APPLICABLE CODES:
NINTH EDITION OF THE MASSACHUSETTS STATE BUILDING CODE 780

Drawing List		
Sheet Number	Sheet Name	Sheet Issue Date
A-000	Cover Sheet	01/24/2023
A-100	Floor and Roof Plans	01/24/2023

PROJECT: Roof Deck Addition

Back Back Review Submission 01.24.2023

CLIENT:
Hemenway Construction

ARCHITECT
Sol and Associates Inc

ADDRESS:
523 Medford St,
Charlestown, MA 02129

T: 617-869-6806

PROJECT NAME

Roof Deck

PROJECT ADDRESS

232 Clarendon St
Boston, MA

CLIENT

Hemenway Construction

ARCHITECT

SOL AND ASSOCIATES INC
523 MEDFORD ST
CHARLESTOWN, MA 02129
TELEPHONE: 617-869-6806

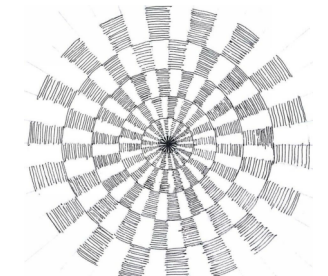

CONSULTANTS:

COPYRIGHT SOL AND ASSOCIATES INC © 2023
THESE DRAWINGS ARE NOW AND DO REMAIN THE SOLE PROPERTY OF SOL AND ASSOCIATES INC. USE OF THESE PLANS OR ANY FORM OF REPRODUCTION OF THIS DESIGN IN WHOLE OR IN PART WITHOUT EXPRESS WRITTEN CONSENT IS PROHIBITED AND SHALL RESULT IN THE FULLEST EXTENT OF PROSECUTION UNDER LAW

REGISTRATION



Project number HC22-001
Date 01/24/2023
Drawn by ars
Checked by sa
Scale 1/2" = 1'-0"

REVISIONS

No.	Description	Date

Cover Sheet

A-000

Roof Deck

PROJECT NAME

Roof Deck

PROJECT ADDRESS

322 Clarendon St
Boston, MA

CLIENT

**Hemenway
Construction**

ARCHITECT

SOL AND ASSOCIATES INC
523 MEDFORD ST
CHARLESTOWN, MA 02129
TELEPHONE: 617-869-6806

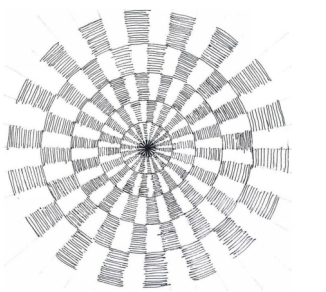

CONSULTANTS:

COPYRIGHT SOL AND ASSOCIATES INC ©
2023
THESE DRAWINGS ARE NOW AND DO
REMAIN THE SOLE PROPERTY OF SOL AND
ASSOCIATES INC. USE OF THESE PLANS
OR ANY FORM OF REPRODUCTION OF THIS
DESIGN IN WHOLE OR IN PART WITHOUT
EXPRESS WRITTEN CONSENT IS
PROHIBITED AND SHALL RESULT IN THE
FULLEST EXTENT OF PROSECUTION
UNDER LAW

REGISTRATION



Project number HC22-001
Date 01/24/2023
Drawn by ars
Checked by sa
Scale As indicated

REVISIONS

No.	Description	Date

Floor and Roof Plans

A-100

Roof Deck

LEGEND

- NEW WALL
- EXISTING WALL TO REMAIN
- EXISTING WALL TO BE DEMOLISHED
- EXISTING AREA TO REMAIN

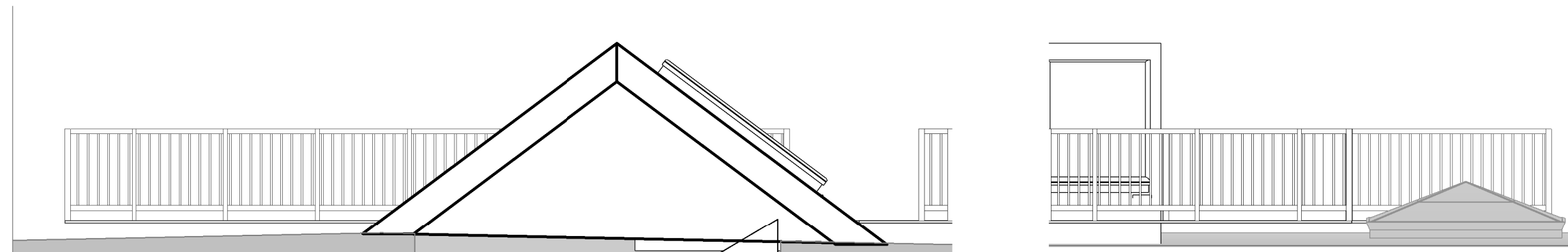

6 North Elevation @ Roof
1/4" = 1'-0"

7 West Elevation @ Roof
1/4" = 1'-0"

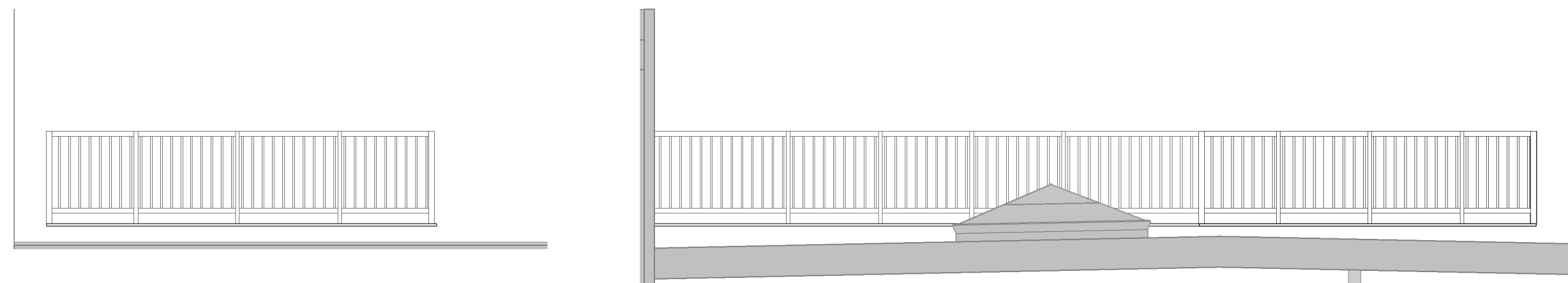

4 East Elevation @ Roof
1/4" = 1'-0"

5 South Elevation @ Roof
1/4" = 1'-0"

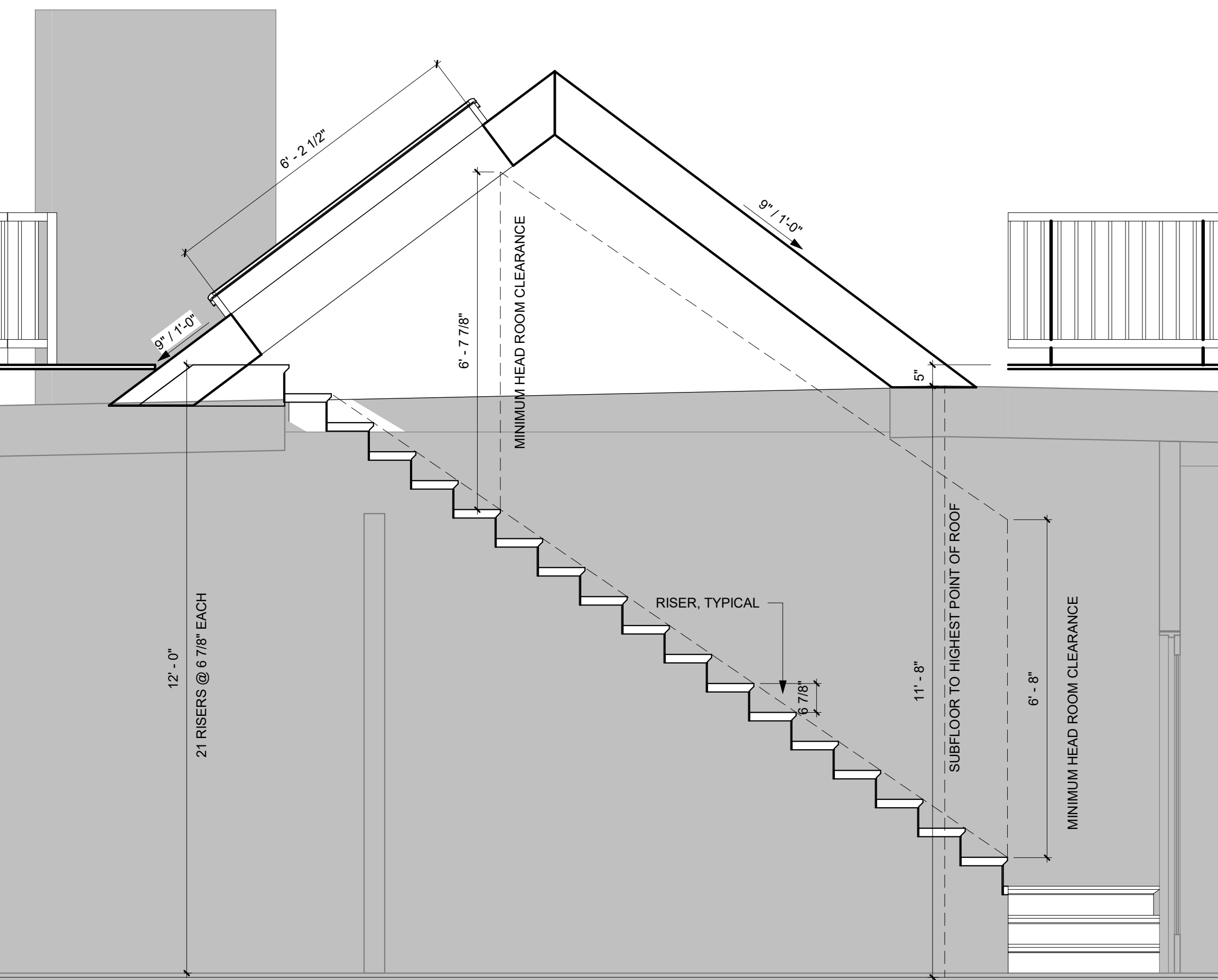

3 Section @ Roof Access Stair
1/2" = 1'-0"

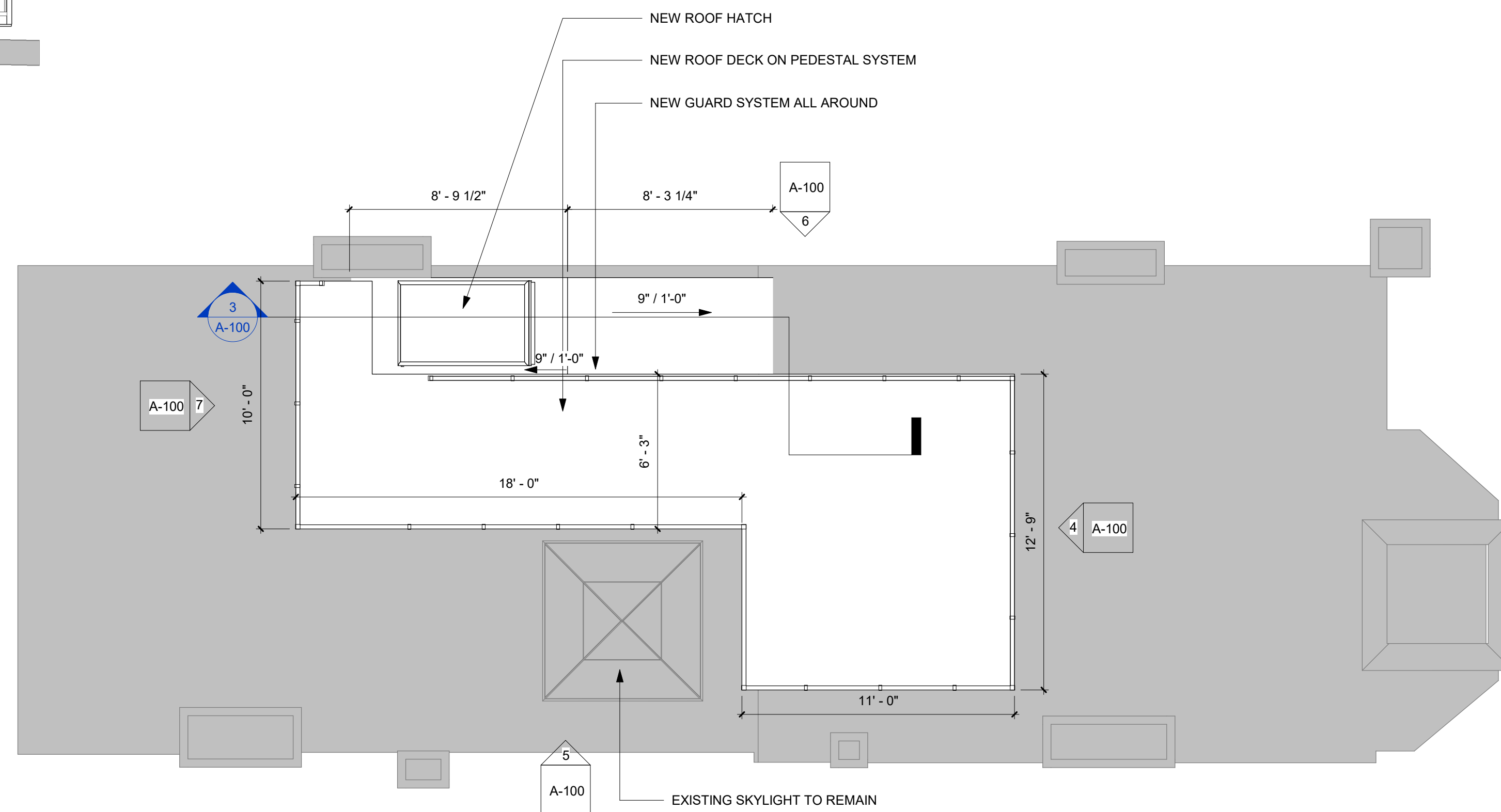

2 Roof Plan
1/4" = 1'-0"

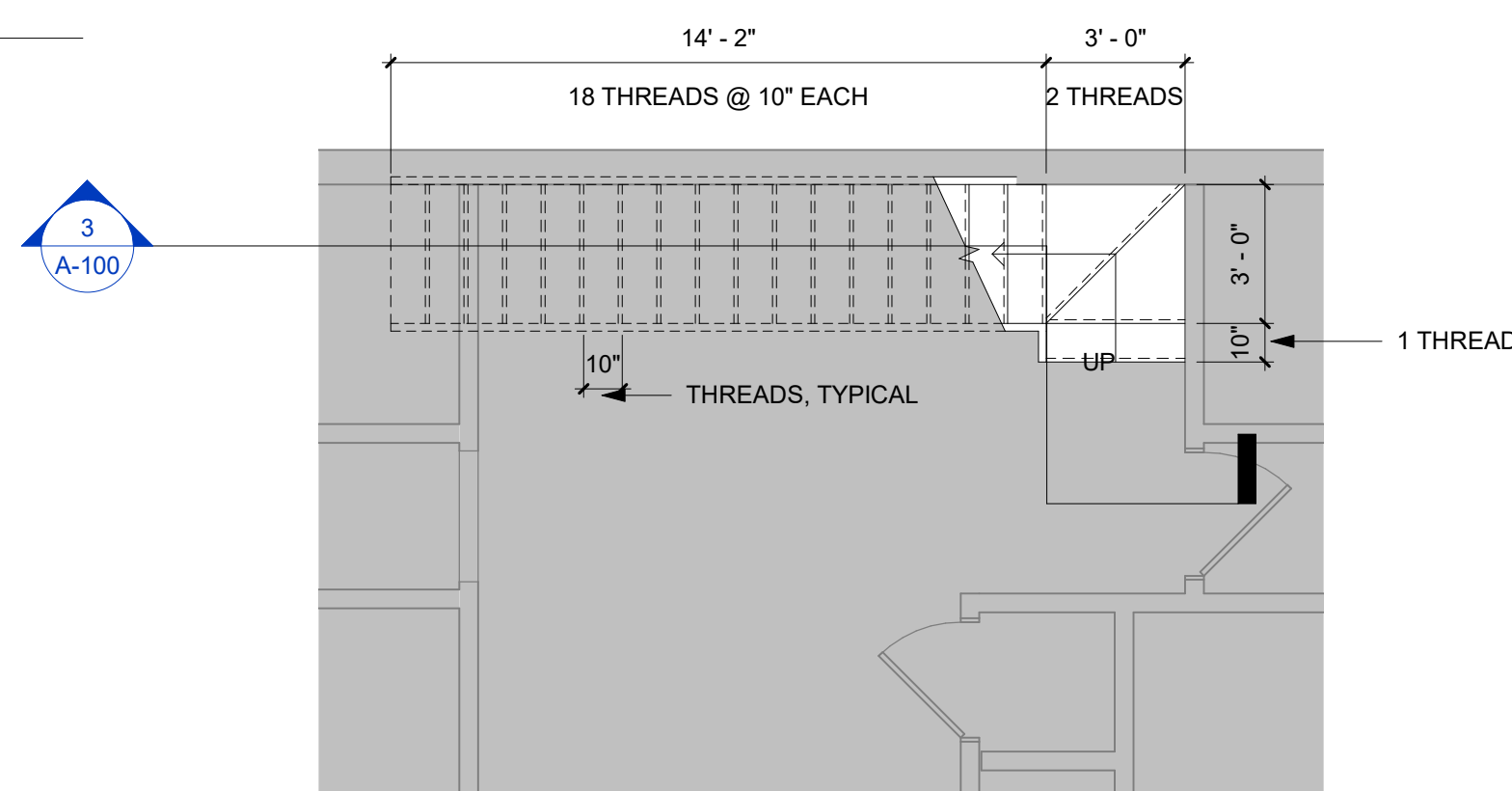

1 Partial 5th Floor Plan
1/4" = 1'-0"

Hemenway Construction
781-588-6632
Info@HemenwayCM.com



35 Batchelder St #D
Boston, MA 02119
HemenwayCM.com

Bid Proposal

Wednesday, August 30, 2023

Attn: DCB & Associates
575 Boylston St
Boston, MA 02116

Subject: Bray RE HQ
232 Clarendon St
Boston, MA 02116

Clarification:

- Access Hatch:
 - o Daylighter Roof Access Door, 36" x 74"
 - o See attached cut sheet
- Railings:
 - o Fortress Fe26 Aluminum Railing System
 - o All Black aluminum railing system set at 42" height above roof deck
 - o See attached cut sheet



Project Name:	232 Clarendon Street	Dayliter Skylights 5492 - 275th Street Langley, BC, V4W 3X7 Toll Free: 1-800-268-4068
Site Super:	Chris Hemenway	

GLASS ROOF ACCESS HATCH DIMENSION SHEET

Please provide the following information so that we can manufacture your roof access hatch to your specific application. Please fax back the information to 604-856-4560 (toll free fax# 1-877-268-8019) or forward it attached to an email to info@dayliter.com

Name:	Hemenway Construction	Phone#:	781	588	6632
Company:	Hemenway Construction	Cell#:	781	588	6632
Address:	232 Clarendon Street	Tax ID:			
City:	Boston, MA	Email:	info@hemenwaycm.com		
Postal / Zip Code:	02116	Shipping Address:	232 Clarendon Street Boston, MA 02116		

Figure: (Door Jamb Dimensions - plus - Diagram A+B)		Dimensions here please:	
Please refer to the required details on "Page 2 of 2"			
①	Inside Curb / Inside Door Jamb Rough Opening of Width? (ICRO) (See <u>"Roof Door Curb & Jamb Preparation Requirements"</u> from Dayliter)	=	36.75 inches
②	Inside Curb / Inside Door Jamb Rough Opening of Length? (ICRO) (See <u>"Roof Door Curb & Jamb Preparation Requirements"</u> from Dayliter)	=	74.5 inches
A)	Distance between finished deck & top of finished door jamb? (min 6"; Sill Detail to match Diagram)	=	6.5 inches
B)	Exterior face requires a minimum clearance of 4" (no obstructions)	=	4" min.inches
C)	Distance between top landing & top of door jamb? (Check local building code for trip hazard height)	=	8.25 inches
D)	Run of landing? (Min 9" to Max 14-9/16")	=	10" inches
E)	Run of step? (Min/Max per local building code)	=	10" inches
F)	Rise of step? (Min/Max per local building code)	=	7.25 inches
G)	Pitch of door jamb – 5/12 (22.5*) OR 7/12 (30.5*) OR 9/12 (37*) <u>VARIATIONS NEED TO BE APPROVED BY DAYLITER</u>	=	7/12 degrees
H)	Min. distance - finished door jamb to a finished Barrier? (Wall, railing, etc. = min 3.5")	=	6 inches
I)	Maximum width of finished door jamb? (max 1 and 7/8" after all "Build-up")	=	1 3/4" inches
J)	Color of aluminum exterior cap?	<input type="checkbox"/> Custom	<input type="checkbox"/> Brown <input checked="" type="checkbox"/> Black
K)	Color of steel counter flashing?	<input type="checkbox"/> Custom	<input type="checkbox"/> Brown <input checked="" type="checkbox"/> Black
L)	Crating or Palletizing required?	<input type="checkbox"/> Palletizing	<input checked="" type="checkbox"/> Crating
M)	Roof Access Hatch Quantity?	=	1 Roof Access Hatch(es)
N)	Optional Handle?	<input type="checkbox"/> Yes <input type="checkbox"/> No	<input type="checkbox"/> Custom <input type="checkbox"/> Brown <input checked="" type="checkbox"/> Black
O)	*Note: Sealed units specifications: 4mm 366 Temp – 1/2 SuperSpacer – Argon – 6mm Clear Temp Lami		

Date and Signature by Owner / Site Super	Date: <u>6</u> / <u>8</u> / <u>2023</u>	Signature: _____
--	---	------------------

GH

Dayliter

SKYLIGHTS

THE BRIGHTER IDEA

Diagram A:

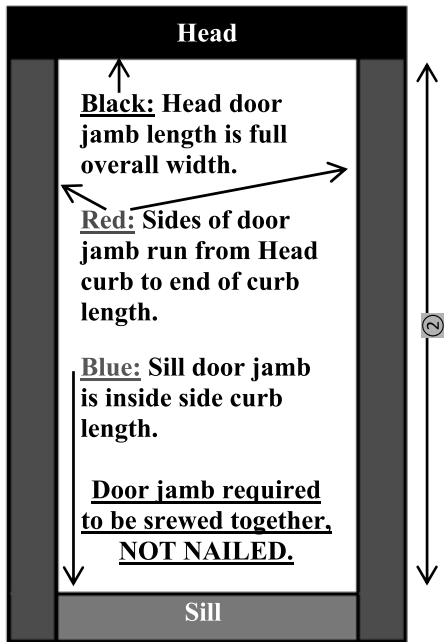
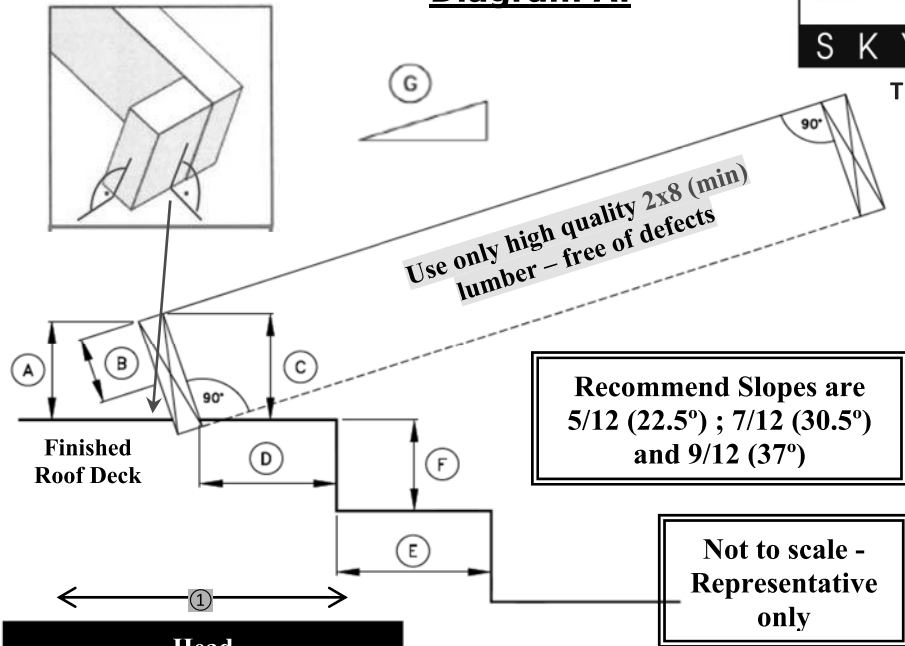

Inside Curb Rough Opening (ICRO) – Wood to Wood - Top & Base of Door Jamb Height. It is critical that the door jamb is 100% square.

Standard Models		
Model	Width ①	Length ②
3676	30.75"	70.5"
4280	36.75"	74.5"
36100	30.75"	84.5"

Vancouver, B.C. Models		
Model	Width ①	Length ②
VCR 3676	32.5"	70.5"
VCR 4280	36.75"	74.5"
VCR 36100	32.5"	84.5"

For roof access hatch installs in the City of Vancouver, B.C., the Vancouver minimum width is **32.5 inches.**

Diagram B:

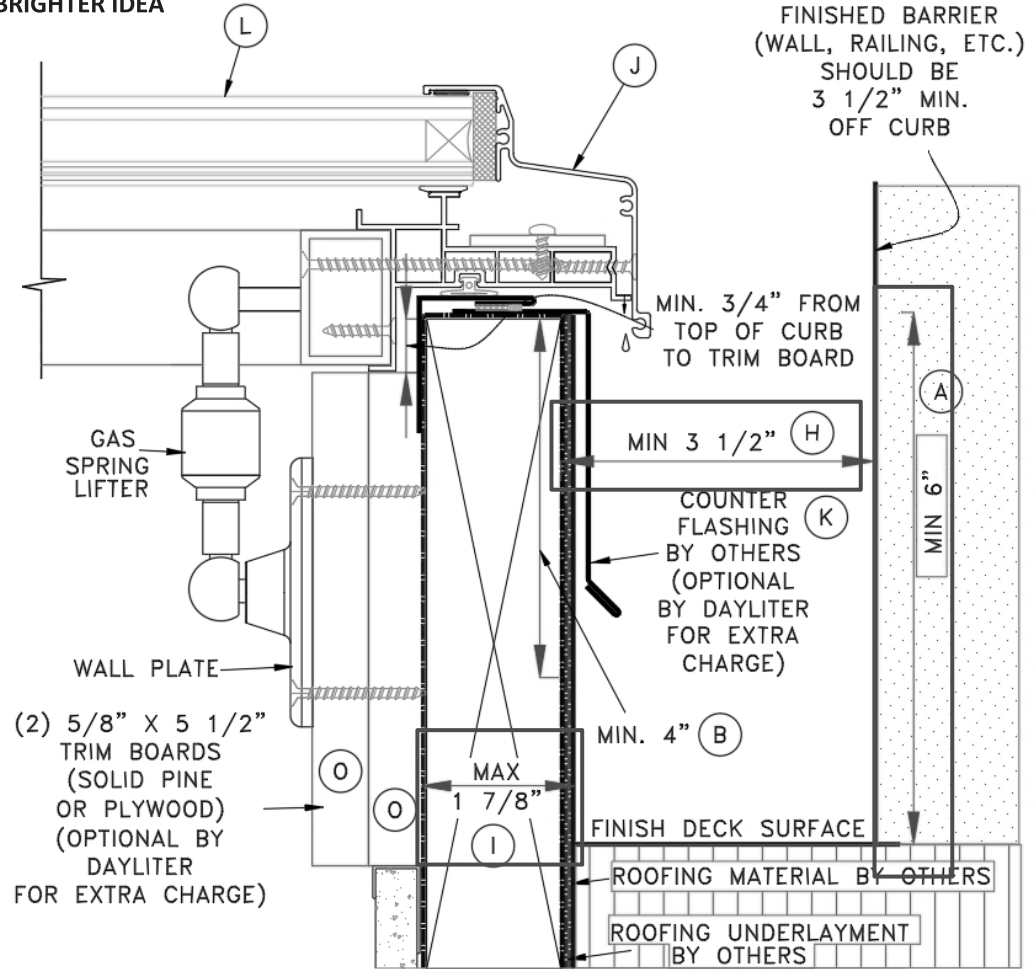

- WOOD BLOCKING BY OTHERS; MIN SIZE = 2x8 (1 1/2" x 7 1/2")
- INSIDE DOOR JAMB DIM = WOOD TO WOOD DIM

by *[Signature]* principal

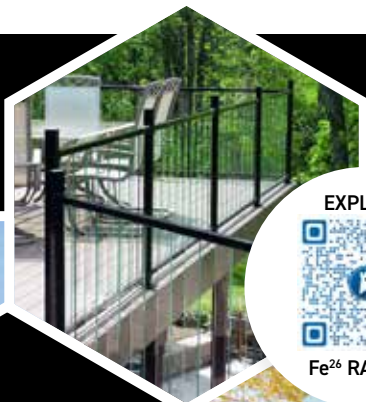

Fe²⁶ STEEL RAILING



THE STRENGTH OF STEEL. THE POWER OF FORTRESS.

Fe²⁶ steel railing stands strong and stands out. You'll rest easy knowing your railing brings unparalleled durability and elegance to any patio, deck or balcony. And achieving your outdoor vision has never been easier thanks to the countless ways to customize. Sustainably built, this railing system will provide safety and style for years to come.

**EASY TO
INSTALL &
MAINTAIN**

**RESISTS
RUST &
CORROSION**

**CUSTOM
DESIGN
OPTIONS**

MORE WAYS TO CUSTOMIZE

Completely customizable and affordable with an array of infill panel options to add personality to any outdoor living space.

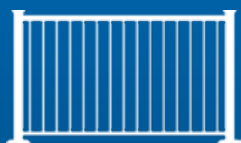

Fe²⁶
Traditional Infill



Fe²⁶ Axis
Horizontal Infill

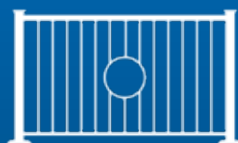

Fe²⁶
Ornamental Infill

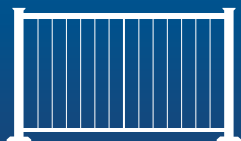

Fe²⁶ V-Series*
Cable Infill



Fe²⁶ H-Series*
Cable Infill



Fe²⁶ Pure View®
Glass Baluster Infill

*Approved for residential and commercial applications

EASY AS



FORTRESS



FortressAccents™
LIGHTING

KEY FEATURES & BENEFITS

LOW MAINTENANCE | FortressShield technology with an added layer of anti-corrosion protection and finished with a premium powder coat for superior corrosion resistance. You can rest assured that your investment remains looking great for years to come.

EASY INSTALLATION | Save time and money with options for panelized infills and pre-attached brackets on posts.

SAFE & CODE COMPLIANT | Durable steel is tested to ensure peace of mind for your family and friends. Backed by a 15-year limited warranty.

WEATHER RESISTANT | UV fade and moisture resistance locks in the beauty the first day and every day.

DESIGN CUSTOMIZATION | Find your perfect look with three top rail options, including a drink rail and 6 infill options. Add FortressAccents™ LED Lighting and safely enjoy your outdoor space anytime, day or night.

FortressShield TECHNOLOGY

We stand by your side and behind our Fe²⁶ steel railing with a 15-year warranty and a hassle-free claims process. Visit FortressBP.com for complete warranty details and exclusions.



- Premium Powder Coat
- Anti-Corrosion
- Quality Pre-Treatment
- Zinc Galvanized Coat



PREMIUM FINISHES

Cable & Axis infill panels in black sand only.



RESOURCES

Looking for more information?
View Fe²⁶ steel railing product guide.

EXPLORE



PRODUCT GUIDE



FORTIFY THE FUTURE™

Our Commitment To You

Together we build a stronger tomorrow with smart, sustainable and socially responsible solutions.



FortressBP.com | 866.323.4766