

# *Sally's* PIZZA

EXTERIOR MODIFICATIONS SUBMISSION  
30 THOMSON PLACE ALLEY



# DESIGN REVIEW TOPICS

LOCATION OF BUILDING WITHIN DISTRICT

EXISTING PHOTOS

PROPOSED ELEMENTS

- 30 THOMSON PLACE - EXISTING CONDITIONS
- 30 THOMSON PLACE - ARCHITECTURAL MODIFICATIONS
- 30 THOMSON PLACE – MECHANICAL DETAILS
- 30 THOMSON PLACE – ROOFTOP EQUIPMENT SIGHTLINES AND LAYOUT

NEIGHBORHOOD PHOTOS

HISTORIC PHOTOS

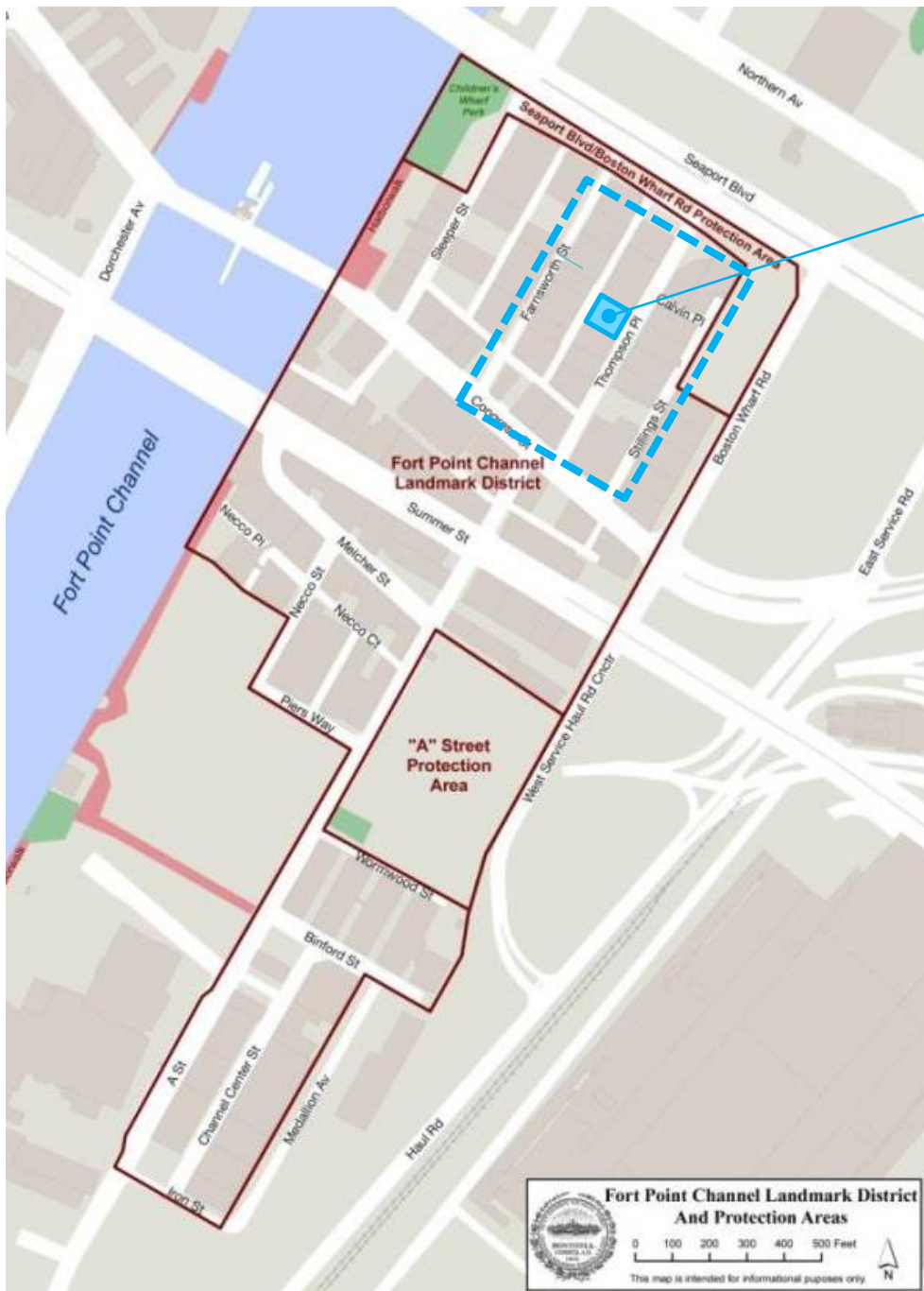

30 THOMSON PLACE

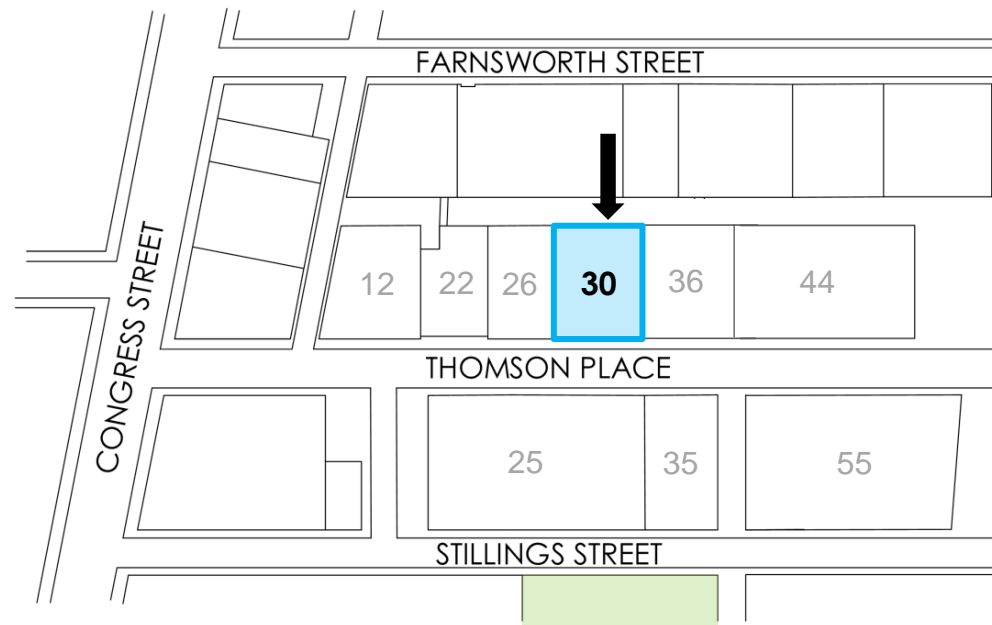

PROJECT LOCATION MAP

# FORT POINT CHANNEL LANDMARK DISTRICT

02.08.2024



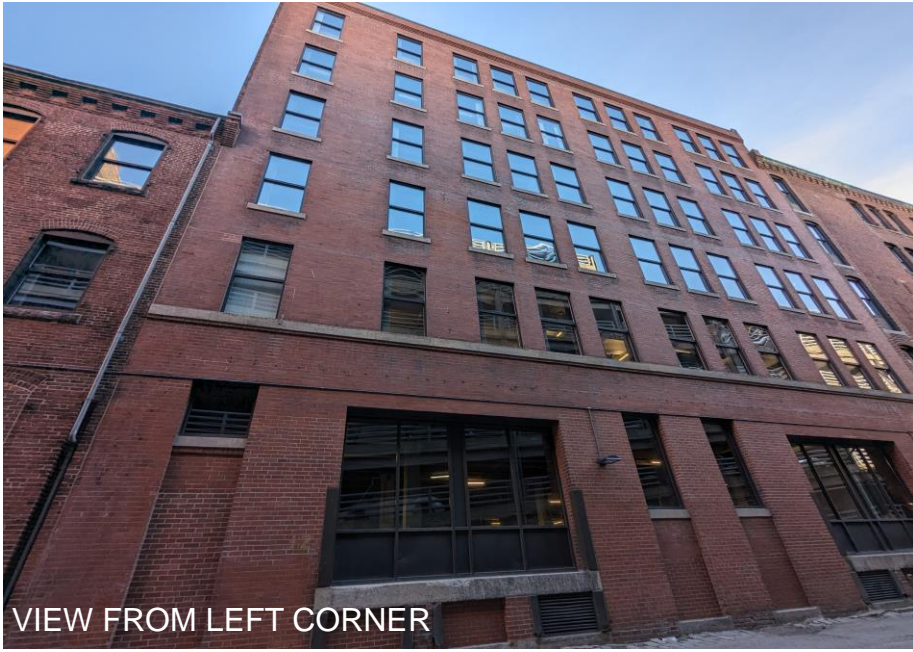

VIEW FROM LEFT CORNER



VIEW FROM RIGHT CORNER



PHOTO COMPILATION OF ELEVATION

EXISTING CONDITION PHOTOS

02.08.2024

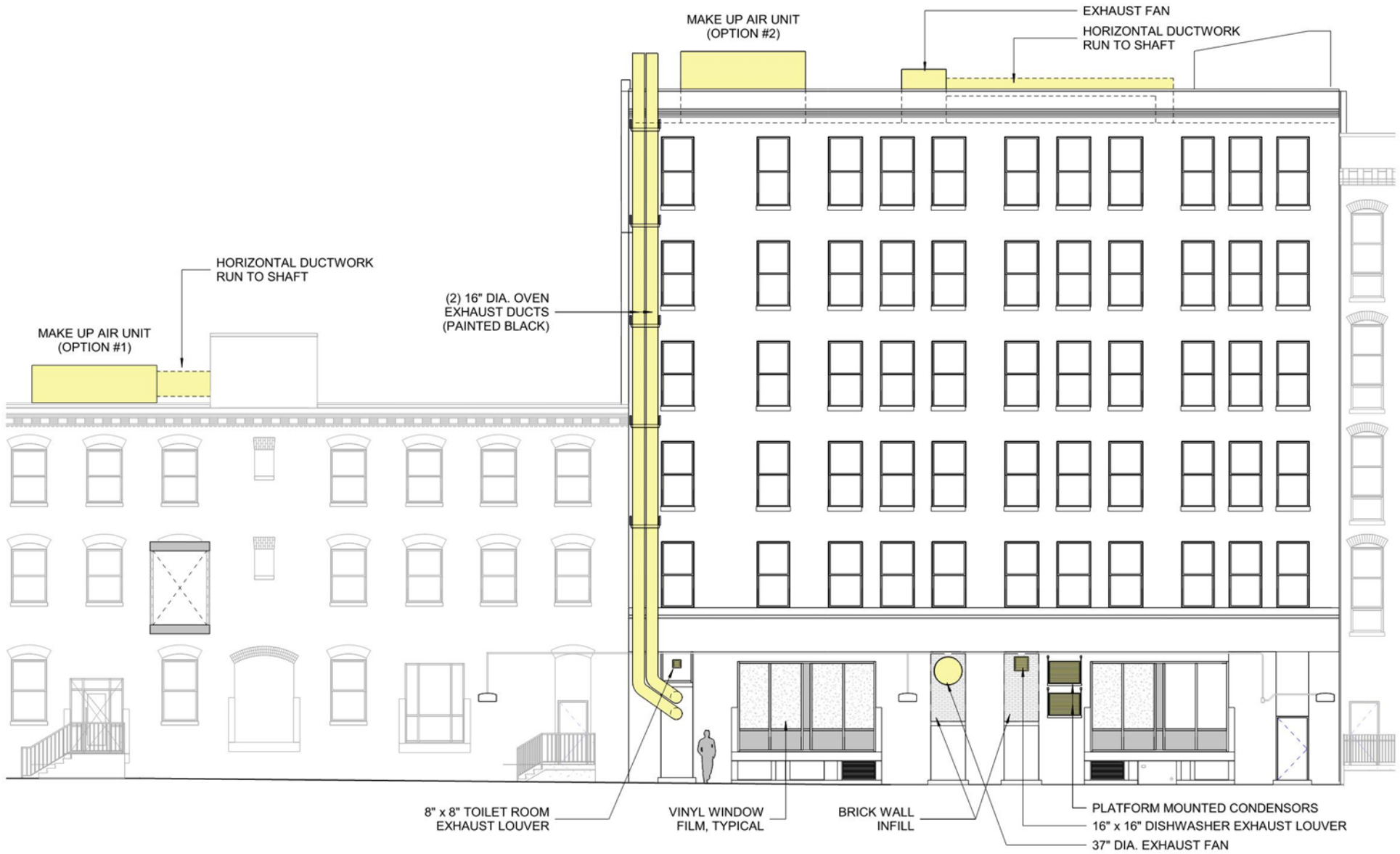

RENDERED ELEVATION OF PROPOSED CHANGES

02.08.2024

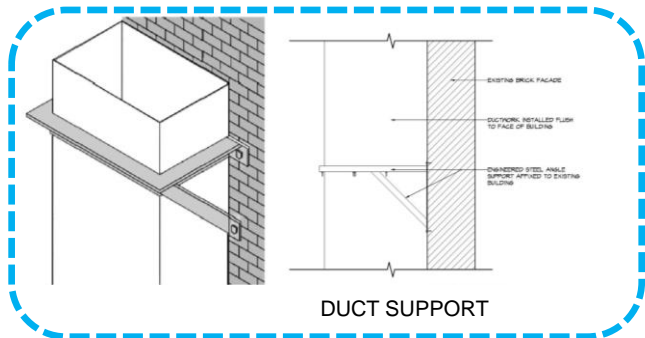

DUCT SUPPORT



PIZZA OVEN EXHAUST

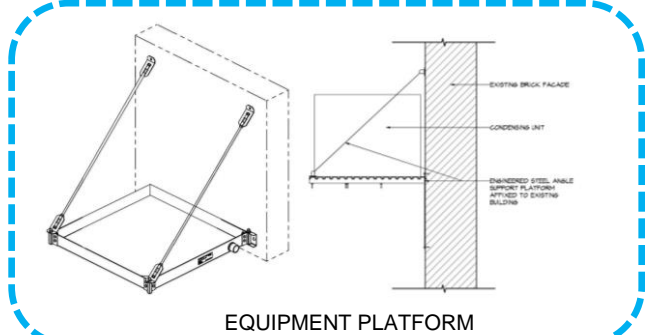

EQUIPMENT PLATFORM

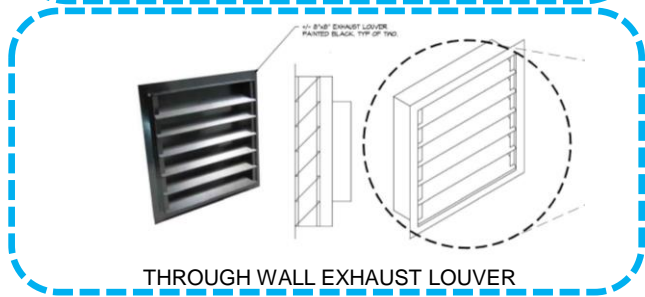

THROUGH WALL EXHAUST LOUVER

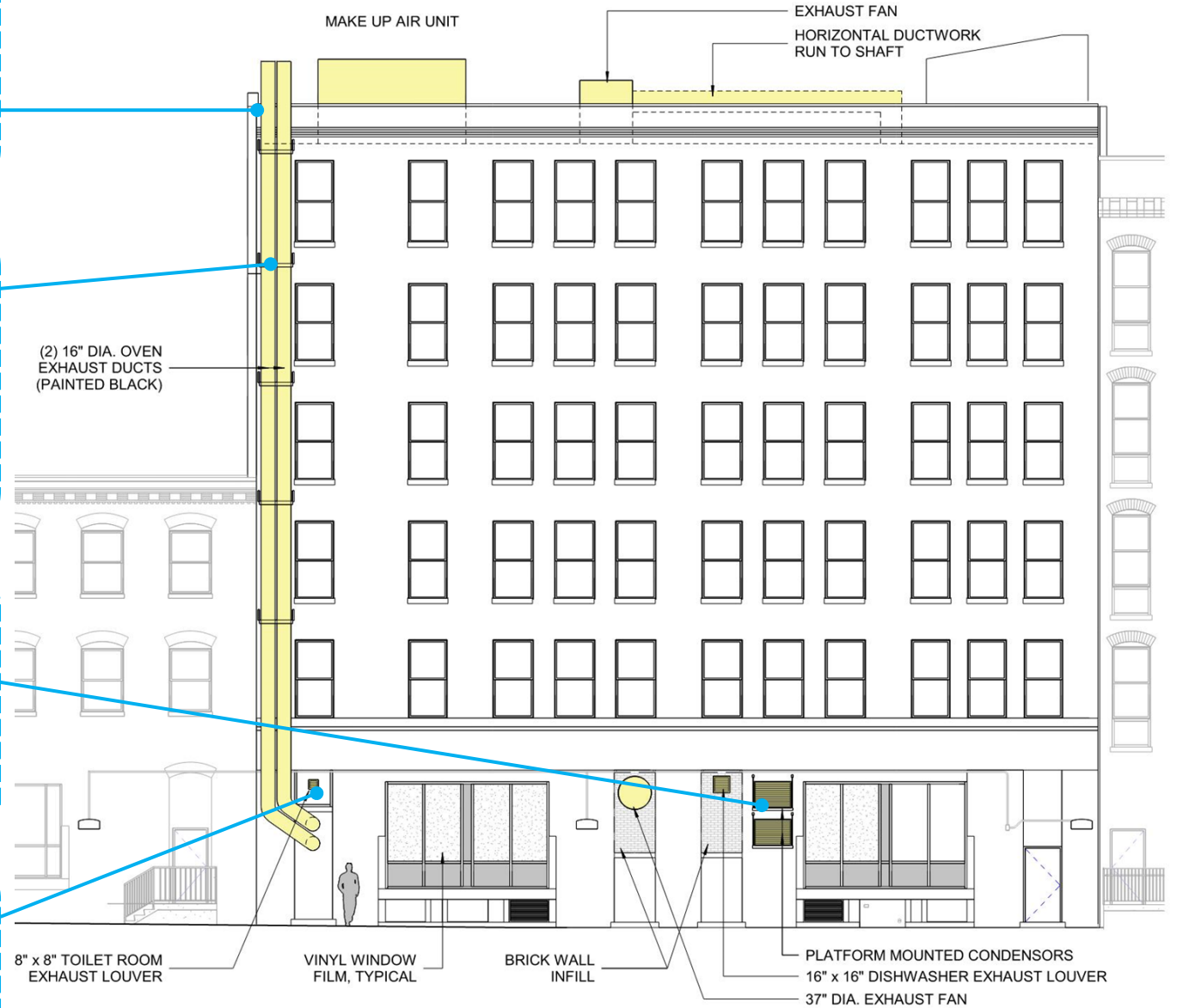

MECHANICAL DETAILS

02.08.2024



# RENDERED ELEVATION OF MODIFICATIONS

02.08.2024

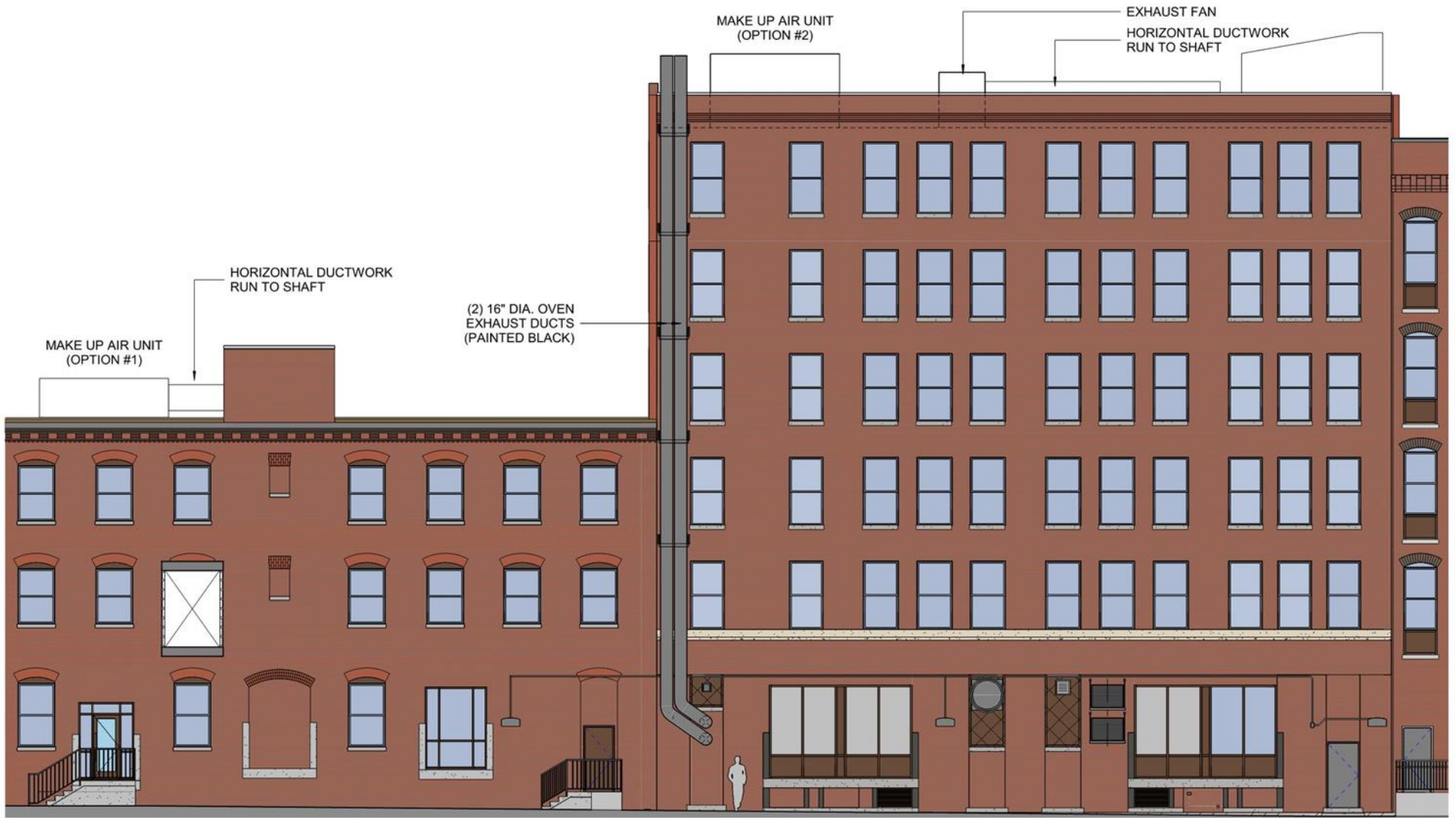

RENDERED ELEVATION OF PROPOSED CHANGES

02.08.2024



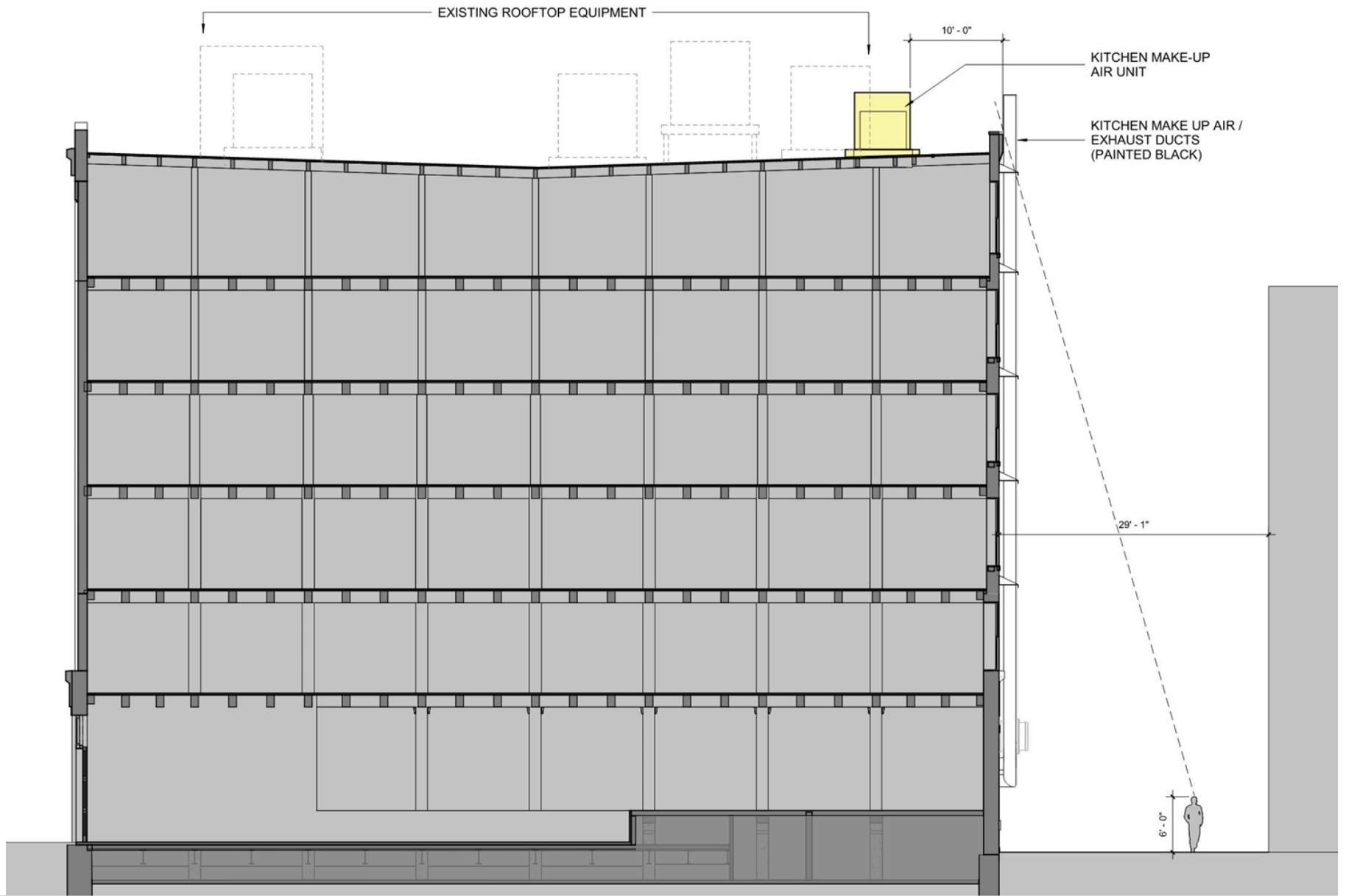

THOMSON PLACE

30 THOMSON PLACE

ALLEY

FARNSWORTH GARAGE

BUILDING CROSS SECTION SHOWING SIGHTLINES

02.08.2024

← PRIVATE ALLEY →

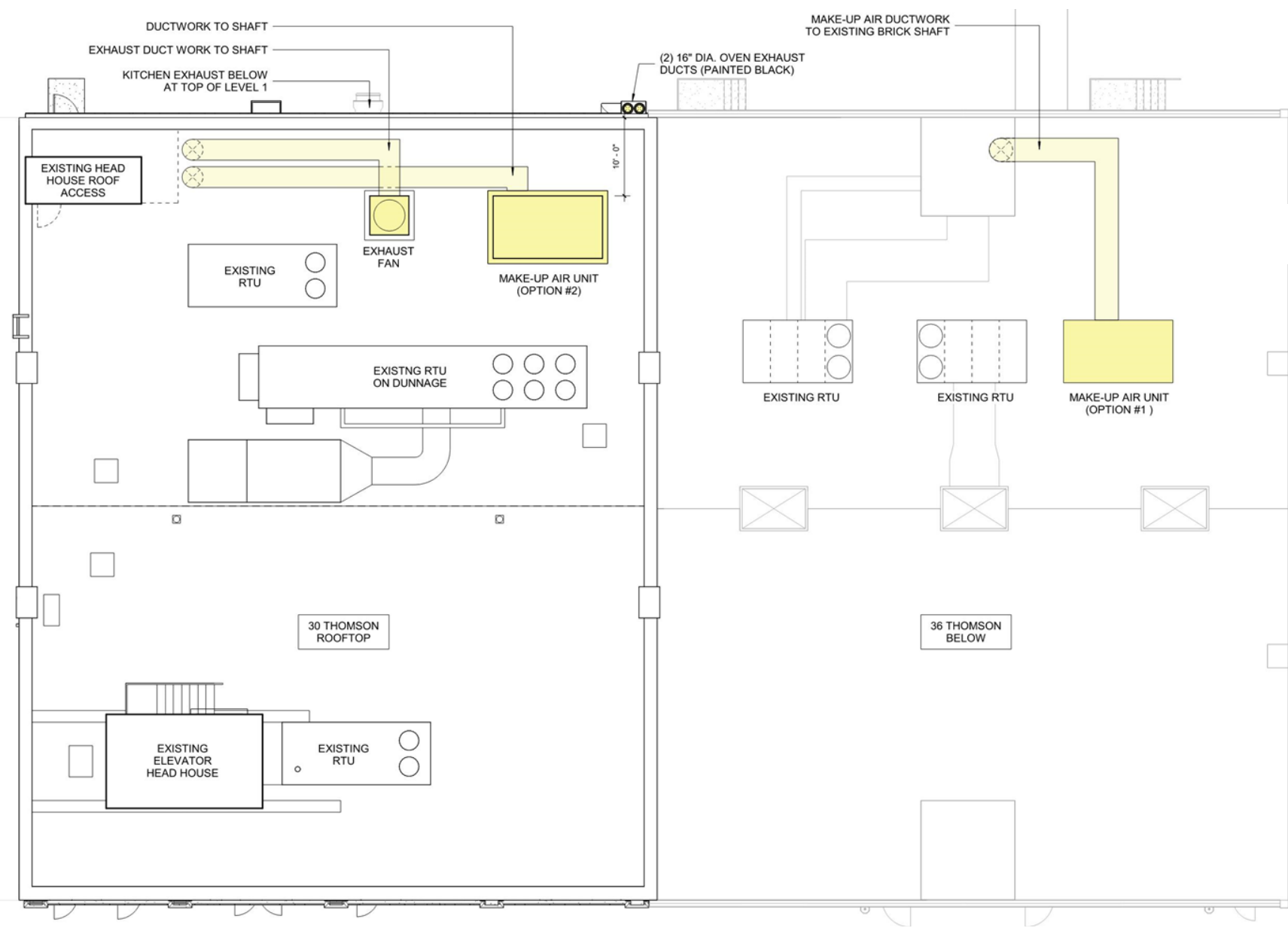

← THOMSON PLACE →

# ROOFTOP EQUIPMENT PLAN

02.08.2024



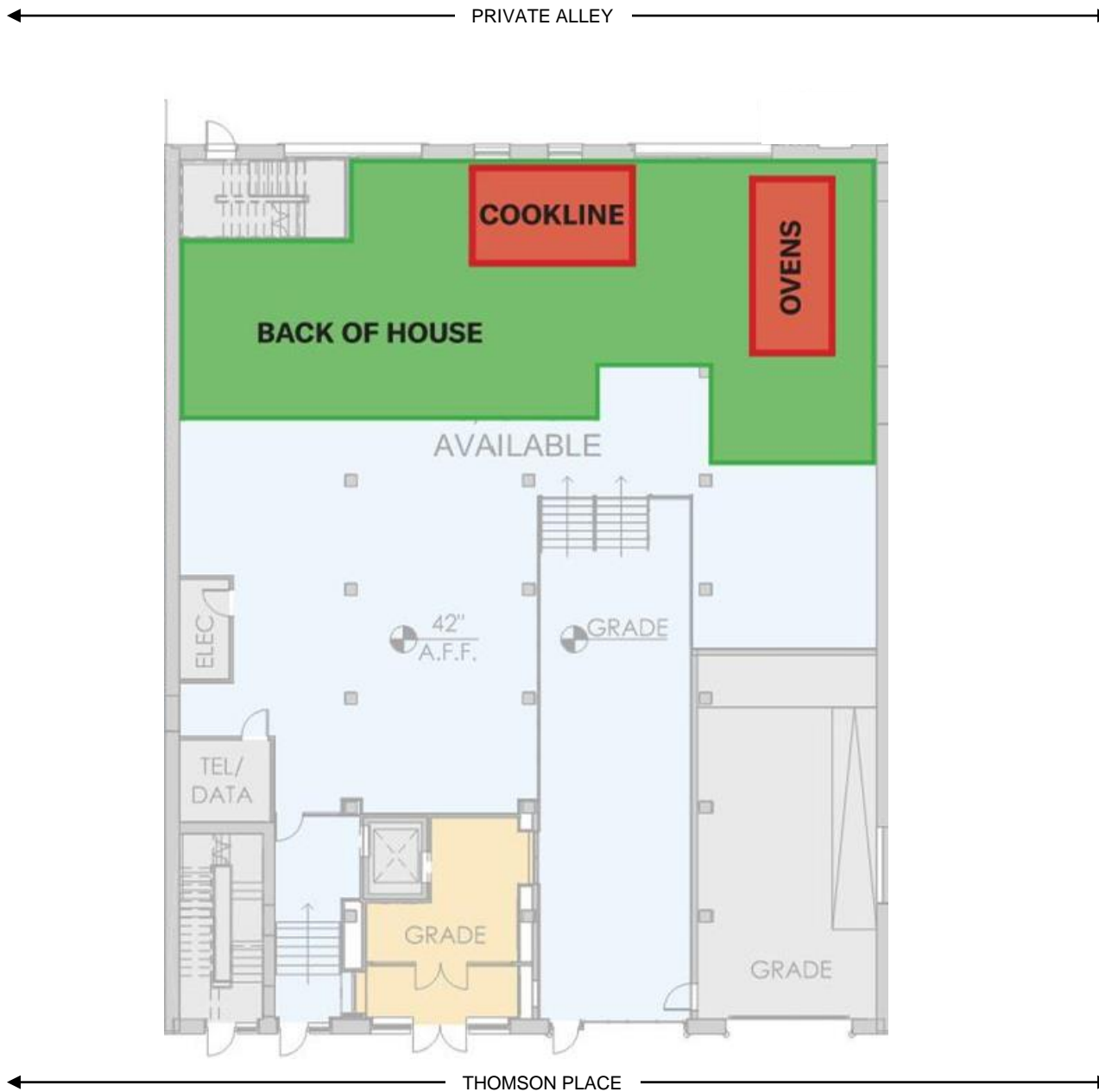

BUILDING CROSS SECTION SHOWING SIGHTLINES

02.08.2024

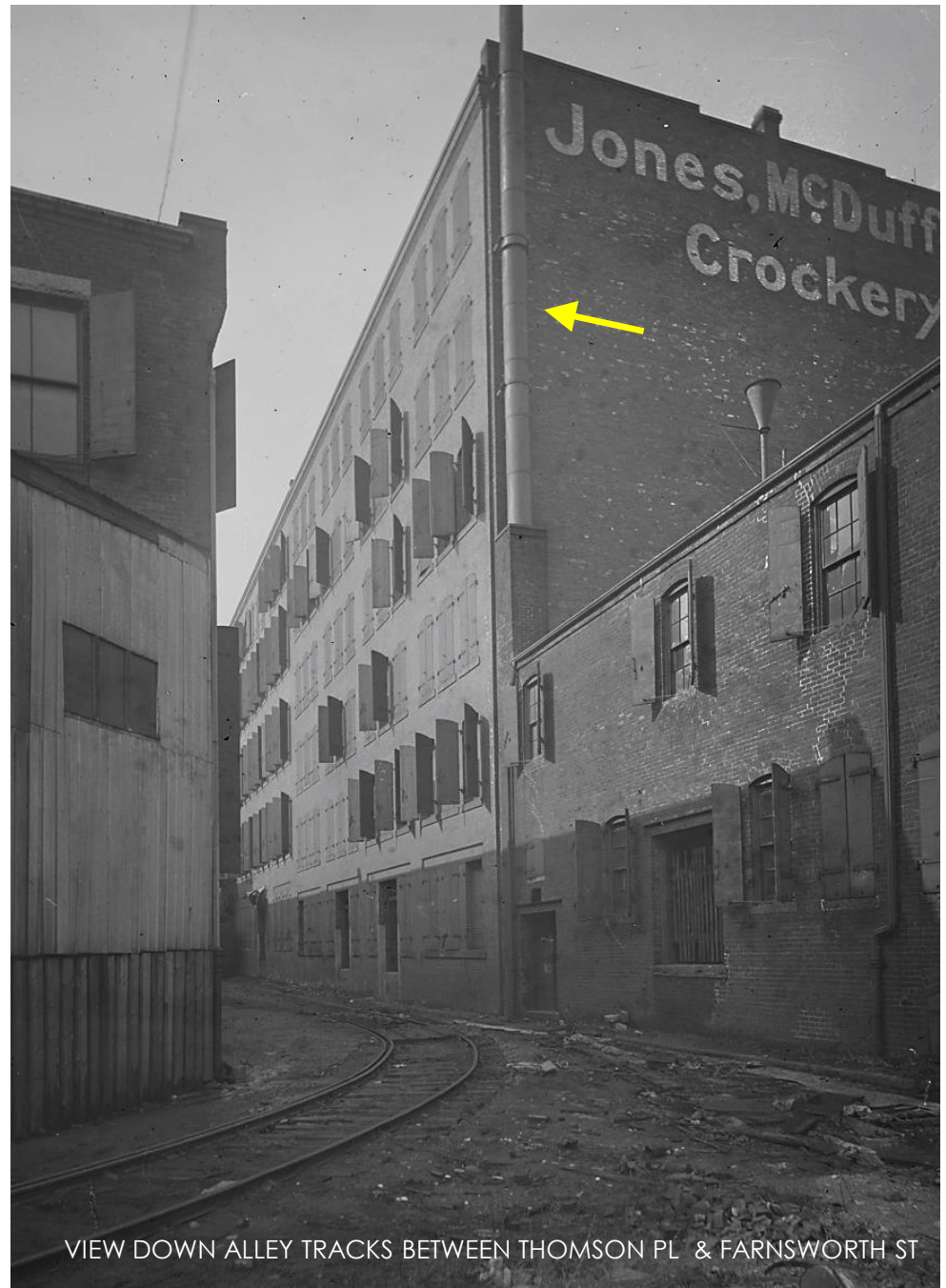
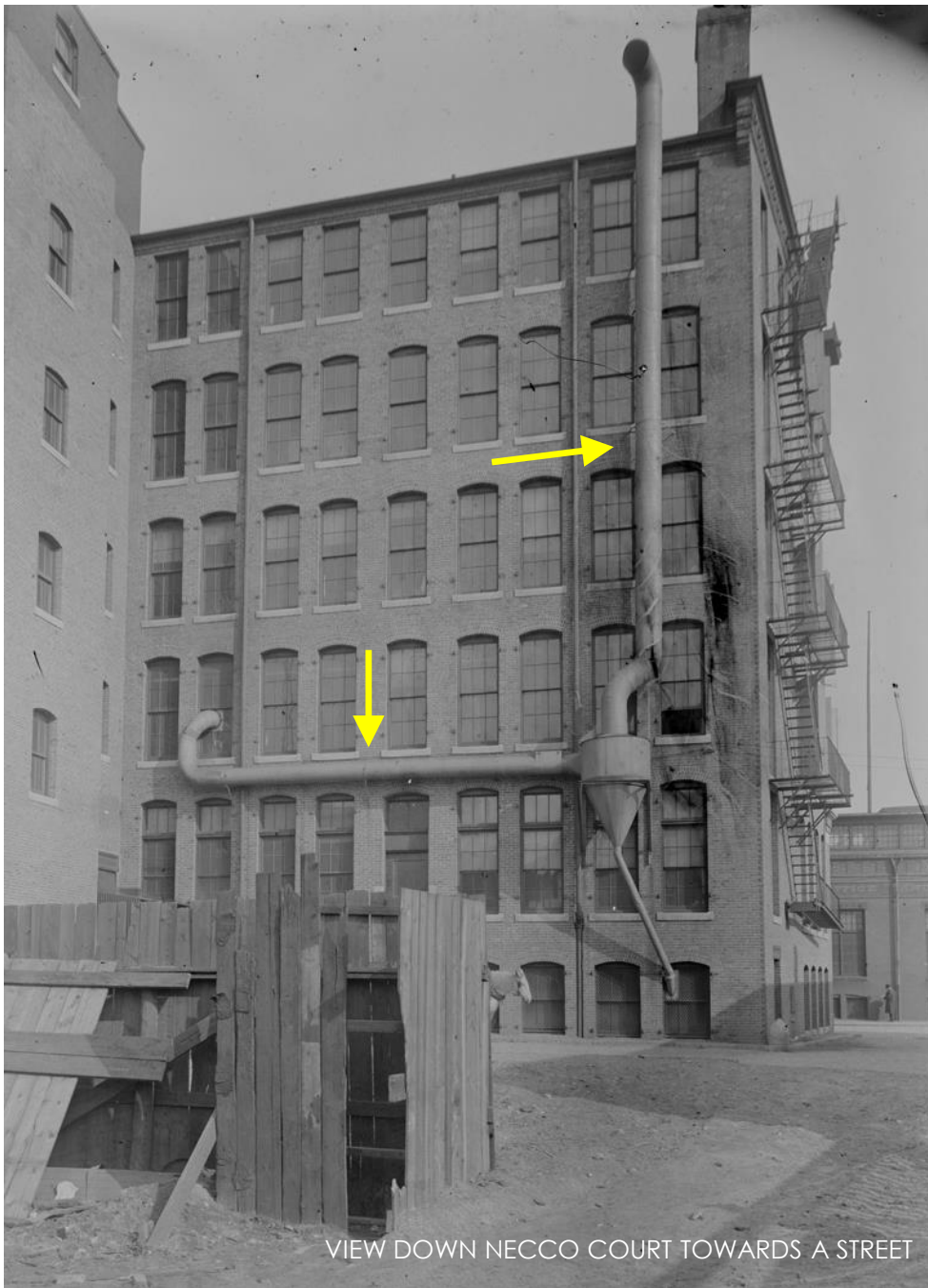

HISTORIC PHOTOS OF VENT STACKS FOR REFERENCE

02.08.2024



SURFACE MOUNTED DUCTWORK BEHIND "METRO" SPACE



SURFACE MOUNTED DUCTWORK BEHIND "LUCKY'S"

NEIGHBORHOOD PHOTOS OF DUCTWORK EXAMPLES

02.08.2024



CONDENSERS BEHIND 343 CONGRESS STREET

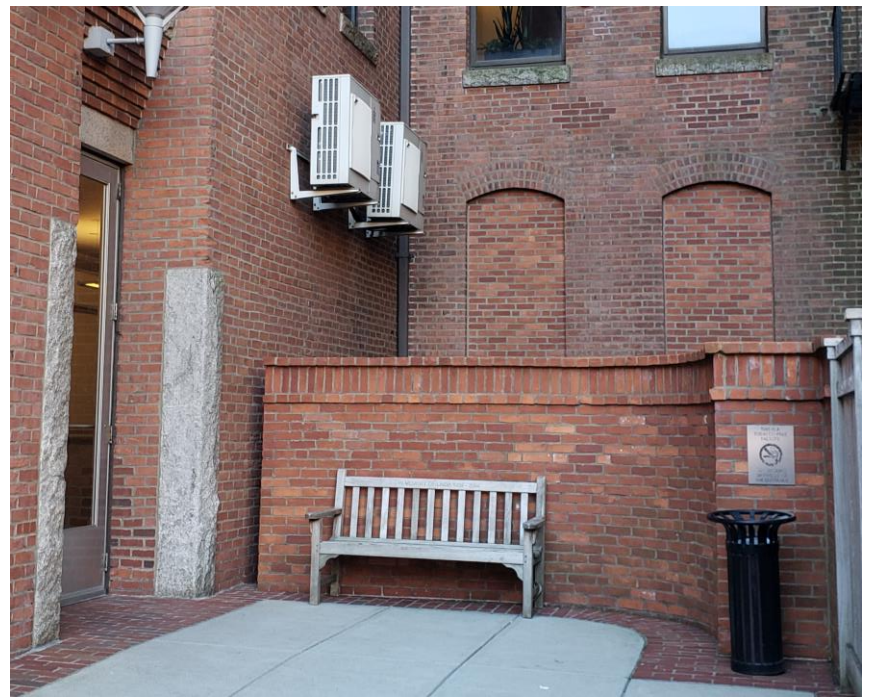

CONDENSERS BEHIND 274 SUMMER STREET



CONDENSERS BEHIND 281-283 SUMMER STREET



CONDENSERS AT 328 STREET

NEIGHBORHOOD PHOTOS OF WALL MOUNTED EQUIPMENT

02.08.2024

*Sally's* **PIZZA**

**THANK YOU**